



Chipsmall Limited consists of a professional team with an average of over 10 year of expertise in the distribution of electronic components. Based in Hongkong, we have already established firm and mutual-benefit business relationships with customers from,Europe,America and south Asia,supplying obsolete and hard-to-find components to meet their specific needs.

With the principle of “Quality Parts,Customers Priority,Honest Operation,and Considerate Service”,our business mainly focus on the distribution of electronic components. Line cards we deal with include Microchip,ALPS,ROHM,Xilinx,Pulse,ON,Everlight and Freescale. Main products comprise IC,Modules,Potentiometer,IC Socket,Relay,Connector.Our parts cover such applications as commercial,industrial, and automotives areas.

We are looking forward to setting up business relationship with you and hope to provide you with the best service and solution. Let us make a better world for our industry!



Contact us

Tel: +86-755-8981 8866 Fax: +86-755-8427 6832

Email & Skype: info@chipsmall.com Web: www.chipsmall.com

Address: A1208, Overseas Decoration Building, #122 Zhenhua RD., Futian, Shenzhen, China



High Reliability Slotted Optical Switch



OPB870, OPB871, OPB872 (TX, TXV)

Features:

- 0.125" (3.175 mm) slot width
- Choice of aperture (0.050" or 0.010" width)
- PCBoard mounting
- TX and TXV devices processed to MIL-PRF-19500
- S level processing available
- Hermetically sealed components

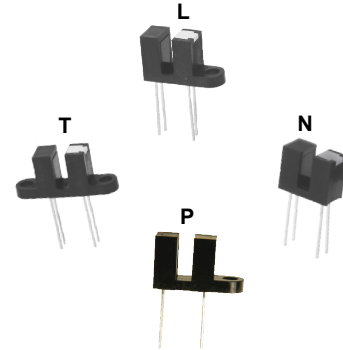

Description:

Each OPB870, OPB871 and OPB872 (TX, TXV) phototransistor device provides the flexibility of a custom device from a standard product line. Building from a standard housing with a 0.125" (3.175 mm) wide slot and 0.425" (mm) leads for PCBoard mounting, a user can choose aperture width, opaque or IR transmissive housing shell material and mounting tab configuration.

Housings are made from an opaque grade of injection-molded plastic to minimize sensitivity to both visible and near-infrared light. Discrete shells exposed on the parallel faces inside each device's throat are made from either IR transmissive plastic (for applications where dust protection is needed) or from opaque plastic with aperture openings (for applications that require maximum protection against ambient light).

TX and TXV devices are processed to OPTEK's military screening program patterned after MIL-PRF-19500.

Please refer to Application Bulletins 208 and 210 for additional design information and reliability (degradation) data.

Applications:

- Non-contact object sensing
- Assembly line automation
- Machine automation
- Equipment safety
- Machine safety
- Military and harsh environments

Part Number Guide — OPB870, OPB871, OPB872 (TX, TXV)

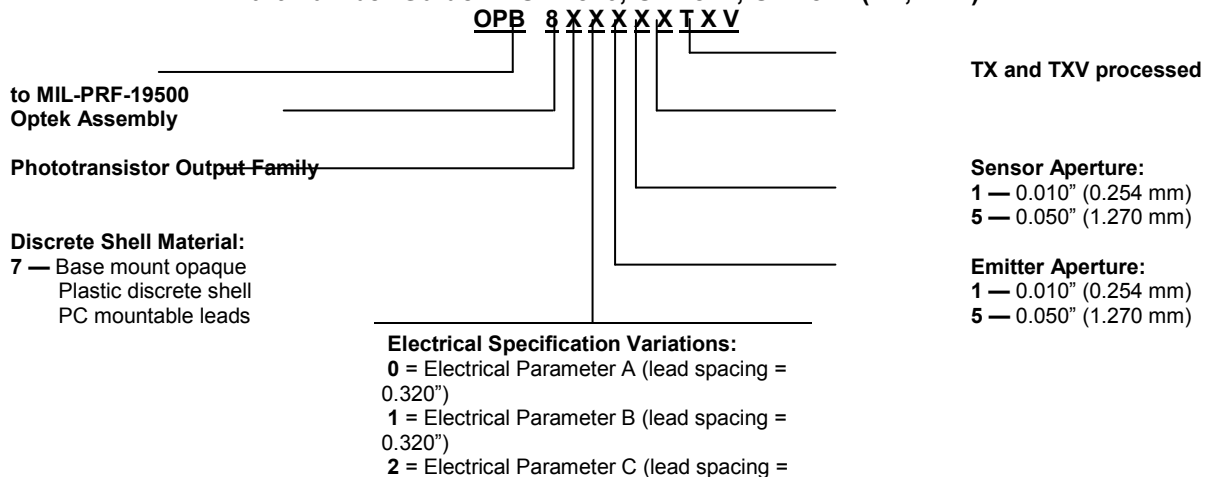

General Note

TT Electronics reserves the right to make changes in product specification without notice or liability. All information is subject to TT Electronics' own data and is considered accurate at time of going to print.

TT Electronics | Optek Technology, Inc.
 1645 Wallace Drive, Ste. 130, Carrollton, TX USA 75006 | Ph: +1 972 323 2200
www.ttelectronics.com | sensors@ttelectronics.com

Electrical Specifications

Absolute Maximum Ratings ($T_A = 25^\circ\text{C}$ unless otherwise noted)

Storage Temperature ⁽¹⁾	-65° C to +150° C
Operating Temperature ⁽¹⁾	-65° C to +125° C
Lead Soldering Temperature ⁽³⁾	240° C

Input LED

Forward DC Current	50 mA
Peak Forward Current (1 μ s pulse width, 300 pps)	1.0 A
Reverse DC Voltage	2.0 V
Power Dissipation ⁽²⁾	100 mW

Output Phototransistor/Diode

Collector-Emitter Voltage	50 V
Emitter-Collector Voltage	7.0 V
Collector DC Current	30 mA
Power Dissipation	100 mW ⁽²⁾

Notes:

- (1) Derate linearly 1.00 mW/° C above 25° C.
- (2) Cleaning agents methanol and isopropanol are recommended. Spray or wipe; do not submerge.
- (3) RMA flux is recommended. Duration can be extended to 10 seconds maximum when flow soldering.
- (4) All parameters were tested using pulse technique.

General Note

TT Electronics reserves the right to make changes in product specification without notice or liability. All information is subject to TT Electronics' own data and is considered accurate at time of going to print.

TT Electronics | Optek Technology, Inc.
1645 Wallace Drive, Ste. 130, Carrollton, TX USA 75006 | Ph: +1 972 323 2200
www.ttelectronics.com | sensors@ttelectronics.com

High Reliability Slotted Optical Switch



Electrical Characteristics (T_A = 25°C unless otherwise noted)

SYMBOL	PARAMETER	MIN	TYP	MAX	UNITS	TEST CONDITIONS
--------	-----------	-----	-----	-----	-------	-----------------

Input Transistor/Diode

V _F	Forward Voltage	1.00 1.20 0.80	- - -	1.70 1.90 1.60	V	I _F = 20.0 mA I _F = 20.0 mA, T _A = -55°C I _F = 20.0 mA, T _A = -100°C
I _R	Reverse Current	-	-	10	μA	V _R = 2.0 VDC

Output Transistor

V _{(BR)CEO}	Collector-Emitter Breakdown Voltage	50	-	-	V	I _C = 1.0 mA, I _F = 0
V _{(BR)ECO}	Emitter-Collector Breakdown Voltage	7.0	-	-	V	I _E = 100 μA, I _F = 0
I _{C(off)}	Collector-Emitter Dark Current	-	-	100 100	nA μA	V _{CE} = 10.0 V, I _F = 0 V _{CE} = 10.0 V, I _F = 0, T _A = 100°C

Coupled

I _{C(ON)}	On-State Collector Current ⁽⁴⁾					
	Parameter A OPB870 OPB870 OPB870	500 200 200	- - -	- - -	μA	V _{CE} = 10.0 V, I _F = 20.0 mA V _{CE} = 10.0 V, I _F = 20.0 mA, T _A = -55°C V _{CE} = 10.0 V, I _F = 20.0 mA, T _A = 100°C
	Parameter B OPB871 OPB871 OPB871	1000 400 400	- - -	- - -	μA	V _{CE} = 5.0 V, I _F = 10.0 mA V _{CE} = 5.0 V, I _F = 10.0 mA, T _A = -55°C V _{CE} = 5.0 V, I _F = 10.0 mA, T _A = 100°C
	Parameter C OPB872 OPB872 OPB872	1800 800 800	- - -	- - -	μA	V _{CE} = 0.4 V, I _F = 20.0 mA V _{CE} = 0.4 V, I _F = 20.0 mA, T _A = -55°C V _{CE} = 0.4 V, I _F = 20.0 mA, T _A = 100°C
V _{CE(SAT)}	Collector-Emitter Saturation Voltage OPB870 OPB871 OPB872	- - -	- - -	0.30 0.30 0.30	V	I _C = 400 μA, I _F = 20.0 mA I _C = 800 μA, I _F = 10.0 mA I _C = 1800 μA, I _F = 20.0 mA
t _r	Output Rise Time OPB870 OPB871 OPB872	- - -	- - -	15.0 20.0 20.0	μs	V _{CC} = 10.0 V I _F = 20.0 mA R _L = 1000Ω
t _f	Output Fall Time OPB870 OPB871 OPB872	- - -	- - -	15.0 20.0 20.0	μs	V _{CC} = 10.0 V I _F = 20.0 mA R _L = 1000Ω

General Note

TT Electronics reserves the right to make changes in product specification without notice or liability. All information is subject to TT Electronics' own data and is considered accurate at time of going to print.

TT Electronics | Optek Technology, Inc.
1645 Wallace Drive, Ste. 130, Carrollton, TX USA 75006 | Ph: +1 972 323 2200
www.ttelectronics.com | sensors@ttelectronics.com

High Reliability Slotted Optical Switch



Packaging

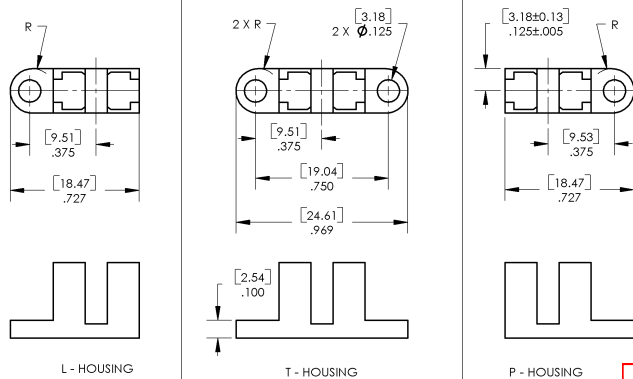
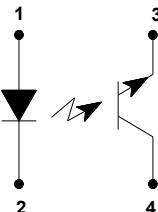
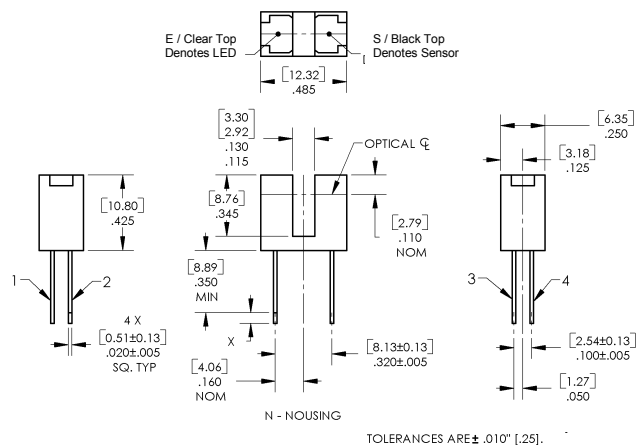

DIMENSIONS ARE IN: [MILLIMETERS]
INCHES

Pin #	Emitter	Pin #	Transistor/Diode
1	Anode	3	Collector / Anode
2	Cathode	4	Emitter / Cathode

CONTAINS POLYSULFONE

To avoid stress cracking, we suggest using ND Industries' **Vibra-Tite** for thread-locking. **Vibra-Tite** evaporates fast without causing structural failure in OPTEK's molded plastics.

General Note

TT Electronics reserves the right to make changes in product specification without notice or liability. All information is subject to TT Electronics' own data and is considered accurate at time of going to print.

TT Electronics | Optek Technology, Inc.
1645 Wallace Drive, Ste. 130, Carrollton, TX USA 75006 | Ph: +1 972 323 2200
www.ttelectronics.com | sensors@ttelectronics.com

High Reliability Slotted Optical Switch



Aperture Configuration 51 - Flag Next to Emitter

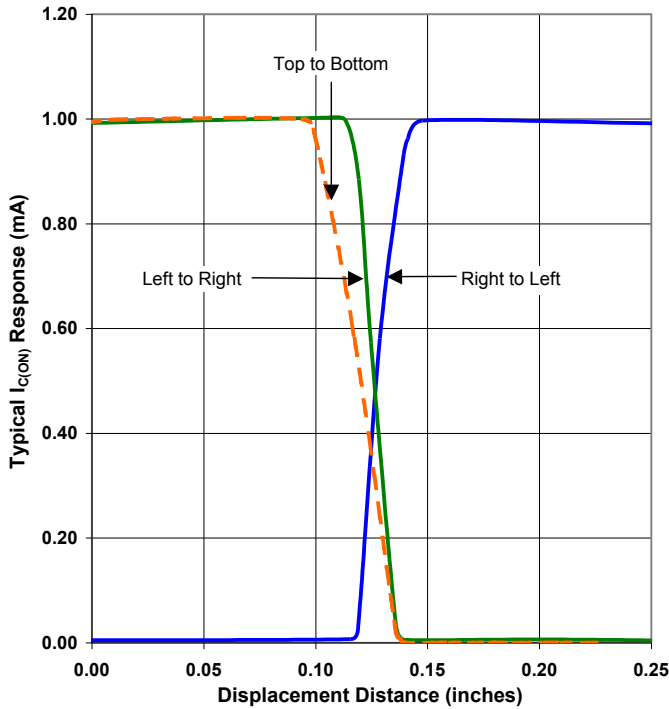

Aperture Configuration 51 - Flag Next to Sensor

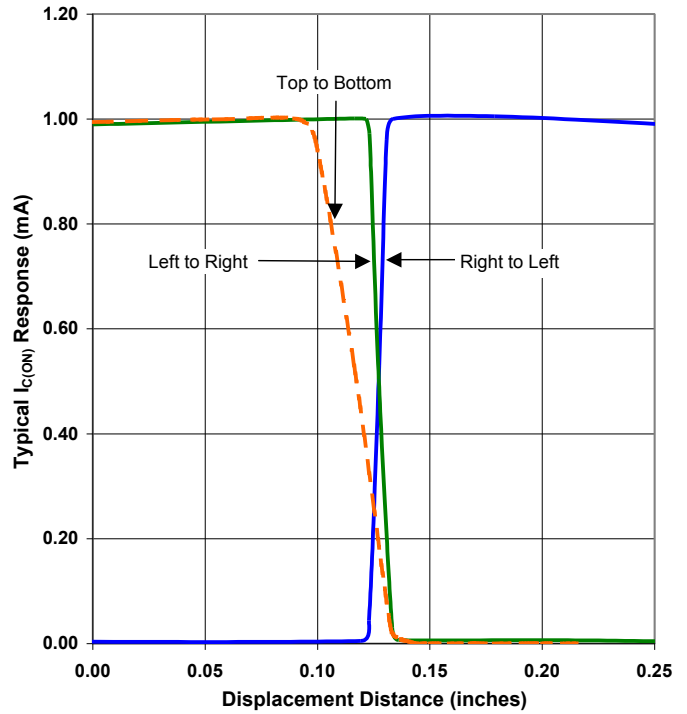

Aperture Configuration 51 - Flag in Middle of Slot

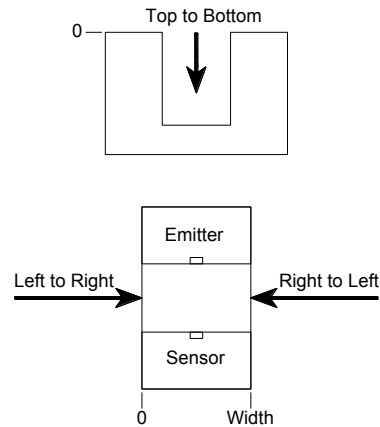
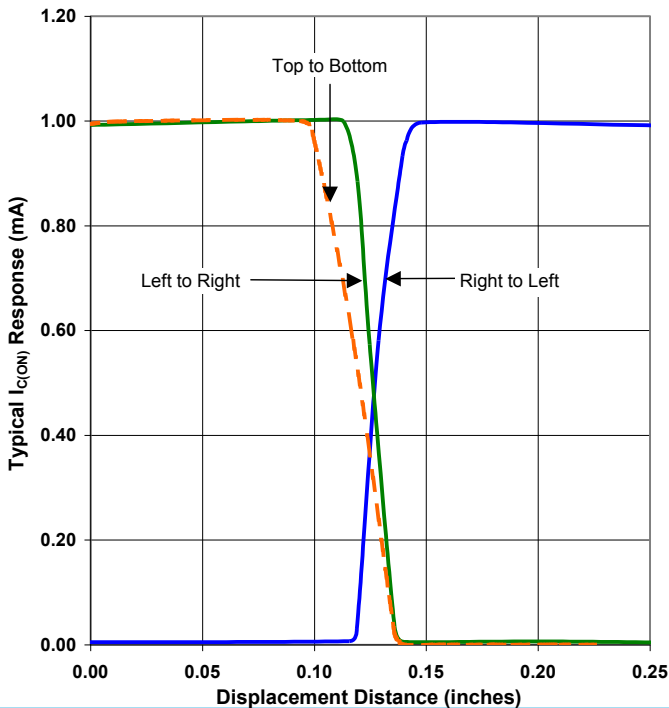

General Note
 TT Electronics reserves the right to make changes in product specification without notice or liability. All information is subject to TT Electronics' own data and is considered accurate at time of going to print.

TT Electronics | Optek Technology, Inc.
 1645 Wallace Drive, Ste. 130, Carrollton, TX USA 75006 | Ph: +1 972 323 2200
www.ttelectronics.com | sensors@ttelectronics.com

High Reliability Slotted Optical Switch



Aperture Configuration 55 - Flag Next to Emitter

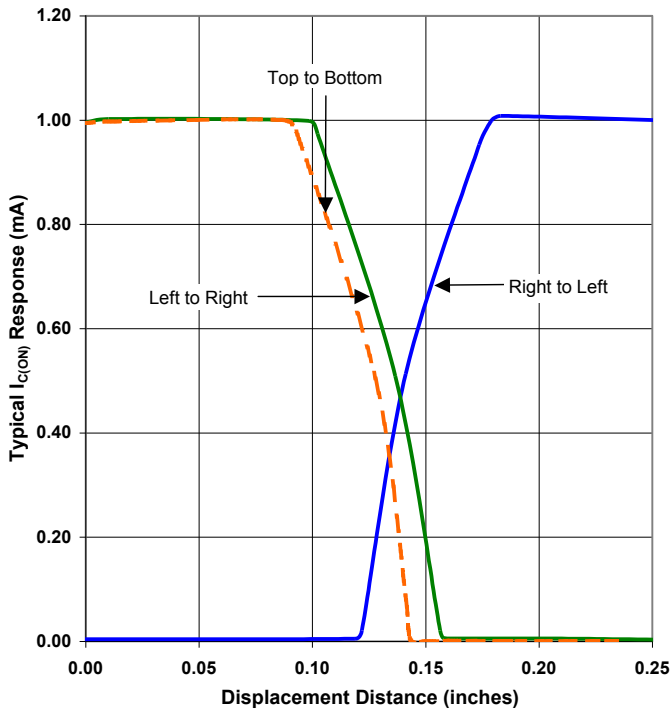

Aperture Configuration 55 - Flag Next to Sensor

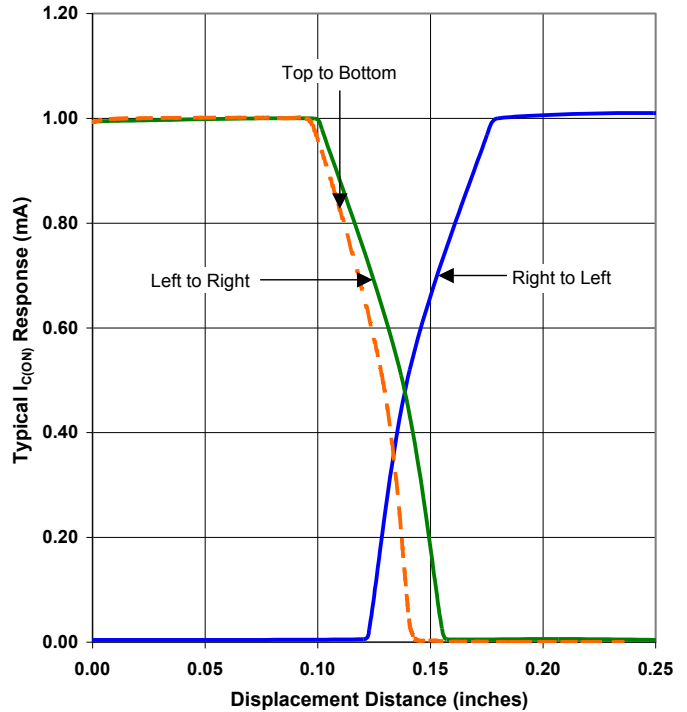

Aperture Configuration 55 - Flag in Middle of Slot

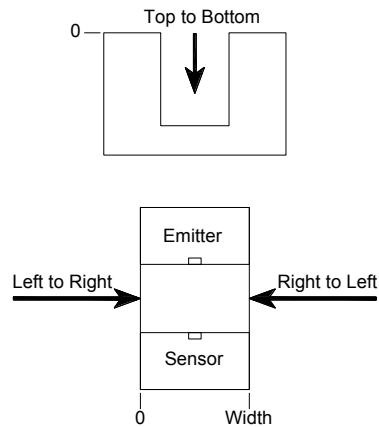
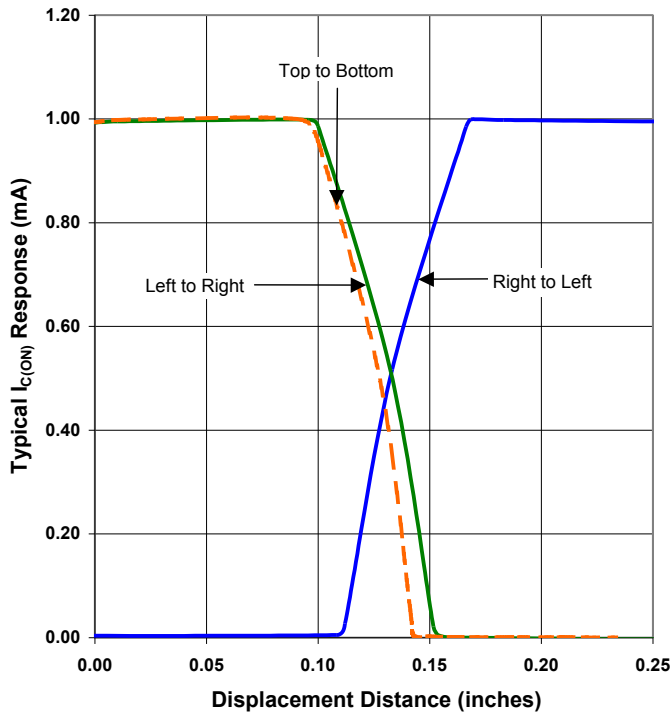

General Note
 TT Electronics reserves the right to make changes in product specification without notice or liability. All information is subject to TT Electronics' own data and is considered accurate at time of going to print.

TT Electronics | Optek Technology, Inc.
 1645 Wallace Drive, Ste. 130, Carrollton, TX USA 75006 | Ph: +1 972 323 2200
www.ttelectronics.com | sensors@ttelectronics.com