



Chipsmall Limited consists of a professional team with an average of over 10 year of expertise in the distribution of electronic components. Based in Hongkong, we have already established firm and mutual-benefit business relationships with customers from,Europe,America and south Asia,supplying obsolete and hard-to-find components to meet their specific needs.

With the principle of “Quality Parts,Customers Priority,Honest Operation,and Considerate Service”,our business mainly focus on the distribution of electronic components. Line cards we deal with include Microchip,ALPS,ROHM,Xilinx,Pulse,ON,Everlight and Freescale. Main products comprise IC,Modules,Potentiometer,IC Socket,Relay,Connector.Our parts cover such applications as commercial,industrial, and automotives areas.

We are looking forward to setting up business relationship with you and hope to provide you with the best service and solution. Let us make a better world for our industry!



Contact us

Tel: +86-755-8981 8866 Fax: +86-755-8427 6832

Email & Skype: info@chipsmall.com Web: www.chipsmall.com

Address: A1208, Overseas Decoration Building, #122 Zhenhua RD., Futian, Shenzhen, China



Photologic® Slotted Optical Switch

OPB930 and OPB940 (L and W Series)

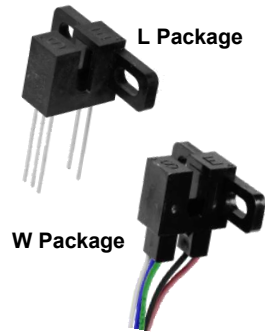

Features:

- Choice of aperture size
- Choice of output configurations
- Choice of opaque or IR transmissive shell
- Choice of pins (L) or wires (W)
- 0.125" (3.18 mm) slot width
- 0.320" (8.128 mm) lead spacing for PCBoard (side mounting)
- Data rates to 250 kBaud

Description:

The **OPB930** and **OPB940** series of Photologic® photo integrated circuit switches provide optimum flexibility for the design engineer. Building from a standard housing with a 0.125" (3.18 mm) wide slot, a user can specify the type and polarity of TTL output, discrete shell material, aperture width and either 0.350" (8.9 mm) long pins (**L Series**) or 24" (610 mm) AWG, UL listed wire leads (**W Series**).

All housings are made from an opaque grade of injection-molded plastic that minimizes the assembly's sensitivity to both visible and near-infrared ambient radiation. Discrete shells (exposed on the parallel faces inside the device throat) are either IR transmissive plastic (for applications where aperture contamination may occur) or opaque plastic (for maximum protection against ambient light).

Electrical output can be specified as either TTL Totem Pole or TTL Open Collector, either of which can be supplied with buffer or inverter output polarity. All devices have the added stability of a built-in hysteresis amplifier.

Custom electrical, wire and cabling and connectors are available. Contact your local representative or OPTEK for more information.

Applications:

- Mechanical switch replacement
- Speed indication (tachometer)
- Mechanical limit indication

Part Number Guide — OPB930 and OPB940 Series

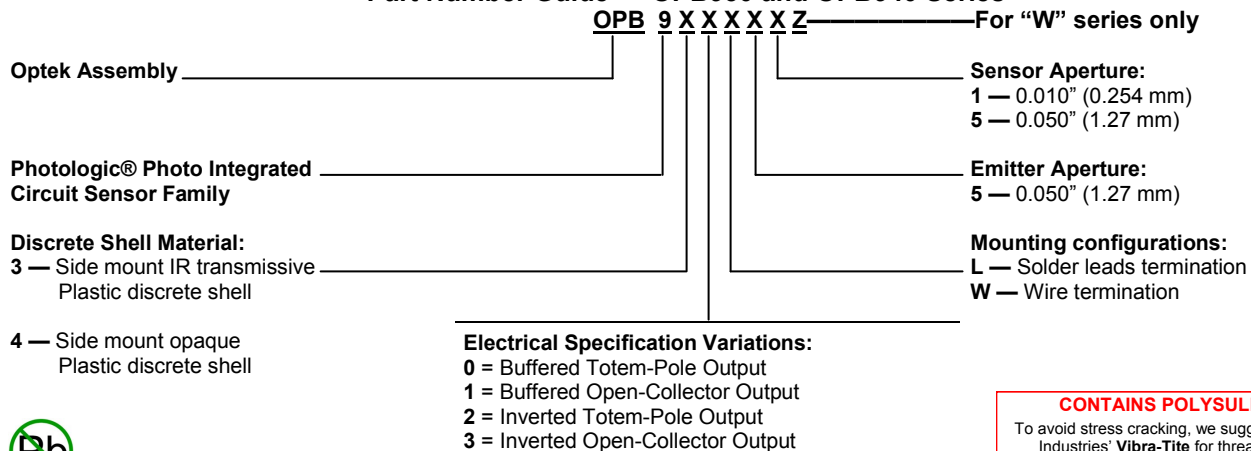

CONTAINS POLYSULFONE

To avoid stress cracking, we suggest using ND Industries' **Vibra-Tite** for thread-locking. **Vibra-Tite** evaporates fast without causing structural failure in OPTEK's molded plastics.



General Note
TT Electronics reserves the right to make changes in product specification without notice or liability. All information is subject to TT Electronics' own data and is considered accurate at time of going to print.

OPTEK Technology, Inc.
1645 Wallace Drive, Carrollton, TX 75006 | Ph: +1 972 323 2200
www.optekinc.com | www.ttelectronics.com

Photologic® Slotted Optical Switch



OPB930, OPB940 Buffered Totem-Pole

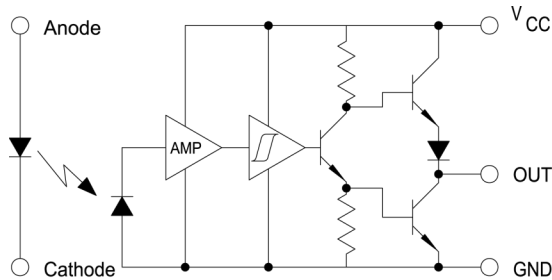

OPB931, OPB941 Buffered Open-Collector

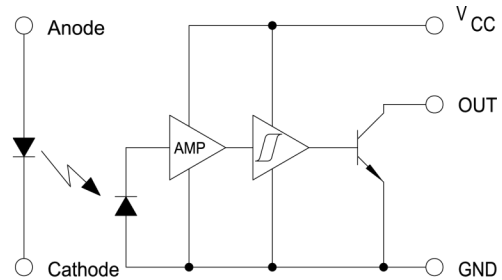

OPB932, OPB942 Inverted Totem-Pole

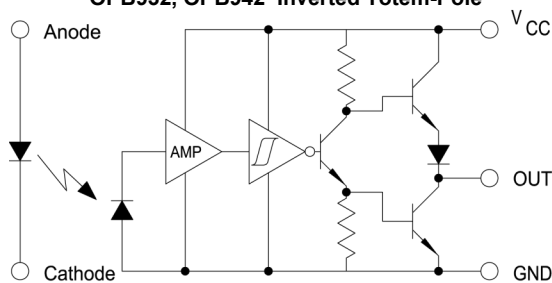

OPB933 & OPB943 Inverted Open-Collector

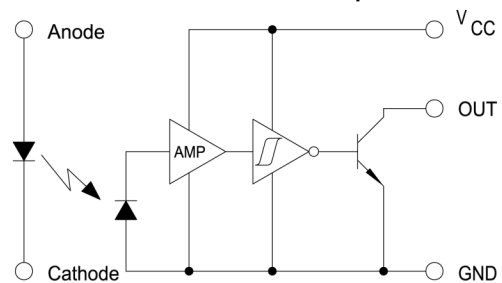

Absolute Maximum Ratings ($T_A = 25^\circ\text{C}$ unless otherwise noted)

| | |
|---|--|
| Supply Voltage, V_{CC} (not to exceed 3 seconds) | 10 V |
| Operating Temperature Range | -40°C to $+70^\circ\text{C}$ |
| Storage Temperature Range | -40°C to $+85^\circ\text{C}$ |
| Lead Soldering Temperature (1/16 inch (1.6mm) from the case for 5 sec. with soldering iron ⁽¹⁾) | 260°C |
| Input Infrared LED | |
| Input Diode Power Dissipation ⁽²⁾ | 100 mW |
| Output Photologic® Power Dissipation ⁽³⁾ | 200 mW |
| Total Device Power Dissipation ⁽⁴⁾ | 300 mW |
| Output Photologic® | |
| Voltage at Output Lead (Open Collector Output) | 35 V |
| Diode Forward DC Current | 40 mA |
| Diode Reverse DC Voltage | 2 V |

Notes:

- (1) RMA flux is recommended. Duration can be extended to 10 seconds maximum when flow soldering.
- (2) Derate linearly 2.22 mW/ $^\circ\text{C}$ above 25° .
- (3) Derate linearly 4.44 mW/ $^\circ\text{C}$ above 25° .
- (4) Derate linearly 6.66 mW/ $^\circ\text{C}$ above 25° .
- (5) OPB930L/OPB940L series devices are terminated with 0.020" square leads designed for PCBoard mounting.
- (6) Methanol and isopropanol are recommended as cleaning agents. Plastic housing is soluble in chlorinated hydrocarbons and ketones.
- (7) All parameters tested using pulse technique.

General Note

TT Electronics reserves the right to make changes in product specification without notice or liability. All information is subject to TT Electronics' own data and is considered accurate at time of going to print.

OPTEK Technology, Inc.
1645 Wallace Drive, Carrollton, TX 75006 | Ph: +1 972 323 2200
www.optekinc.com | www.ttelectronics.com

Photologic® Slotted Optical Switch

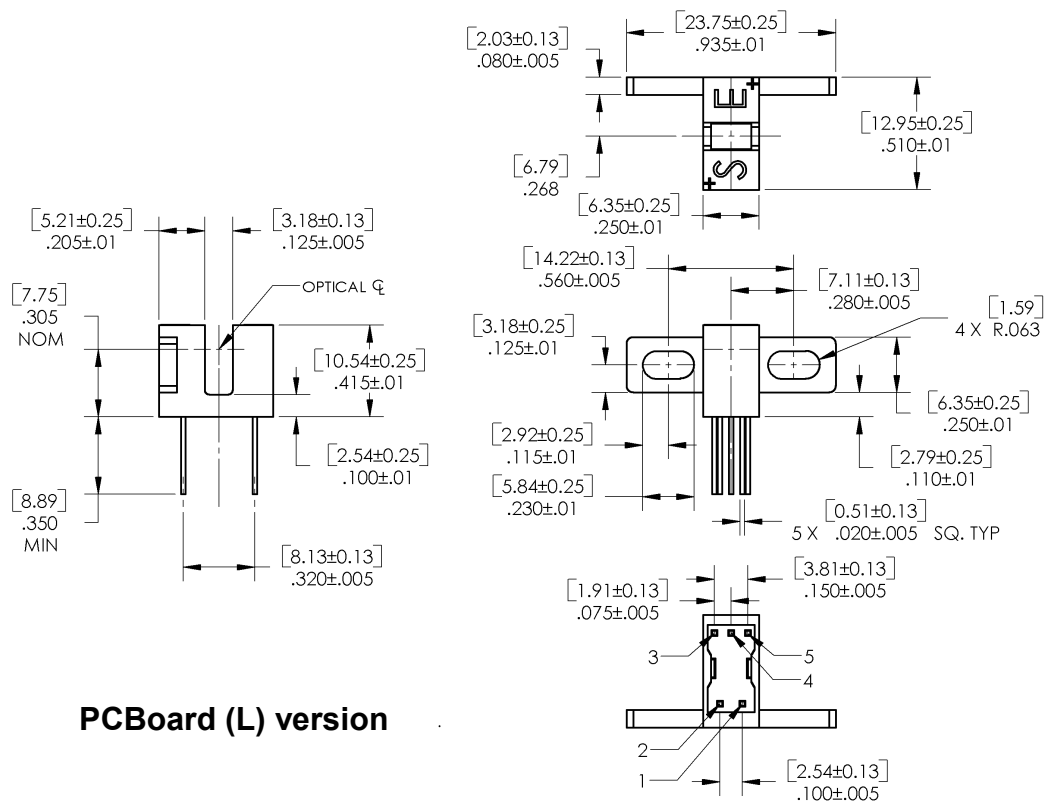

| Color- Pin # | Description |
|--------------|-----------------|
| Red—1 | Anode |
| Black—2 | Cathode |
| White—3 | V _{CC} |
| Blue—4 | Output |
| Green—5 | Ground |

DIMENSIONS ARE IN: [MILLIMETERS]
[INCHES]

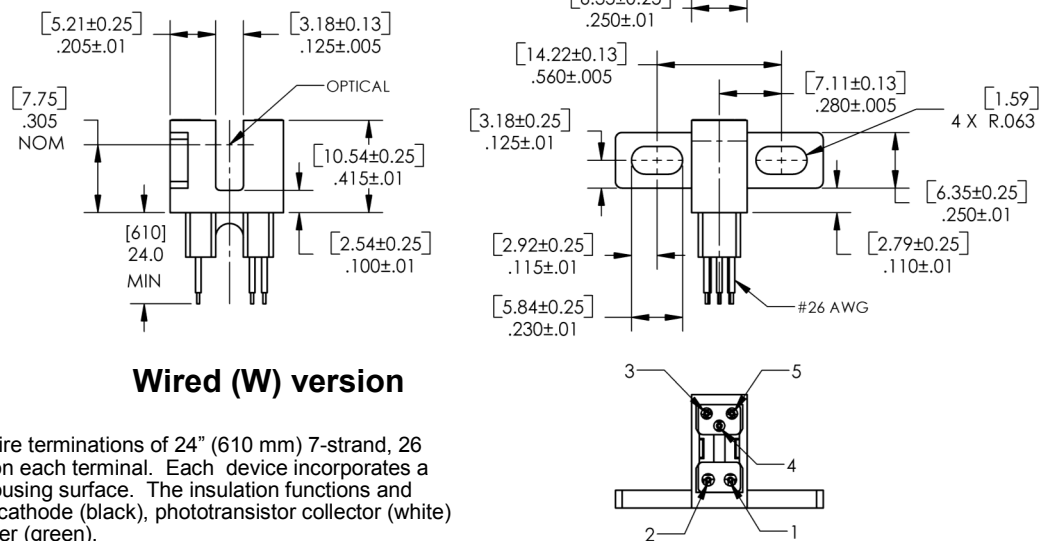

The W Series includes wire terminations of 24" (610 mm) 7-strand, 26 AWG UL insulated wire on each terminal. Each device incorporates a wire strain relief at the housing surface. The insulation functions and colors are: anode (red), cathode (black), phototransistor collector (white) and phototransistor emitter (green).

General Note
TT Electronics reserves the right to make changes in product specification without notice or liability. All information is subject to TT Electronics' own data and is considered accurate at time of going to print.

OPTEK Technology, Inc.
1645 Wallace Drive, Carrollton, TX 75006 | Ph: +1 972 323 2200
www.optekinc.com | www.ttelectronics.com

Electrical Characteristics ($T_A = 25^\circ\text{C}$ unless otherwise noted)

| SYMBOL | PARAMETER | MIN | TYP | MAX | UNITS | TEST CONDITIONS |
|---|--|------|-----|------|---------------|---|
| Input Diode | | | | | | |
| V_F | Forward Voltage | - | - | 1.7 | V | $I_F = 20\text{ mA}$ |
| I_R | Reverse Current | - | - | 100 | μA | $V_R = 2.0\text{ V}$ |
| Output Photologic[®] Sensor | | | | | | |
| V_{CC} | Operating D.C. Supply Voltage | 4.75 | - | 5.25 | V | - |
| I_{CCL} | Low Level Supply Current: Totem Pole & Open-Collector | - | - | 15 | mA | $V_{CC} = 5.25, I_F = 0\text{ mA}^{(1)}$ |
| | Inverted Totem-Pole & Inverted Open-Collector | - | - | 15 | mA | $V_{CC} = 5.25, I_F = 15\text{ mA}$ |
| I_{CCH} | High Level Supply Current: Totem Pole & Open-Collector | - | - | 15 | mA | $V_{CC} = 5.25, I_F = 15\text{ mA}$ |
| | Inverted Totem-Pole & Inverted Open-Collector | - | - | 15 | mA | $V_{CC} = 5.25, I_F = 0\text{ mA}^{(1)}$ |
| V_{OL} | Low Level Output Voltage: Totem Pole & Open-Collector | - | - | 0.4 | V | $V_{CC} = 4.75, I_{OL} = 12.8\text{ mA}, I_F = 0\text{ mA}^{(1)}$ |
| | Inverted Totem-Pole & Inverted Open-Collector | - | - | 0.4 | V | $V_{CC} = 4.75, I_{OL} = 12.8\text{ mA}, I_F = 15\text{ mA}$ |
| V_{OH} | High Level Output Voltage: Totem-Pole & Open-Collector | 2.4 | - | - | V | $V_{CC} = 4.75, I_{OH} = -800\ \mu\text{A}, I_F = 15\text{ mA}$ |
| | Inverted Totem-Pole & Inverted Open-Collector | 2.4 | - | - | V | $V_{CC} = 4.75, I_{OH} = -800\ \mu\text{A}, I_F = 0\text{ mA}^{(1)}$ |
| I_{OH} | High Level Output Current: Totem Pole & Open-Collector | - | - | 100 | μA | $V_{CC} = 4.75, V_{OH} = 30\text{ V}, I_F = 15\text{ mA},$ |
| | Inverted Totem-Pole & Inverted Open-Collector | - | - | 100 | μA | $V_{CC} = 4.75, V_{OH} = 30\text{ V}, I_F = 0\text{ mA}^{(1)}$ |
| $I_F(+)$ | LED Positive-Going Threshold Current | - | - | 15 | mA | $V_{CC} = 5.0\text{ V}$ |
| $I_F(+), I_F(-)$ | Hysteresis | - | 2.0 | - | V | $V_{CC} = 5.0\text{ V}$ |
| I_{OS} | Short Circuit Output Current: Totem Pole & Open-Collector | -15 | - | -60 | mA | $V_{CC} = 5.25\text{ V}, I_F = 15\text{ mA}, \text{Output} = \text{GND}$ |
| | Inverted Totem-Pole & Inverted Open-Collector | -15 | - | -60 | mA | $V_{CC} = 5.25\text{ V}, I_F = 0\text{ mA}^{(1)}, \text{Output} = \text{GND}$ |

General Note

TT Electronics reserves the right to make changes in product specification without notice or liability. All information is subject to TT Electronics' own data and is considered accurate at time of going to print.

OPTEK Technology, Inc.
1645 Wallace Drive, Carrollton, TX 75006 | Ph: +1 972 323 2200
www.optekinc.com | www.ttelectronics.com

Electrical Characteristics ($T_A = 25^\circ\text{C}$ unless otherwise noted)

| SYMBOL | PARAMETER | MIN | TYP | MAX | UNITS | TEST CONDITIONS |
|------------|------------------------------------|-----|-----|-----|---------------|--|
| t_r, t_f | Output Rise Time, Output Fall Time | - | 70 | - | ns | $V_{CC} = 5\text{ V}$, $I_F = 0$ or 15 mA |
| T_{PLH} | Propagation Delay Low-High | - | 5.0 | - | μs | $R_L = 8\text{TTL loads (Totem Pole)}$ |
| T_{PHL} | Propagation Delay High-Low | - | 5.0 | - | μs | $R_L = 360\ \Omega$ (Open-Collector) |

Notes:

- (1) Normal application would be with light source blocked, simulated by $I_F = 0$ mA.
- (2) All parameters are tested using pulse techniques.

General Note

TT Electronics reserves the right to make changes in product specification without notice or liability. All information is subject to TT Electronics' own data and is considered accurate at time of going to print.

OPTEK Technology, Inc.
1645 Wallace Drive, Carrollton, TX 75006 | Ph: +1 972 323 2200
www.optekinc.com | www.ttelectronics.com

OPB930_11, OPB940_11 - Flag Next to Emitter

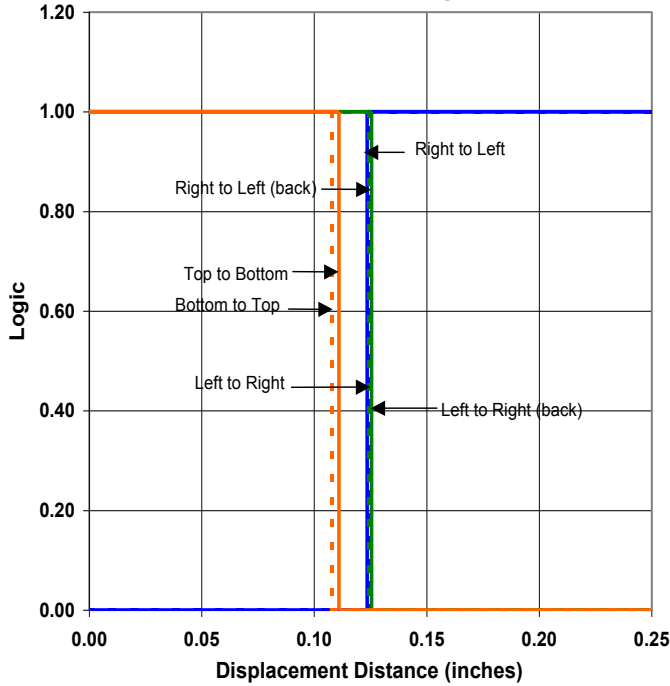

OPB930_11, OPB940_11 - Flag Next to Sensor

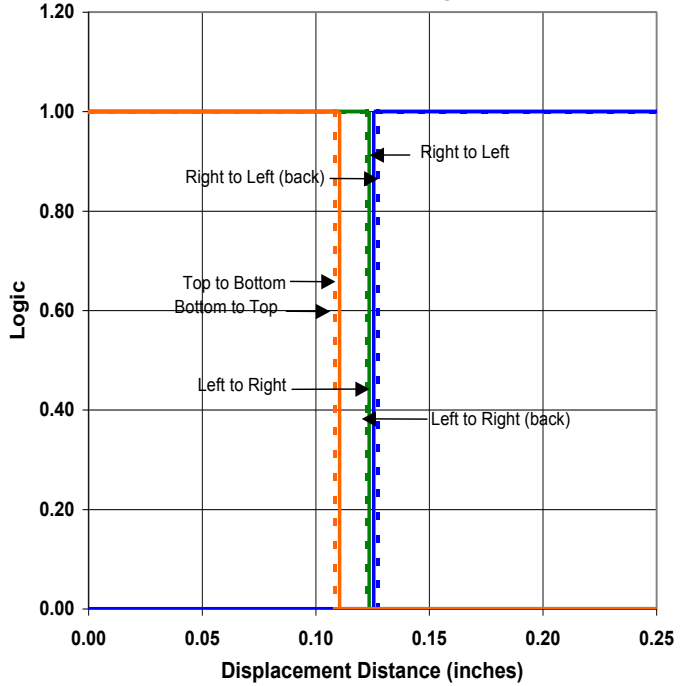

OPB930_11, OPB940_11 - Flag in Middle of Slot

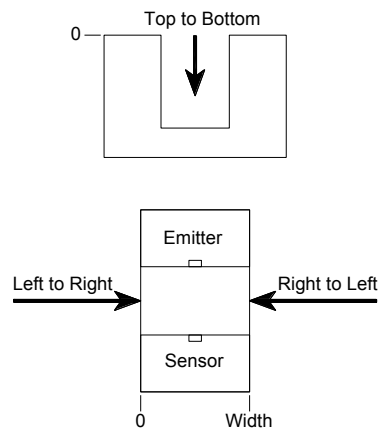
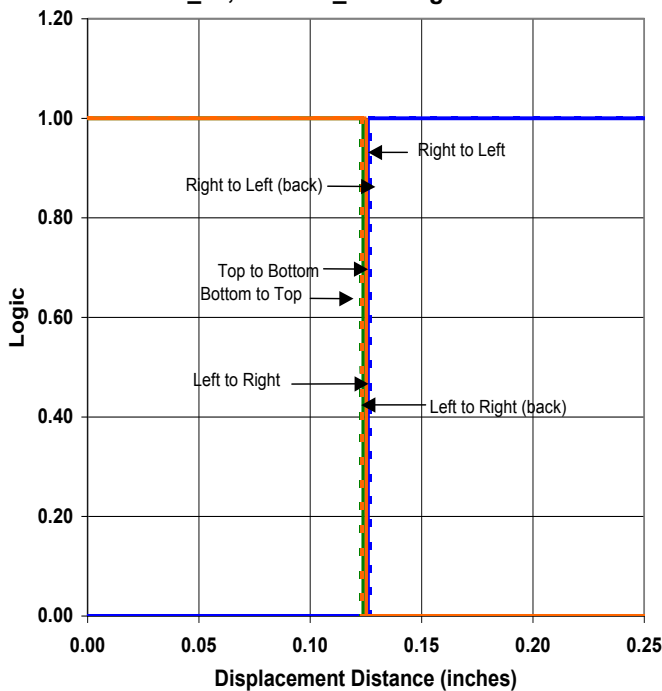

General Note
 TT Electronics reserves the right to make changes in product specification without notice or liability. All information is subject to TT Electronics' own data and is considered accurate at time of going to print.

OPTEK Technology, Inc.
 1645 Wallace Drive, Carrollton, TX 75006 | Ph: +1 972 323 2200
www.optekinc.com | www.ttelectronics.com

OPB930_51, OPB940_51 - Flag Next to Emitter

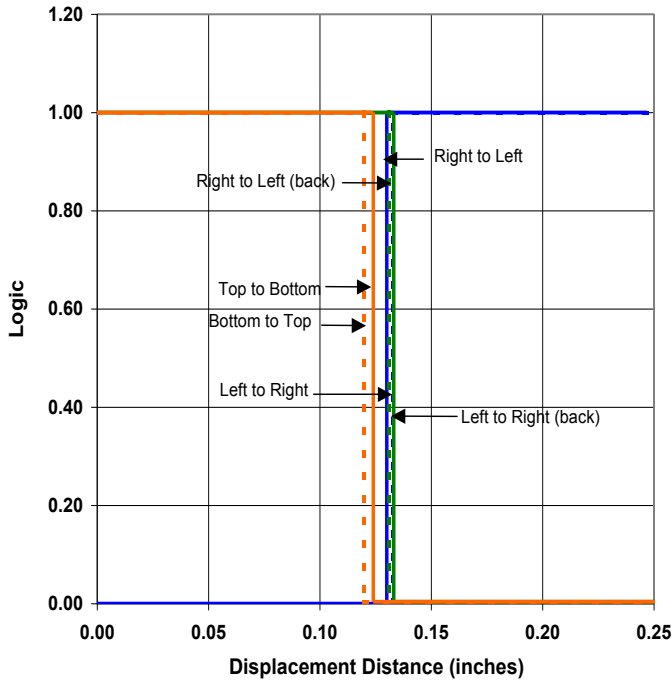

OPB930_51, OPB940_51 - Flag Next to Sensor

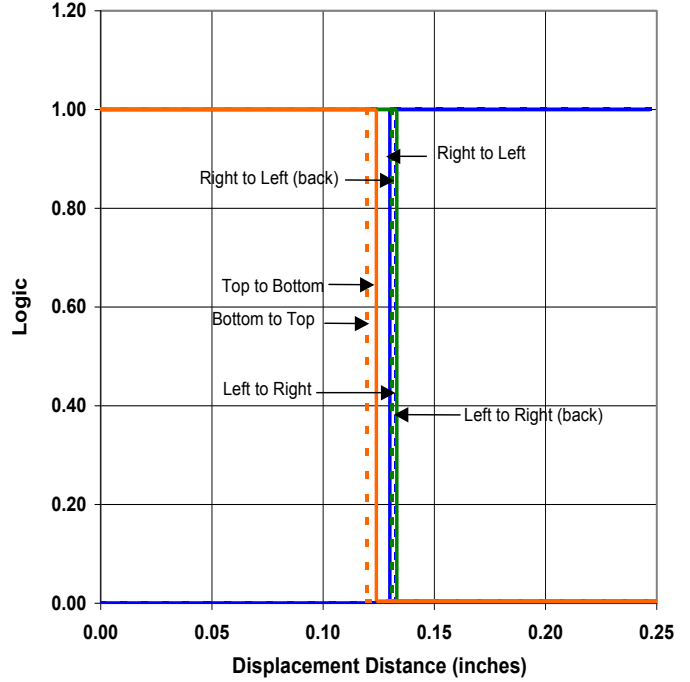

OPB930_51, OPB940_51 - Flag in Middle of Slot

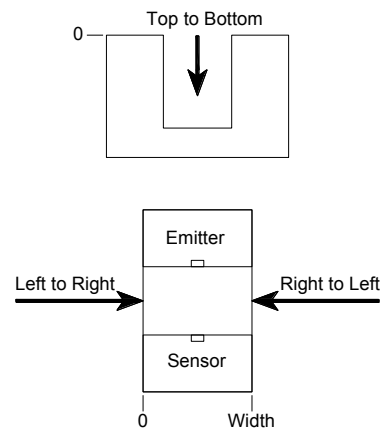
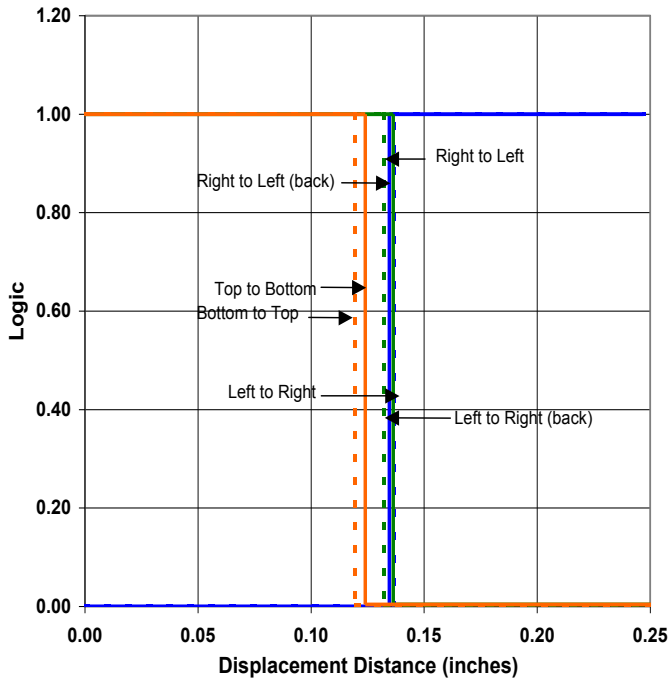

General Note
TT Electronics reserves the right to make changes in product specification without notice or liability. All information is subject to TT Electronics' own data and is considered accurate at time of going to print.

OPB930_55, OPB940_55 - Flag Next to Emitter

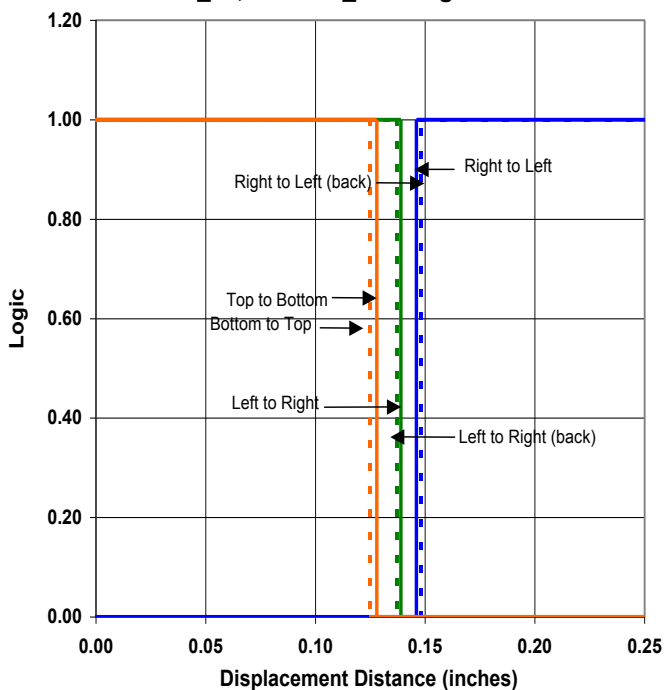

OPB930_55, OPB940_55 - Flag Next to Sensor

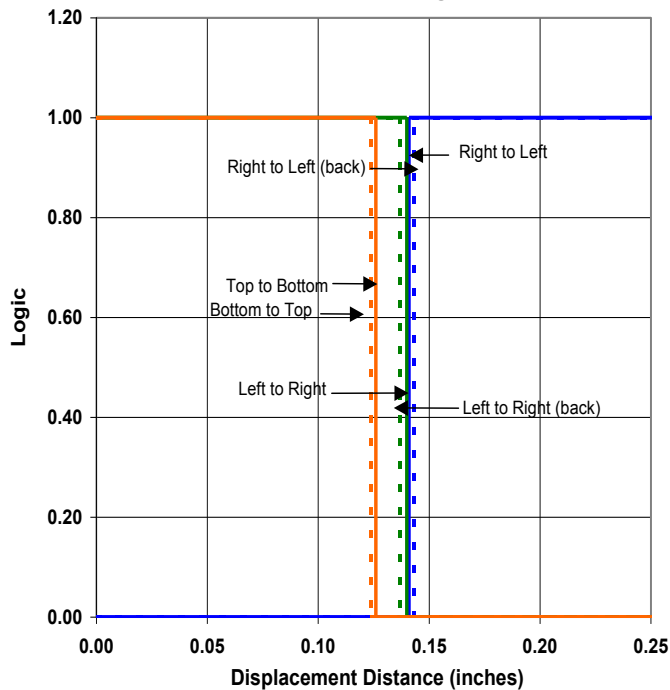

OPB930_55, OPB940_55 - Flag in Middle of Slot

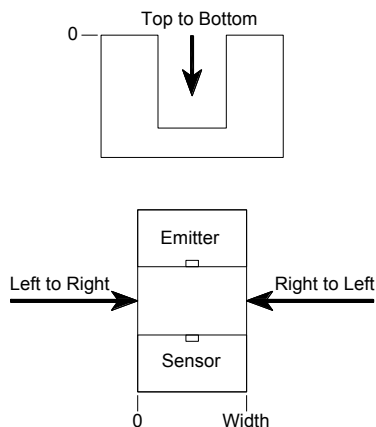
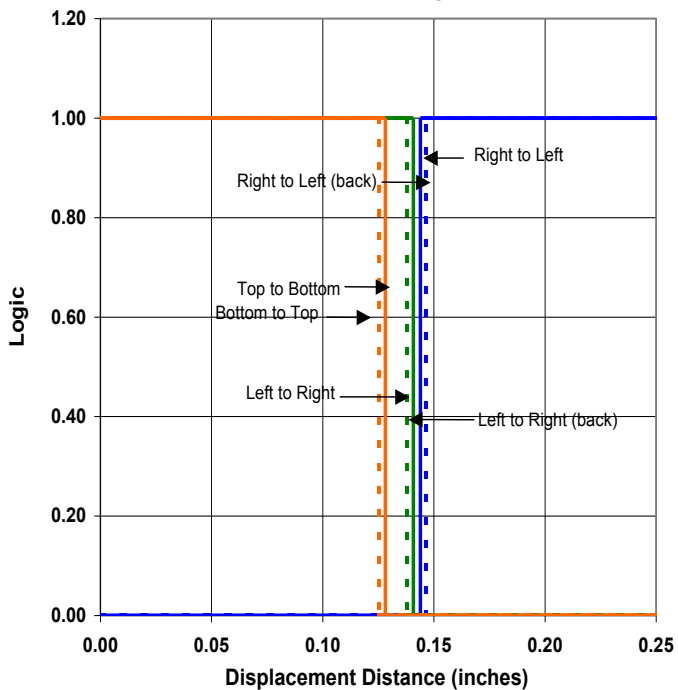

General Note
TT Electronics reserves the right to make changes in product specification without notice or liability. All information is subject to TT Electronics' own data and is considered accurate at time of going to print.

