



Chipsmall Limited consists of a professional team with an average of over 10 year of expertise in the distribution of electronic components. Based in Hongkong, we have already established firm and mutual-benefit business relationships with customers from,Europe,America and south Asia,supplying obsolete and hard-to-find components to meet their specific needs.

With the principle of "Quality Parts,Customers Priority,Honest Operation,and Considerate Service",our business mainly focus on the distribution of electronic components. Line cards we deal with include Microchip,ALPS,ROHM,Xilinx,Pulse,ON,Everlight and Freescale. Main products comprise IC,Modules,Potentiometer,IC Socket,Relay,Connector.Our parts cover such applications as commercial,industrial, and automotives areas.

We are looking forward to setting up business relationship with you and hope to provide you with the best service and solution. Let us make a better world for our industry!



## Contact us

Tel: +86-755-8981 8866 Fax: +86-755-8427 6832

Email & Skype: info@chipsmall.com Web: www.chipsmall.com

Address: A1208, Overseas Decoration Building, #122 Zhenhua RD., Futian, Shenzhen, China



# Fiber Optic Detector

OPF432



## Features:

- High speed, low capacitance
- Popular ST<sup>®</sup> style receptacle
- Pre-tested with fiber to assure performance
- Component pre-mounted and ready to use
- 100MHz operation minimum

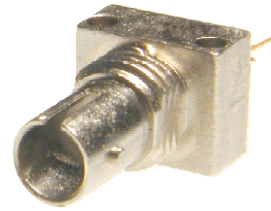

## Description:

The OPF432 is a low noise silicon PIN photodiode mounted in a low cost package for fiber optic applications. It offers fast response at moderate bias and is compatible with LED and laser diode sources in the 800-1000 nm wavelength region. Low capacitance improves signal to noise performance in typical short haul LAN applications.

The OPF432 is designed to be compatible with multimode optical fibers from 50/125 to 200/300 microns.

## Applications:

- Industrial Ethernet equipment
- Copper-to-fiber optic links
- Intra-system fiber optic links
- Video surveillance systems

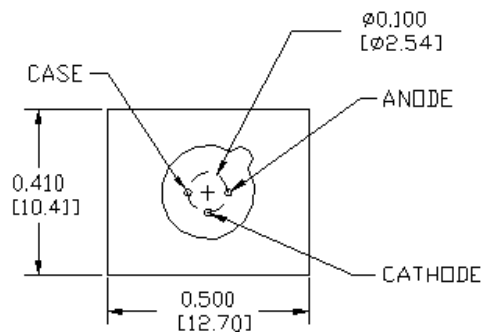
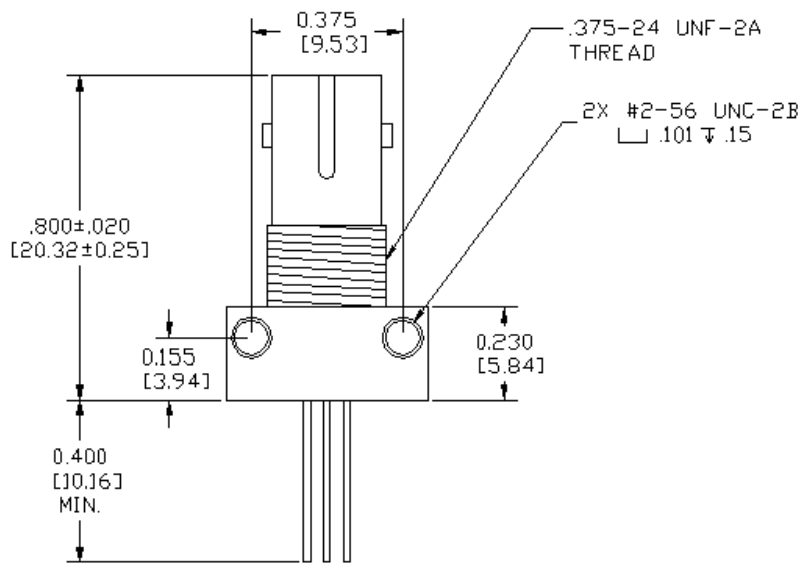

DIMENSIONS ARE IN: [MILLIMETERS]  
[INCHES]



RoHS ST<sup>®</sup> is a registered trademark of AT&T.

General Note  
TT Electronics reserves the right to make changes in product specification without notice or liability. All information is subject to TT Electronics' own data and is considered accurate at time of going to print.

OPTEK Technology, Inc.  
1645 Wallace Drive, Carrollton, TX 75006 | Ph: +1 972 323 2200  
www.optekinc.com | www.ttelectronics.com

### Electrical Specifications

Absolute Maximum Ratings ( $T_A = 25^\circ\text{C}$ unless otherwise noted)	
Storage Temperature Range	-55° C to +125° C
Operating Temperature Range	-40° C to +100° C
Lead Soldering Temperature <sup>(1)</sup>	260° C
Continuous Power Dissipation <sup>(2)</sup>	200 mW
Maximum Reverse Voltage	100 VDC

Electrical Characteristics ( $T_A = 25^\circ\text{C}$ unless otherwise noted)						
SYMBOL	PARAMETER	MIN	TYP	MAX	UNITS	TEST CONDITIONS
R	Responsivity	0.45	0.55		A/W	$V_R = 5.0\text{V}$ ; 50/125 $\mu\text{m}$ fiber; $\lambda = 850\text{nm}$
$I_D$	Dark Current		0.1	5.0	nA	$V_R = 5.0\text{V}$
$\lambda_p$	Peak Response Wavelength		905		nm	
$t_r$	Output Rise Time		2.0		ns	$V_R = 5\text{V}$ ; $R_L = 50\text{W}$ , 10%-90%
$C_T$	Total Capacitance		1.5	2.0	pF	$V_R = 5\text{V}$

**Notes:**

- Maximum of 5 seconds with soldering iron. Duration can be extended to 10 seconds when flow soldering. RMA flux is recommended.
- De-rate linearly at 2.13mW/°C above 25°C .

### Performance

#### Typical Responsivity

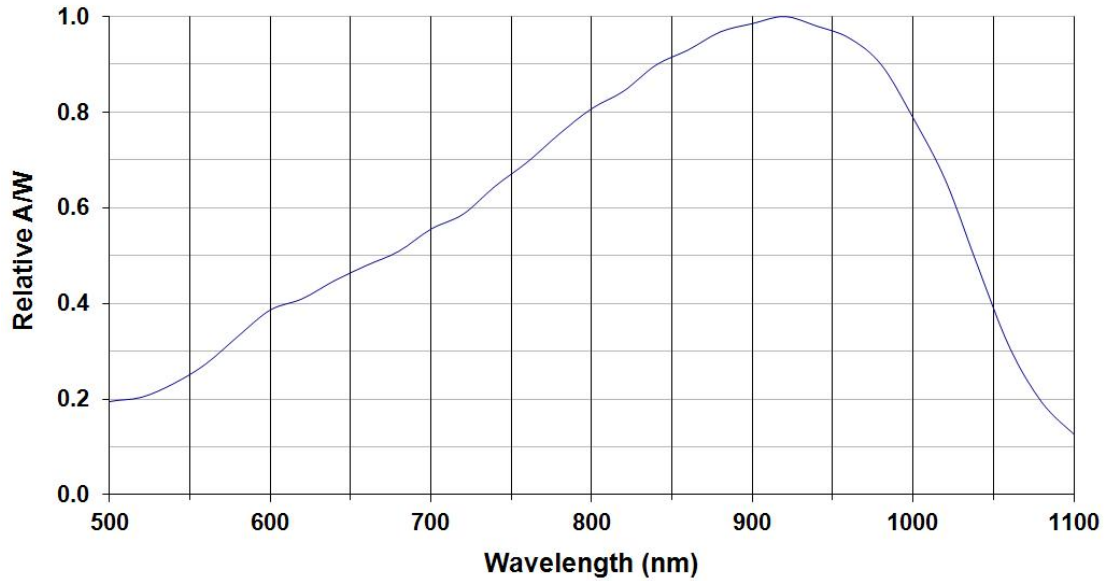

Dark Current vs. Temperature

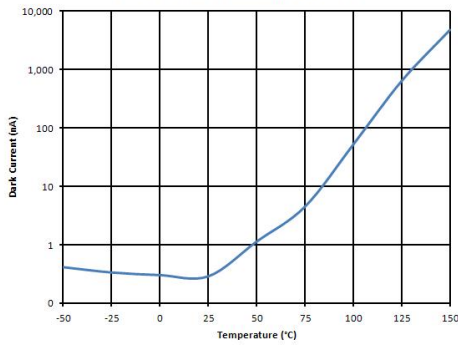

Rise Time vs. Bias Voltage

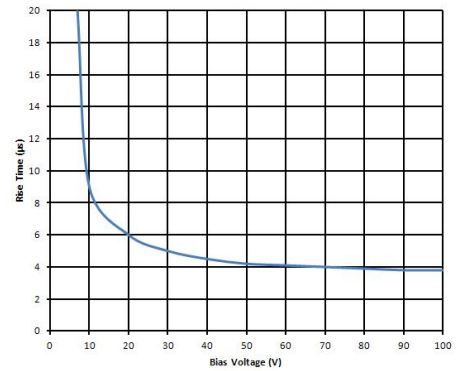

Dark Current vs. Bias Voltage

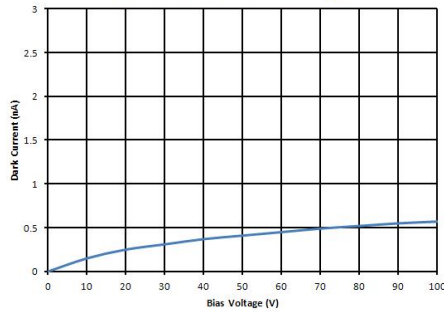

Capacitance vs. Bias Voltage

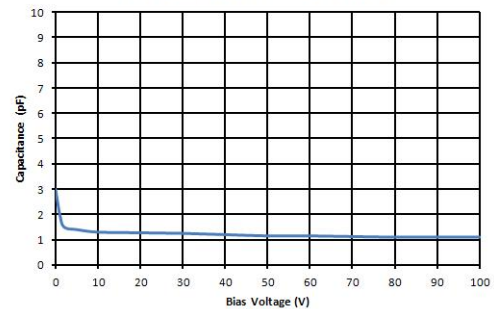

General Note  
 TT Electronics reserves the right to make changes in product specification without notice or liability. All information is subject to TT Electronics' own data and is considered accurate at time of going to print.

OPTEK Technology, Inc.  
 1645 Wallace Drive, Carrollton, TX 75006 | Ph: +1 972 323 2200  
[www.optekinc.com](http://www.optekinc.com) | [www.ttelectronics.com](http://www.ttelectronics.com)