



Chipsmall Limited consists of a professional team with an average of over 10 year of expertise in the distribution of electronic components. Based in Hongkong, we have already established firm and mutual-benefit business relationships with customers from,Europe,America and south Asia,supplying obsolete and hard-to-find components to meet their specific needs.

With the principle of “Quality Parts,Customers Priority,Honest Operation,and Considerate Service”,our business mainly focus on the distribution of electronic components. Line cards we deal with include Microchip,ALPS,ROHM,Xilinx,Pulse,ON,Everlight and Freescale. Main products comprise IC,Modules,Potentiometer,IC Socket,Relay,Connector.Our parts cover such applications as commercial,industrial, and automotives areas.

We are looking forward to setting up business relationship with you and hope to provide you with the best service and solution. Let us make a better world for our industry!



Contact us

Tel: +86-755-8981 8866 Fax: +86-755-8427 6832

Email & Skype: info@chipsmall.com Web: www.chipsmall.com

Address: A1208, Overseas Decoration Building, #122 Zhenhua RD., Futian, Shenzhen, China



P2110B

915 MHz RF Powerharvester[®] Receiver



DESCRIPTION

The Powercast P2110B Powerharvester[®] is an RF energy harvesting device that converts RF to DC. Housed in a compact SMD package, the P2110B receiver provides RF energy harvesting and power management for battery-free, micro-power devices. The P2110B converts RF energy to DC and stores it in a capacitor. When a charge threshold on the capacitor is achieved, the P2110B boosts the voltage to the set output voltage level and enables the voltage output. When the charge on the capacitor declines to the low voltage threshold the voltage output is turned off. A microprocessor can be used to optimize the power usage from the P2110B and obtain other data from the component for improving overall system operation.

FEATURES

- High conversion efficiency
- Converts low-level RF signals enabling long range applications
- Regulated voltage output up to 5.5V
- Up to 50mA output current
- Received signal strength indicator
- No external RF components required – Internally matched to 50 ohms
- Wide RF operating range
- Operation down to -12 dBm input power
- Externally resettable for microprocessor control
- Industrial temperature range
- RoHS compliant

APPLICATIONS

- Battery-free wireless sensors
 - Industrial Monitoring
 - Smart Grid
 - Defense
 - Building automation
 - Oil & Gas
- Battery recharging
 - Coin cells
 - Thin-film cells
- Low power electronics

FUNCTIONAL BLOCK DIAGRAM

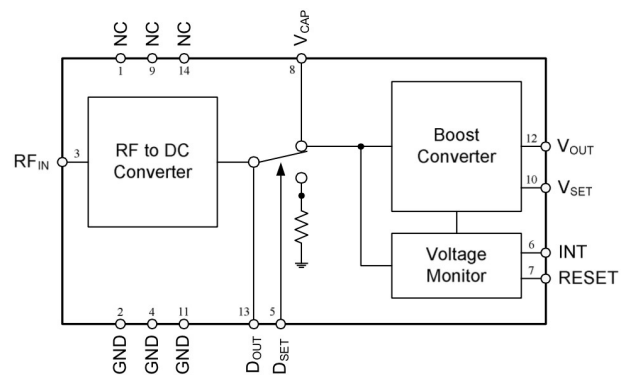

PIN CONFIGURATION TOP VIEW

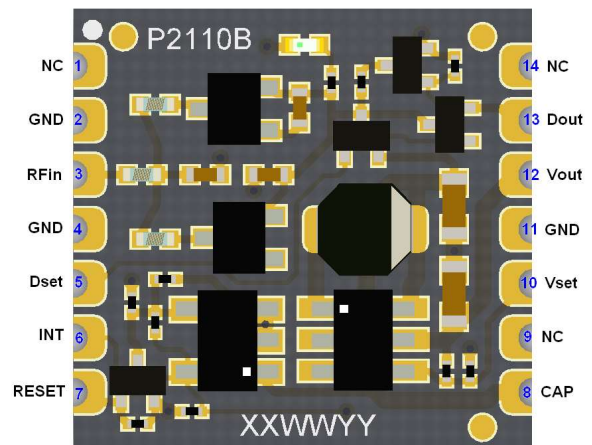

Powercast products and technology are covered by one or more of the following patents and other patents pending:

6,289,237 | 6,615,074 | 6,856,291 | 7,027,311 | 7,057,514 | 7,639,994 | 7,643,312 | 7,812,771 | 7,844,306 | 7,868,482 | 7,898,105 | 7,925,308 | 8,159,090 | 8,380,255 | 8,432,062 | 8,461,817 | 8,621,245

P2110B

915 MHz RF Powerharvester[®] Receiver



ABSOLUTE MAXIMUM RATINGS

T_A = 25°C, unless otherwise noted.

Parameter	Rating	Unit
RF Input Power	23	dBm
RF _{IN} to GND	0	V
D _{SET} to GND	6	V
RESET to GND	6	V
V _{CAP} to GND	2.3	V
V _{OUT} to GND	6	V
V _{OUT} Current	100	mA
Operating Temperature Range	-40 to 85	°C
Storage Temperature Range	-40 to 140	°C

Exceeding the absolute maximum ratings may cause permanent damage to the device.

ESD CAUTION

This is an ESD (electrostatic discharge) sensitive device. Proper ESD precautions should be taken to avoid degradation or damage to the component.



PIN FUNCTIONAL DESCRIPTIONS

Pin	Label	Function
1	NC	No Connection.
2	GND	RF Ground. Connect to analog ground plane.
3	RF _{IN}	RF Input. Connect to 50Ω antenna through a 50Ω transmission line. Add a DC block if antenna is a DC short.
4	GND	RF Ground. Connect to analog ground plane.
5	D _{SET}	Digital Input. Set to enable measurement of harvested power. If this function is not desired leave NC.
6	INT	Digital Output. Indicates that voltage is present at V _{OUT} .
7	RESET	Digital Input. Set to disable V _{OUT} . If this function is not desired leave NC.
8	V _{CAP}	Connect to an external capacitor for energy storage.
9	NC	No Connection.
10	V _{SET}	Output Voltage Adjustment. Sets the output voltage by connecting a resistor to V _{OUT} or GND. Leave NC for 3.3V.
11	GND	DC Ground. Connect to analog ground plane.
12	V _{OUT}	DC Output. Connect to external device. The output is preset to 3.3V but can be adjusted with an external resistor.
13	D _{OUT}	Analog Output. Provides an analog voltage level corresponding to the harvested power.
14	NC	No Connection.

P2110B

915 MHz RF Powerharvester[®] Receiver



SPECIFICATIONS

$T_A = 25^\circ\text{C}$, $R_{F_{IN}} = 915\text{MHz}$ unless otherwise noted.

Parameter	Symbol	Condition	Min	Typ	Max	Unit
RF Characteristics ¹						
Input Power	$R_{F_{IN}}$		-12		10	dBm
Frequency			902		928	MHz
DC Characteristics						
Output Voltage	V_{OUT}		2.0	3.3	5.5	V
Output Current	I_{OUT}				50	mA
V_{CAP} Maximum	V_{MAX}			1.25		V
V_{CAP} Minimum	V_{MIN}			1.02		V
Signal Strength	D_{OUT}	$R_{F_{IN}} = 0\text{dBm}$		275		mV
Boost Efficiency		$I_{OUT} = 20\text{mA}$		85		%
Maximum INT Current				0.1		mA
Digital Characteristics						
RESET Input High				1		V
D_{SET} Input High			1.8			V
INT Output High			V_{MIN}		V_{MAX}	V
Timing Characteristics						
D_{SET} Delay				50		μs
RESET Delay				6.6		μs
RESET Pulse Width			20			ns

¹See typical performance graphs for operation at other frequencies or power levels.

TIMING DIAGRAM

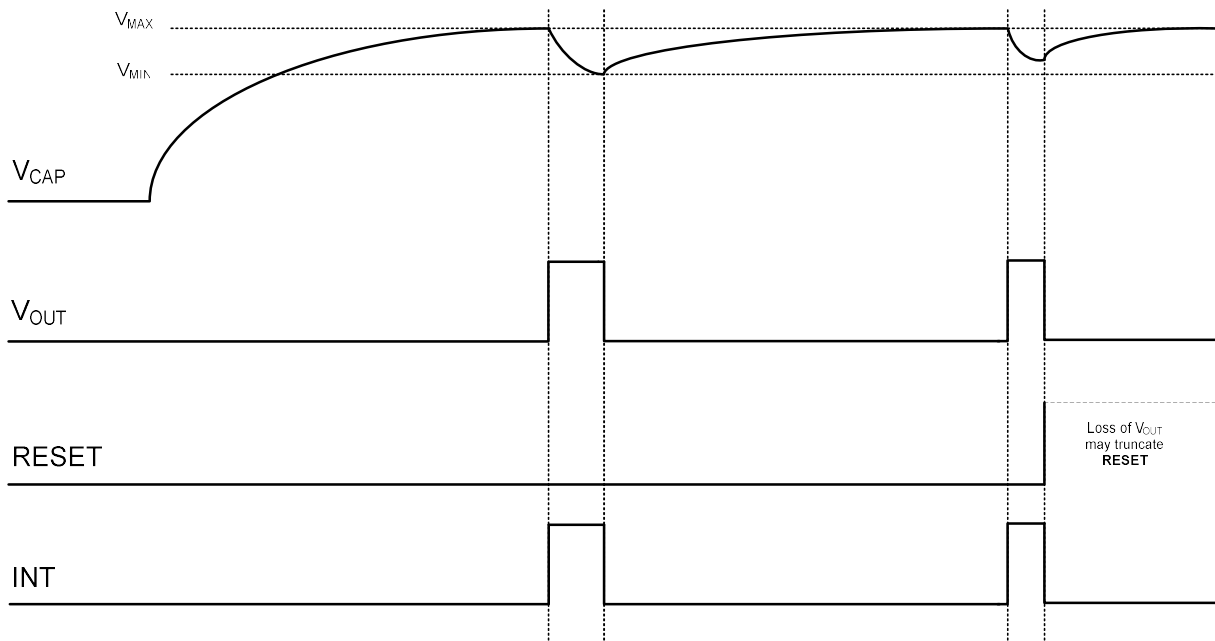

P2110B

915 MHz RF Powerharvester[®] Receiver



FUNCTIONAL DESCRIPTION

RF INPUT (RF_{IN})

The RF input is an unbalanced input from the antenna. Any standard or custom 50Ω antenna may be used with the receiver. The P2110B has been optimized for operation in the 902-928MHz band but will operate outside this band with reduced efficiency. Contact Powercast for custom frequency requirements.

The RF input must be isolated from ground. For antennas that are a DC short, a high-Q DC blocking capacitor should be added in series with the antenna.

STORAGE CAPACITOR SELECTION (V_{CAP})

The P2110B requires an external storage capacitor connected at V_{CAP}. The value of the capacitor will determine the amount of energy available from the V_{OUT} pin. The capacitor should have a leakage current as small as possible. It is recommended that the leakage current of the capacitor be less than 1μA at 1.2V. The capacitor ESR should be 200mΩ or less.

Smaller capacitors will charge more quickly but will result in shorter operation cycles. Larger capacitors will charge more slowly, but will provide for longer operation cycles. The minimum required capacitor value can be estimated using the following equation.

$$C = 15V_{OUT}I_{OUT}t_{ON}$$

Where,

V_{OUT} - Output voltage

I_{OUT} - Average output current

t_{ON} - On-time of the output voltage

When using the RESET function, the size of the capacitor is less important. A larger capacitor can be used to facilitate intermittent functions that require more energy. The RESET will control the amount of energy removed from the capacitor during operation which will minimize the required recharge time. It should be noted that when RESET is used, a larger capacitor will not affect charge time during operation, but it will require more time to initially charge from a completely discharged state.

The voltage on the V_{CAP} pin under normal operation will vary between approximately 1.25V and 1.02V. If the harvested energy becomes too large, the voltage on the capacitor will be internally clamped to protect low voltage supercapacitors. Clamping will begin at approximately 1.8V and will limit the voltage to less than 2.3V at the maximum rated input power.

RSSI OPERATION (D_{OUT}, D_{SET})

The RSSI functionality allows the sampling of the received signal to provide an indication of the amount of energy being harvested. When D_{SET} is driven high the harvested DC power will be directed to an internal sense resistor, and the corresponding voltage will be provided to the D_{OUT} pin. The voltage on the D_{OUT} pin can be read after a 50μs settling time.

When the RSSI functionality is being used, the harvested DC power is not being stored.

P2110B

915 MHz RF Powerharvester[®] Receiver



If the RSSI functionality is not used, D_{OUT} and D_{SET} should be left unconnected. D_{SET} is internally pulled down.

DATA RETRIEVAL (D_{OUT} , D_{SET})

Using D_{OUT} and D_{SET} it is possible to collect data from the RF transmitter that is supplying power to the P2110B. As discussed above, with D_{SET} high, D_{OUT} will provide a voltage across $R3$ that can be read by an ADC. However, the voltage on D_{OUT} will also follow the power level of the RF field as the power level changes. If the RF field is being provided by a transmitter that is also communicating by modulating its amplitude, such as the Powercast TX91501-3W-ID Powercaster[®] transmitter, the data can be read by the P2110B. The voltage level will need gained up using operation amplifiers and supplied to a device that can read the data pattern supplied by the transmitter.

RESET

The RESET function allows the voltage from V_{OUT} to be turned off before the storage capacitor reaches the lower threshold, V_{MIN} , thereby saving energy and improving the recharge time back to the activation threshold, V_{MAX} . The RESET function can be implemented by a microcontroller. When the function of the microcontroller is completed, driving RESET high will disable the voltage from V_{OUT} . Care should be taken to ensure that the microcontroller, especially during power-on, does not inadvertently drive RESET high. This will immediately shutdown the output voltage.

If the RESET functionality is not used, RESET should be left unconnected. RESET is internally pulled down

INTERRUPT (INT)

The interrupt function provides a digital indication that voltage (or current) is present at the V_{OUT} pin. INT can be used in more sophisticated systems that contain other storage elements and can be used as an external interrupt to bring a device such as microcontroller out of a deep sleep mode. The digital high level of the INT pin will be between V_{MIN} and V_{MAX} . The INT pin can provide a maximum of 0.1mA of current.

If the INT functionality is not used, INT should be left unconnected.

SETTING THE OUTPUT VOLTAGE (V_{out})

The DC output voltage from the P2110 is preset to 3.3V. However, it can be adjusted by adding an external resistor to increase or decrease the output voltage using the following equations. ($M = 10^6$)

To **decrease** the output voltage, place a resistor calculated by the following equation from V_{SET} to V_{OUT} . The voltage can be set to a minimum of 2.0V.

$$R = \frac{1M (V_{OUT} - 1.21)}{(3.32 - V_{OUT})}$$

P2110B

915 MHz RF Powerharvester[®] Receiver



To **increase** the output voltage, place a resistor calculated by the following equation from VSET to GND. The voltage can be set to a maximum of 5.5V.

$$R = \frac{1.21M}{(V_{OUT} - 3.32)}$$

LAYOUT CONSIDERATIONS

The RF_{IN} feed line should be designed as a 50Ω trace and should be as short as possible to minimize feed line losses. The following table provides recommended dimensions for 50Ω feed lines (CPWG) for different circuit board configurations.

PCB Side View			
Material	Thickness (H)	Trace Width (S)	Spacing (W)
FR4 (ε _r = 4.2)	62	50	9
FR4 (ε _r = 4.2)	31	50	20

*All dimensions are in mils.

The GND pins on each side of the RF_{IN} pin should be connected to the PCB ground plane through a via located next to the pads under the receiver.

When setting the output voltage, the resistor connected to the VSET pin should be as close as possible to the pin. No external capacitance should be added to this pin.

The D_{OUT} pin can contain low-level analog voltage signals. If a long trace is connected to this pin, additional filtering capacitance next to the A/D converter may be required. Additional capacitance on this pin will increase the D_{SET} delay time.

The trace from VCAP to the storage capacitor should be as short as possible and have a width of greater than 20mils to minimize the series resistance of the trace.

P2110B

915 MHz RF Powerharvester[®] Receiver



TYPICAL PERFORMANCE GRAPHS $T_A = 25^\circ\text{C}$, $V_{\text{OUT}} = 3.3\text{V}$, $V_{\text{CAP}} = 1.2\text{V}$, unless otherwise noted

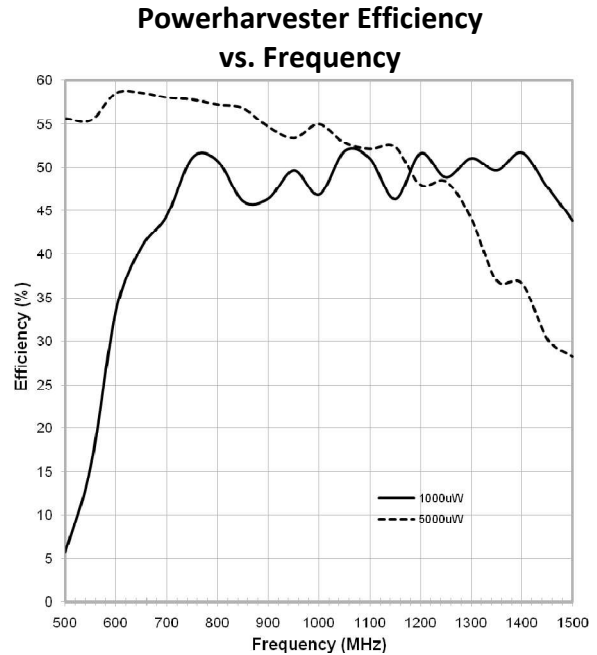
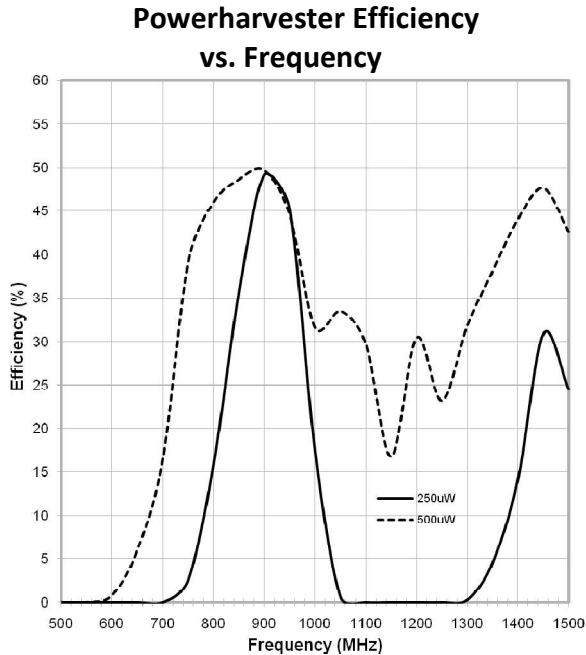
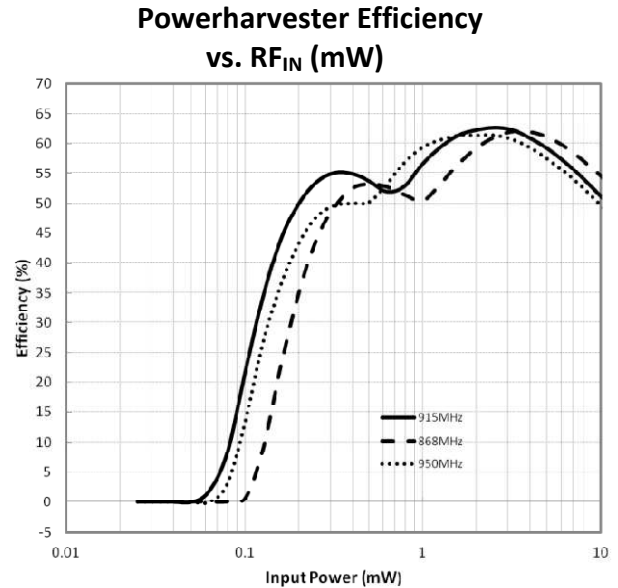
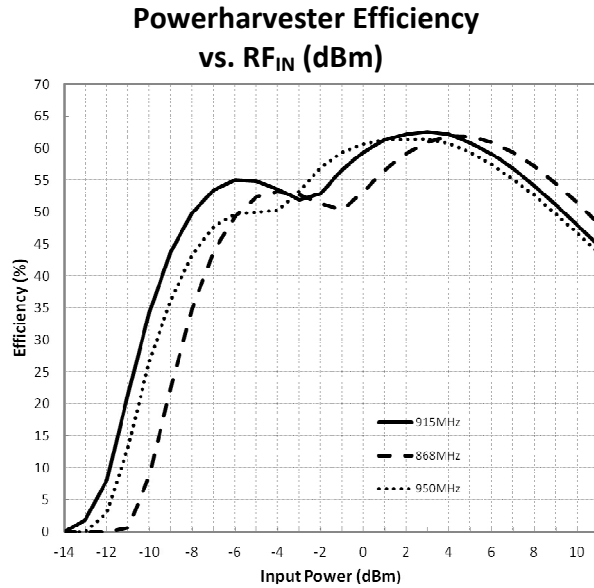

P2110B

915 MHz RF Powerharvester[®] Receiver



TYPICAL PERFORMANCE GRAPHS

$T_A = 25^\circ\text{C}$, $V_{\text{OUT}} = 3.3\text{V}$, $V_{\text{CAP}} = 1.2\text{V}$, unless otherwise noted

Received Signal Strength Indicator vs. RFIN (dBm)

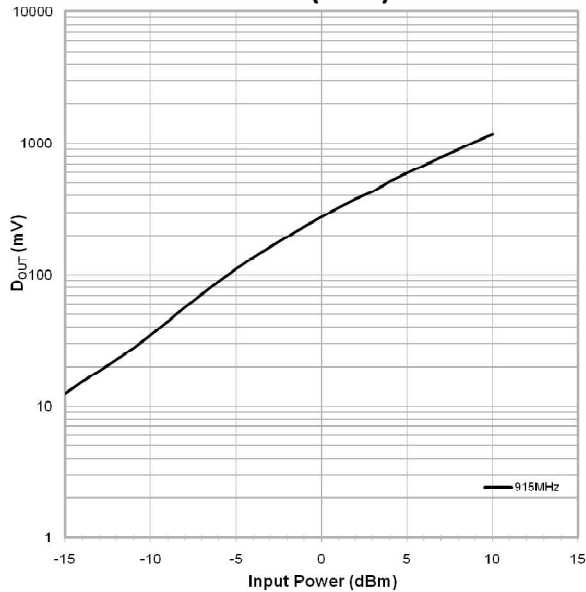

Received Signal Strength Indicator vs. RFIN (mW)

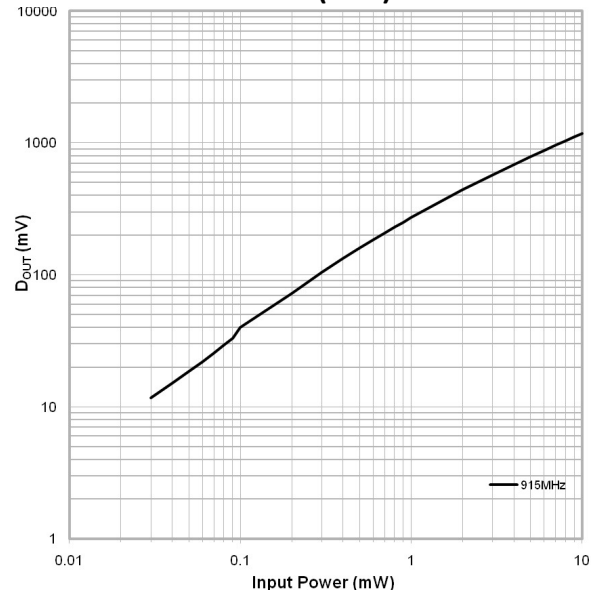

Initial CAP Charge Time to First Activation vs. RFIN (dBm)

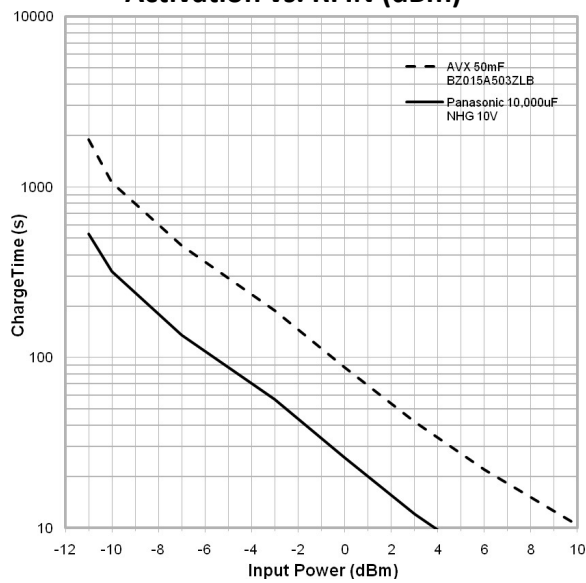

Initial CAP Charge Time to First Activation vs. RFIN (mW)

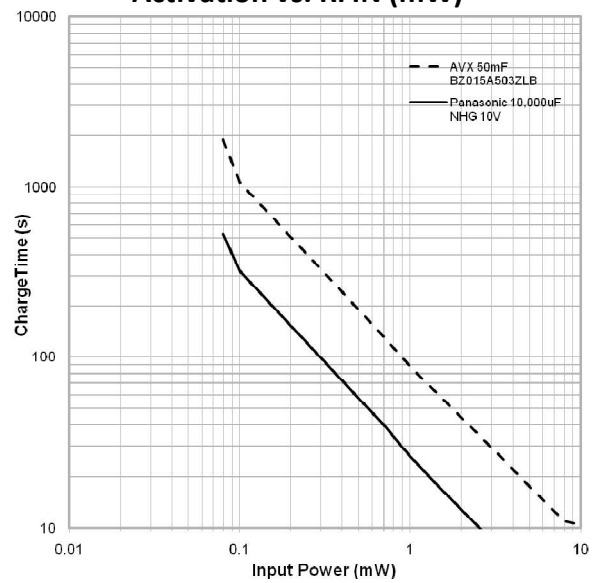

P2110B

915 MHz RF Powerharvester[®] Receiver



Mechanical Specifications

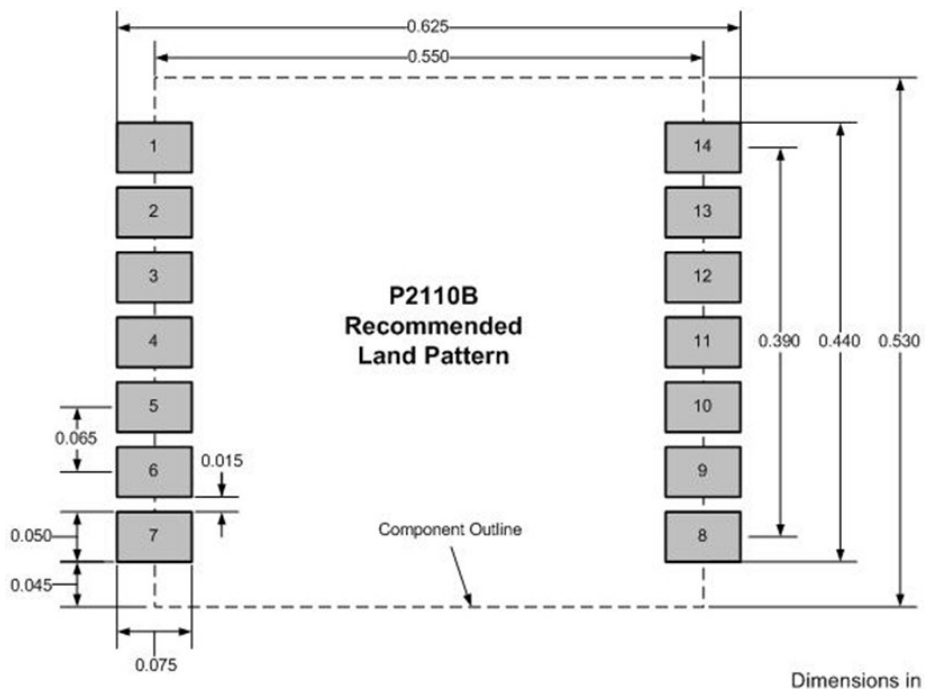
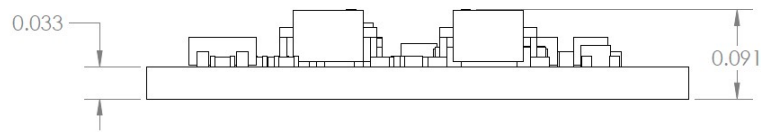
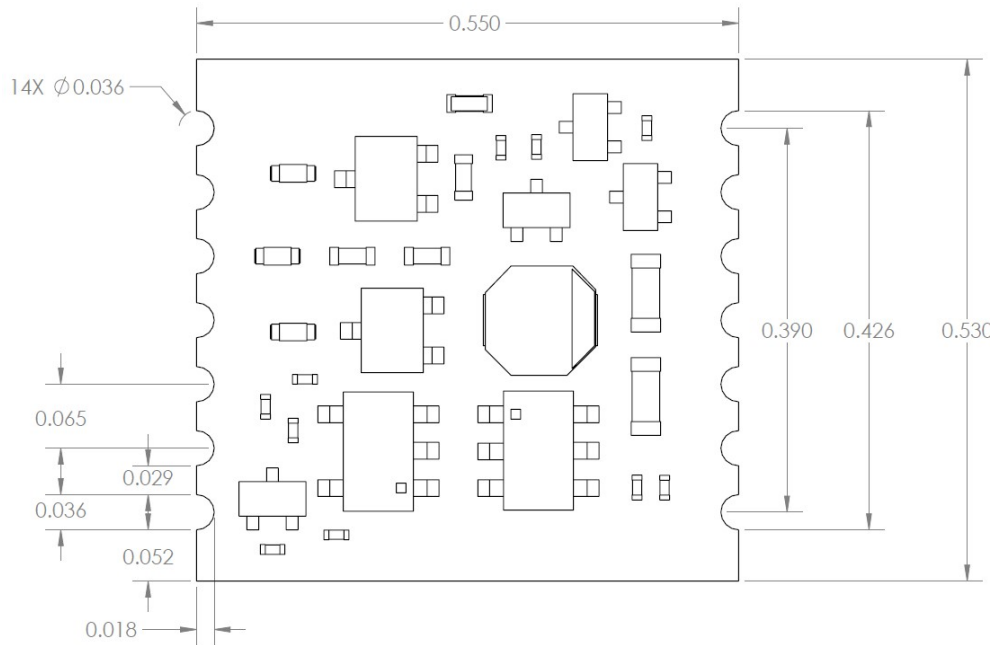

P2110B

915 MHz RF Powerharvester[®] Receiver



P2110 MODULE SERIES

MODULE	STATUS	FUNCTIONAL DIFFERENCES
P2110	End-of-life	N/A
P2110B	Replaced P2110	<ul style="list-style-type: none">• Increased RF-to-DC conversion efficiency• V_{SET} resistor values modified

P2110B

915 MHz RF Powerharvester[®] Receiver



IMPORTANT NOTICE

Information furnished by Powercast Corporation (Powercast) is believed to be accurate and reliable. However, no responsibility is assumed by Powercast for its use, nor for any infringements of patents or other rights of third parties that may result from its use. Specifications are subject to change without notice.

No license is granted by implication or otherwise under any patent or patent rights of Powercast. Trademarks and registered trademarks are the property of their respective owners.

POWERCAST PRODUCTS (INCLUDING HARDWARE AND/OR SOFTWARE) ARE NOT DESIGNED OR INTENDED TO BE FAIL-SAFE, FAULT TOLERANT OR FOR USE IN ANY APPLICATION THAT COULD LEAD TO DEATH, PERSONAL INJURY OR SEVERE PROPERTY OR ENVIRONMENTAL DAMAGE (INDIVIDUALLY AND COLLECTIVELY, "CRITICAL APPLICATIONS"), SUCH AS LIFE-SUPPORT OR SAFETY DEVICES OR SYSTEMS, CLASS III MEDICAL DEVICES, NUCLEAR FACILITIES, APPLICATIONS THAT AFFECT CONTROL OF A VEHICLE OR AIRCRAFT, APPLICATIONS RELATED TO THE DEPLOYMENT OF AIRBAGS, OR ANY OTHER CRITICAL APPLICATIONS. CUSTOMER AGREES, PRIOR TO USING OR DISTRIBUTING ANY SYSTEMS THAT INCORPORATE POWERCAST PRODUCTS, TO THOROUGHLY TEST THE SAME FOR SAFETY PURPOSES. CUSTOMER ASSUMES THE SOLE RISK AND LIABILITY OF ANY USE OF POWERCAST PRODUCTS IN CRITICAL APPLICATIONS, SUBJECT ONLY TO APPLICABLE LAWS AND REGULATIONS GOVERNING LIMITATIONS ON PRODUCT LIABILITY.

Powercast warrants its products in accordance with Powercast's standard warranty available at www.powercastco.com.