



Chipsmall Limited consists of a professional team with an average of over 10 year of expertise in the distribution of electronic components. Based in Hongkong, we have already established firm and mutual-benefit business relationships with customers from,Europe,America and south Asia,supplying obsolete and hard-to-find components to meet their specific needs.

With the principle of “Quality Parts,Customers Priority,Honest Operation,and Considerate Service”,our business mainly focus on the distribution of electronic components. Line cards we deal with include Microchip,ALPS,ROHM,Xilinx,Pulse,ON,Everlight and Freescale. Main products comprise IC,Modules,Potentiometer,IC Socket,Relay,Connector.Our parts cover such applications as commercial,industrial, and automotives areas.

We are looking forward to setting up business relationship with you and hope to provide you with the best service and solution. Let us make a better world for our industry!



## Contact us

Tel: +86-755-8981 8866 Fax: +86-755-8427 6832

Email & Skype: info@chipsmall.com Web: www.chipsmall.com

Address: A1208, Overseas Decoration Building, #122 Zhenhua RD., Futian, Shenzhen, China



**TwinChip™ Series - DO-214**



**Agency Approvals**

Agency	Agency File Number
	E133083

**Pinout Designation**

NOT APPLICABLE

**Schematic Symbol**



**Description**

TwinChip™ Series DO-214 are very low capacitance SIDACtor® thyristors designed to protect broadband equipment such as VoIP, DSL modems and DSLAMs from damaging overvoltage transients. This series provides a surface mount solution that enables equipment to comply with global regulatory standards, while limiting the impact to broadband signals.

**Features and Benefits**

- Low voltage overshoot
- Low on-state voltage
- Does not degrade surge capability after multiple surge events within limit.
- Low distortion
- Fails short circuit when surged in excess of ratings
- 40% lower than comparable product
- RoHS Compliant and Halogen-Free
- Pb-free E3 means 2nd level interconnect is Pb-free and the terminal finish material is tin(Sn) (IPC/JEDEC J-STD-609A.01)

**Applicable Global Standards**

- TIA/968-A/B
- ITU K.20/21/45
- IEC 61000-4-5 2nd edition
- GR 1089 Intra-building
- YD/T 1082
- YD/T 993
- YD/T 950
- ITU K.20/21/45 Enhanced\*
- GR 1089 Inter-building\*

\* Additional series resistance may be required to comply

**Electrical Characteristics**

Part Number	Marking	$V_{DRM}$ @ $I_{DRM}=5\mu A$	$V_s$ @ 100V/ $\mu s$	$I_H$	$I_s$	$I_T$	$V_T$ @ $I_T=2.2$ Amps	@ 1MHz, 2V bias	
		V min	V max	mA min	mA max	A max	V max	pF min	pF max
P0642SALRP	P062A	58	77	120	800	2.2	8	25	45
P0722SALRP	P072A	65	88	120	800	2.2	8	20	45
P0902SALRP	P092A	75	98	120	800	2.2	8	20	40
P1102SALRP	P112A	90	130	120	800	2.2	8	15	35
P1302SALRP	P132A	120	160	120	800	2.2	8	15	35
P1502SALRP	P152A	140	180	120	800	2.2	8	15	30
P1802SALRP	P182A	170	220	120	800	2.2	8	10	30
P2302SALRP	P232A	190	260	120	800	2.2	8	10	25
P2602SALRP	P262A	220	300	120	800	2.2	8	10	25
P3002SALRP	P302A	280	360	120	800	2.2	8	10	25
P3502SALRP	P352A	320	400	120	800	2.2	8	10	20
P4202SALRP	P422A	380	500	120	800	2.2	8	10	20
P4802SALRP	P482A	440	600	120	800	2.2	8	5	20
P6002SALRP	P602A	550	700	120	800	2.2	8	5	20

Table continues on next page.

### Electrical Characteristics (continued)

Part Number	Marking	$V_{DRM}$ @ $I_{DRM}=5\mu A$	$V_S$ @ 100V/ $\mu s$	$I_H$	$I_S$	$I_T$	$V_T$ @ $I_T=2.2 A$	@ 1MHz, 2V bias	
		V min	V max	mA min	mA max	A max	V max	pF min	pF max
P0642SBLRP	P062B	58	77	120	800	2.2	8	25	45
P0722SBLRP	P072B	65	88	120	800	2.2	8	20	45
P0902SBLRP	P092B	75	98	120	800	2.2	8	20	40
P1102SBLRP	P112B	90	130	120	800	2.2	8	15	35
P1302SBLRP	P132B	120	160	120	800	2.2	8	15	35
P1502SBLRP	P152B	140	180	120	800	2.2	8	15	30
P1802SBLRP	P182B	170	220	120	800	2.2	8	10	30
P2302SBLRP	P232B	190	260	120	800	2.2	8	10	25
P2602SBLRP	P262B	220	300	120	800	2.2	8	10	25
P3002SBLRP	P302B	280	360	120	800	2.2	8	10	25
P3502SBLRP	P352B	320	400	120	800	2.2	8	10	20
P4202SBLRP	P422B	380	500	120	800	2.2	8	10	20
P4802SBLRP	P482B	440	600	120	800	2.2	8	5	20
P6002SBLRP	P602B	550	700	120	800	2.2	8	5	20
P3002SCLRP	P302C	280	360	120	800	2.2	8	20	35
P3502SCLRP	P352C	320	400	120	800	2.2	8	20	30
P4202SCLRP	P422C	380	500	120	800	2.2	8	15	30
P4802SCLRP	P482C	440	600	120	800	2.2	8	15	30
P6002SCLRP	P602C	550	700	120	800	2.2	8	10	25
P7002SCLRP*	P702C	640	850	120	800	2.2	8	10	30

- Notes:
- Absolute maximum ratings measured at  $T_A=25^\circ C$  (unless otherwise noted).
  - Components are bi-directional.
  - Part with \* is under development

### Surge Ratings

Series	$I_{PP}$									$I_{TSM}$ 50/60 Hz	di/dt A/ $\mu s$
	0.2/310 <sup>1</sup> 0.5/700 <sup>2</sup>	2/10 <sup>1</sup> 2/10 <sup>2</sup>	8/20 <sup>1</sup> 1.2/50 <sup>2</sup>	10/160 <sup>1</sup> 10/160 <sup>2</sup>	10/560 <sup>1</sup> 10/560 <sup>2</sup>	5/320 <sup>1</sup> 9/720 <sup>2</sup>	10/360 <sup>1</sup> 10/360 <sup>2</sup>	10/1000 <sup>1</sup> 10/1000 <sup>2</sup>	5/310 <sup>1</sup> 10/700 <sup>2</sup>		
	A min	A min	A min	A min	A min	A min	A min	A min	A min		
A	20	150	150	90	50	75	75	45	75	20	500
B	25	250	250	150	100	100	125	80	100	25	500
C	50	500	400	200	150	200	175	100	200	30	500

- Notes:
- 1 Current waveform in  $\mu s$   
2 Voltage waveform in  $\mu s$
- Peak pulse current rating ( $I_{pp}$ ) is repetitive and guaranteed for the life of the product that remains in thermal equilibrium.
  - $I_{pp}$  ratings applicable over temperature range of  $-40^\circ C$  to  $+85^\circ C$
  - The component must initially be in thermal equilibrium with  $-40^\circ C \leq T_j \leq +150^\circ C$

### Additional Information



Datasheet



Resources



Samples

**Thermal Considerations**

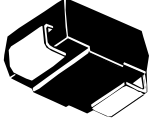
Package	Symbol	Parameter	Value	Unit
DO-214AA 	$T_J$	Operating Junction Temperature Range	-40 to +150	°C
	$T_S$	Storage Temperature Range	-65 to +150	°C
	$R_{\theta JA}$	Thermal Resistance: Junction to Ambient	90	°C/W

**V-I Characteristics**

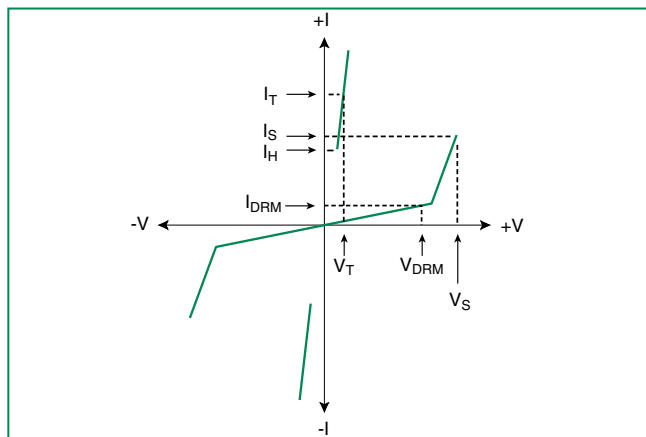

**$t_r \times t_d$  Pulse Waveform**

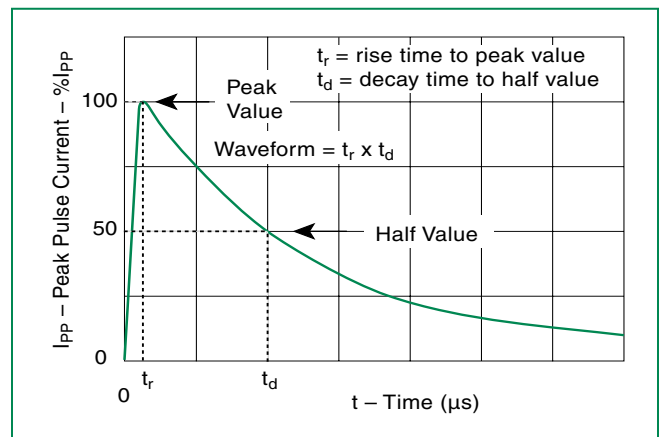

**Normalized  $V_S$  Change vs. Junction Temperature**

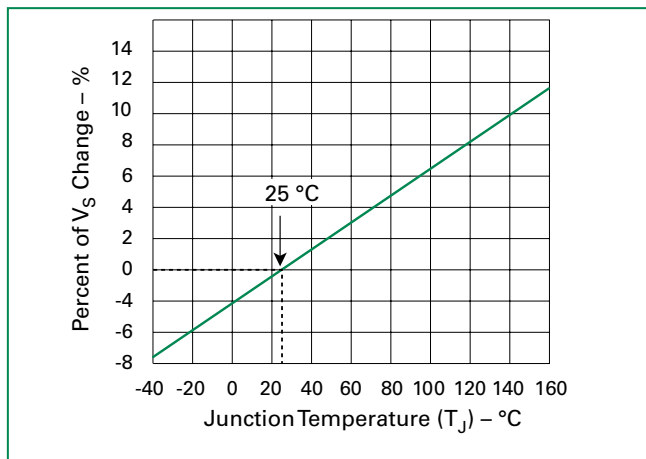

**Normalized DC Holding Current vs. Case Temperature**

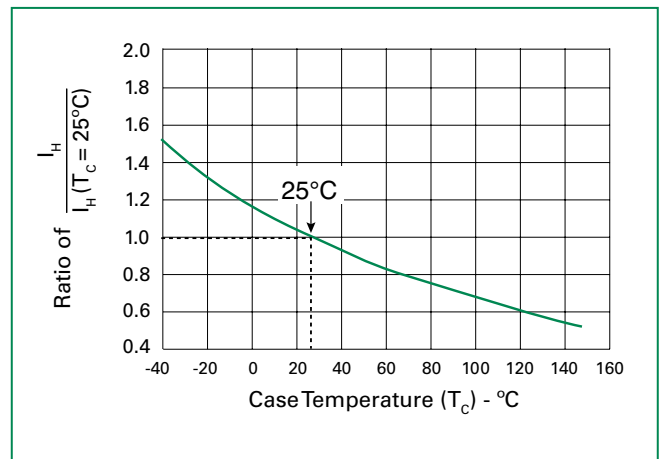

**Soldering Parameters**

Reflow Condition		Pb-Free assembly (see Fig. 1)
Pre Heat	-Temperature Min ( $T_{s(min)}$ )	+150°C
	-Temperature Max ( $T_{s(max)}$ )	+200°C
	-Time (Min to Max) ( $t_s$ )	60-180 secs.
Average ramp up rate (Liquidus Temp ( $T_L$ ) to peak)		3°C/sec. Max.
$T_{s(max)}$ to $T_L$ - Ramp-up Rate		3°C/sec. Max.
Reflow	-Temperature ( $T_L$ ) (Liquidus)	+217°C
	-Temperature ( $t_L$ )	60-150 secs.
Peak Temp ( $T_p$ )		+260(+0/-5)°C
Time within 5°C of actual Peak Temp ( $t_p$ )		30 secs. Max.
Ramp-down Rate		6°C/sec. Max.
Time 25°C to Peak Temp ( $T_p$ )		8 min. Max.
Do not exceed		+260°C

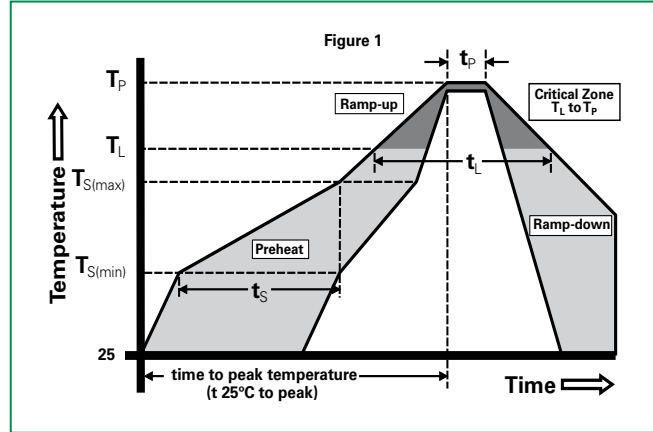

**Physical Specifications**

<b>Lead Material</b>	Copper Alloy
<b>Terminal Finish</b>	100% Matte-Tin Plated
<b>Body Material</b>	UL Recognized epoxy meeting flammability classification V-0

**Part Marking**

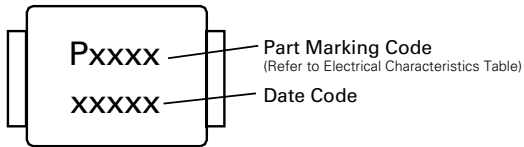

**Environmental Specifications**

<b>High Temp Voltage Blocking</b>	80% Rated $V_{DRM}$ ( $V_{AC Peak}$ ) +125°C or +150°C, 504 or 1008 hrs. MIL-STD-750 (Method 1040) JEDEC, JESD22-A-101
<b>Temp Cycling</b>	-65°C to +150°C, 15 min. dwell, 10 up to 100 cycles. MIL-STD-750 (Method 1051) EIA/JEDEC, JESD22-A104
<b>Biased Temp &amp; Humidity</b>	52 $V_{DC}$ (+85°C) 85%RH, 504 up to 1008 hrs. EIA/JEDEC, JESD22-A-101
<b>High Temp Storage</b>	+150°C 1008 hrs. MIL-STD-750 (Method 1031) JEDEC, JESD22-A-101
<b>Low Temp Storage</b>	-65°C, 1008 hrs.
<b>Thermal Shock</b>	0°C to +100°C, 5 min. dwell, 10 sec. transfer, 10 cycles. MIL-STD-750 (Method 1056) JEDEC, JESD22-A-106
<b>Autoclave (Pressure Cooker Test)</b>	+121°C, 100%RH, 2atm, 24 up to 168 hrs. EIA/JEDEC, JESD22-A-102
<b>Resistance to Solder Heat</b>	+260°C, 30 secs. MIL-STD-750 (Method 2031)
<b>Moisture Sensitivity Level</b>	85%RH, +85°C, 168 hrs., 3 reflow cycles (+260°C Peak). JEDEC-J-STD-020, Level 1

**Dimensions — DO-214AA**

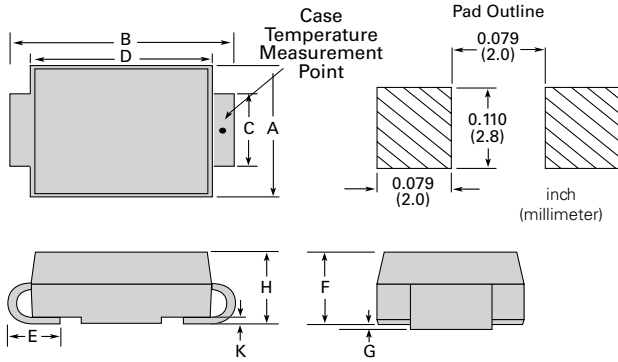

Dimensions	Inches		Millimeters	
	Min	Max	Min	Max
<b>A</b>	0.130	0.156	3.30	3.95
<b>B</b>	0.201	0.220	5.10	5.60
<b>C</b>	0.077	0.087	1.95	2.20
<b>D</b>	0.159	0.181	4.05	4.60
<b>E</b>	0.030	0.063	0.75	1.60
<b>F</b>	0.075	0.096	1.90	2.45
<b>G</b>	0.002	0.008	0.05	0.20
<b>H</b>	0.077	0.104	1.95	2.65
<b>K</b>	0.006	0.016	0.15	0.41

**Part Numbering**

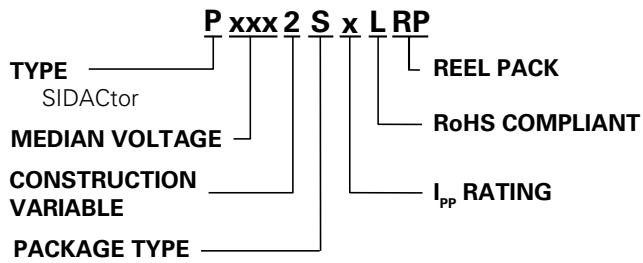

**Packing Options**

Package Type	Description	Quantity	Added Suffix	Industry Standard
S	DO-214AA Tape & Reel	2500	RP	EIA-481-D

**Tape and Reel Specification — DO-214AA**

