



Chipsmall Limited consists of a professional team with an average of over 10 year of expertise in the distribution of electronic components. Based in Hongkong, we have already established firm and mutual-benefit business relationships with customers from,Europe,America and south Asia,supplying obsolete and hard-to-find components to meet their specific needs.

With the principle of “Quality Parts,Customers Priority,Honest Operation,and Considerate Service”,our business mainly focus on the distribution of electronic components. Line cards we deal with include Microchip,ALPS,ROHM,Xilinx,Pulse,ON,Everlight and Freescale. Main products comprise IC,Modules,Potentiometer,IC Socket,Relay,Connector.Our parts cover such applications as commercial,industrial, and automotives areas.

We are looking forward to setting up business relationship with you and hope to provide you with the best service and solution. Let us make a better world for our industry!



Contact us

Tel: +86-755-8981 8866 Fax: +86-755-8427 6832

Email & Skype: info@chipsmall.com Web: www.chipsmall.com

Address: A1208, Overseas Decoration Building, #122 Zhenhua RD., Futian, Shenzhen, China





ASM2P2304NZ

Four Output PCI-X and General Purpose Buffer

Features

- One input to four Output Buffer/Driver
- General-purpose or PCI-X clock buffer
- Buffers all frequencies from DC to 140MHz
- Output-to-output skew less than 100pS
- Available in 8-pin TSSOP and SOIC Packages
- 3.3V operation

Functional Description

The ASM2P2304NZ is a low-cost buffer designed to distribute high-speed clocks for PCI-X and other applications. The device operates at 3.3V and outputs can run up to 140MHz.

Table 1. Function Table.

Inputs		Outputs
BUF_IN	OE	Output [1:4]
L	L	L
H	L	L
L	H	L
H	H	H

Block Diagram

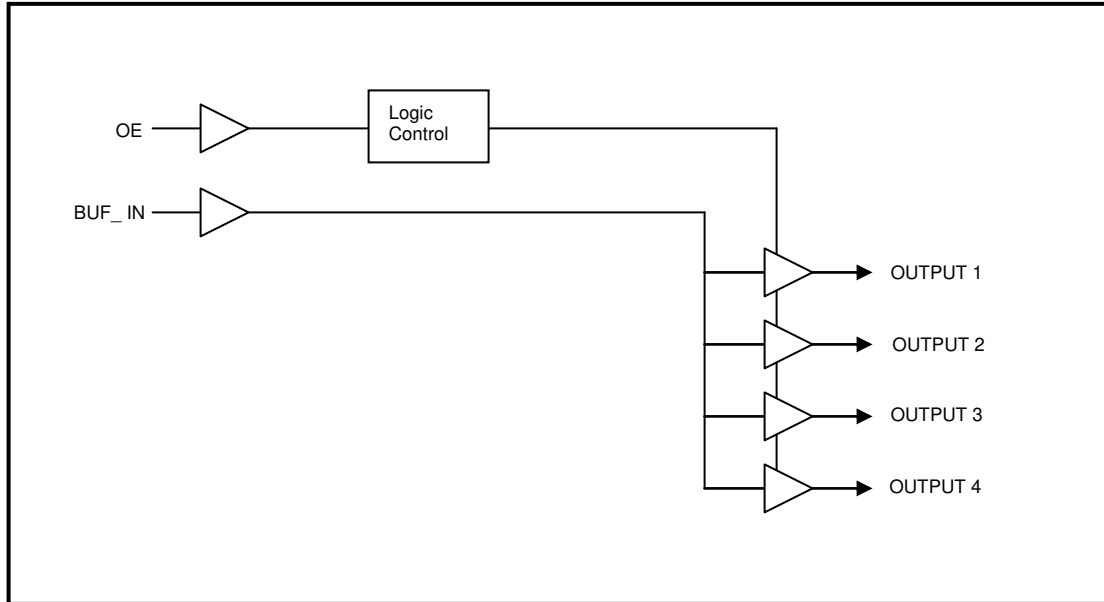

Pin Configuration

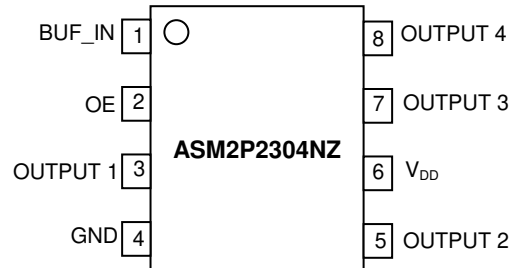

Pin Description

Pin #	Pin Name	Type	Description
1	BUF_IN ¹	I	Input clock. 5V Tolerant Input.
2	OE	I	Input pin for Output Enable, active HIGH. Connect to V _{DD} .
3	Output 1 ²	O	Output 1.
4	GND	P	Ground.
5	Output 2 ²	O	Output 2.
6	V _{DD}	P	3.3V Voltage Supply.
7	Output 3 ²	O	Output 3.
8	Output 4 ²	O	Output 4.

Notes: 1. Weak pull down on input.
2. Weak pull down on all outputs.

Absolute Maximum Ratings

Parameter	Description	Min	Max
Supply Voltage to Ground Potential	-0.5	7	V
DC Input Voltage (Except BUF_IN)	-0.5	$V_{DD} + 0.5$	V
DC Input Voltage (BUF_IN)	-0.5	7	V
Storage Temperature	-65	+150	°C
Max. Soldering Temperature (10 sec)		260	°C
Junction Temperature		150	°C
Static Discharge Voltage (As per JEDEC STD22- A114-B)		2000	V

Note: These are stress ratings only and functional usage is not implied. Exposure to absolute maximum ratings for prolonged periods can affect device reliability.

Operating Conditions

Parameter	Description	Min	Max	Unit
V_{DD}	Supply Voltage	3.0	3.6	V
T_A	Operating Temperature (Ambient Temperature)	-40	85	°C
C_L	Load Capacitance		25	pF
C_{IN}	Input Capacitance		7	pF
BUF_IN, OUTPUT [1:4]	Operating Frequency	DC	140	MHz
t_{PU}	Power-up time for all V_{DD} 's to reach minimum specified Voltage (Power ramps must be monotonic)	0.05	50	mS

Electrical Characteristics

Parameter	Description	Test Conditions	Min	Max	Unit
V _{IL}	Input LOW Voltage ¹			0.8	V
V _{IH}	Input HIGH Voltage ¹		2.0		V
I _{IL}	Input LOW Current	V _{IN} = 0V	-5	5	μA
I _{IH}	Input HIGH Current	V _{IN} = V _{DD}	-5	12	μA
V _{OL}	Output LOW Voltage ²	I _{OL} = 24mA		0.8	V
		I _{OL} = 12mA		0.55	V
V _{OH}	Output HIGH Voltage ²	I _{OH} = -24mA	2.0		V
		I _{OH} = -12mA	2.4		V
I _{DD}	Supply Current	Unloaded outputs at 66.66MHz		25	mA

Notes: 1. BUF_IN input has a threshold voltage of V_{DD}/2.
 2. Parameter is guaranteed by design and characterization. It is not 100% tested in production.

Switching Characteristics for Commercial and Industrial Temperature Devices³

Parameter	Name	Description	Min	Typ	Max	Unit
t _D	Duty Cycle ² = t ₂ ÷ t ₁	Measured at 1.5V	40.0	50.0	60.0	%
t ₃	Rise Time ²	Measured between 0.8V and 2.0V			1.50	nS
t ₄	Fall Time ²	Measured between 2.0V and 0.8V			1.50	nS
t ₅	Output to Output Skew ²	All outputs equally loaded	For Commercial parts		100	pS
			For Industrial parts		150	
t ₆	Propagation Delay, BUF_IN Rising Edge to OUTPUT Rising Edge ²	Measured at V _{DD} /2	2.5	3.5	5	nS

Notes: 1. BUF_IN input has a threshold voltage of V_{DD}/2.
 2. Parameter is guaranteed by design and characterization. It is not 100% tested in production.
 3. All parameters specified with loaded outputs.

Switching Waveforms

Duty Cycle Timing

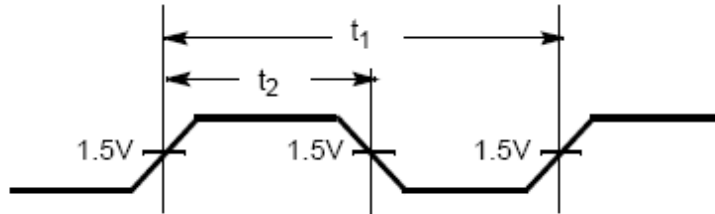

All Outputs Rise/Fall Time

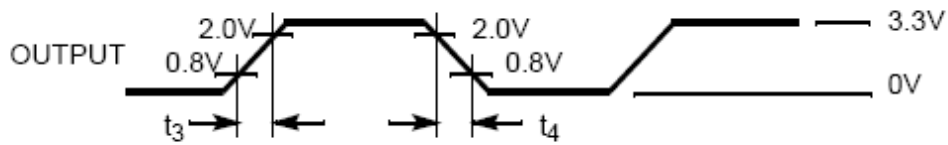

Output-Output Skew

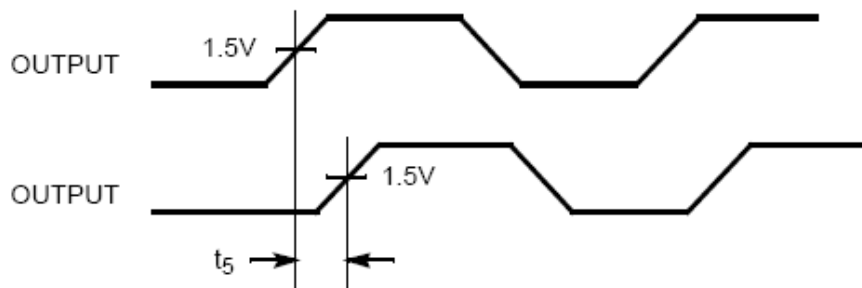

Input-Output Propagation Delay

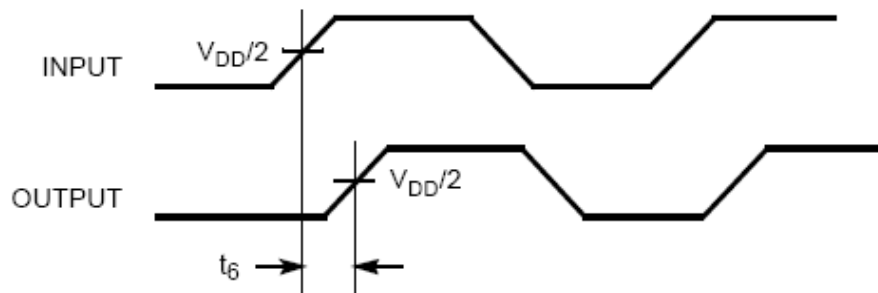

Package Information

8-lead Thin Shrunken Small Outline Package (4.40-MM Body)

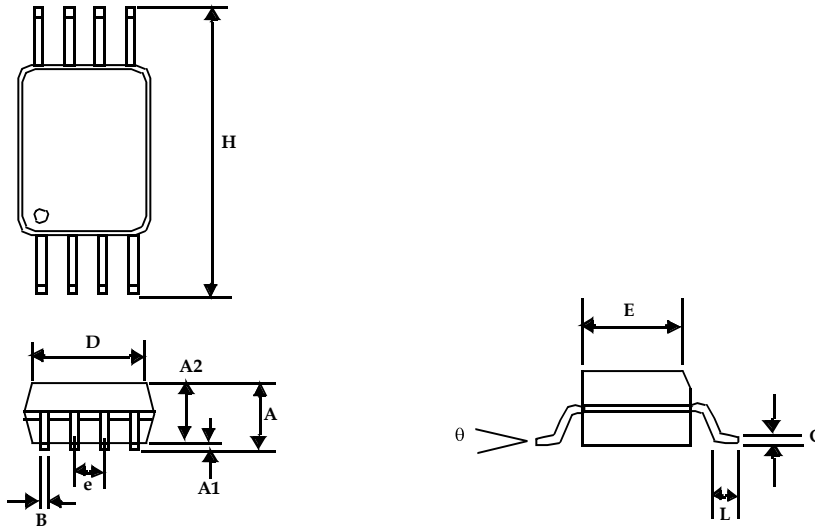

Symbol	Dimensions			
	Inches		Millimeters	
	Min	Max	Min	Max
A		0.043		1.10
A1	0.002	0.006	0.05	0.15
A2	0.033	0.037	0.85	0.95
B	0.008	0.012	0.19	0.30
c	0.004	0.008	0.09	0.20
D	0.114	0.122	2.90	3.10
E	0.169	0.177	4.30	4.50
e	0.026 BSC		0.65 BSC	
H	0.252 BSC		6.40 BSC	
L	0.020	0.028	0.50	0.70
θ	0°	8°	0°	8°

Package Information

8-lead (150-mil) SOIC Package

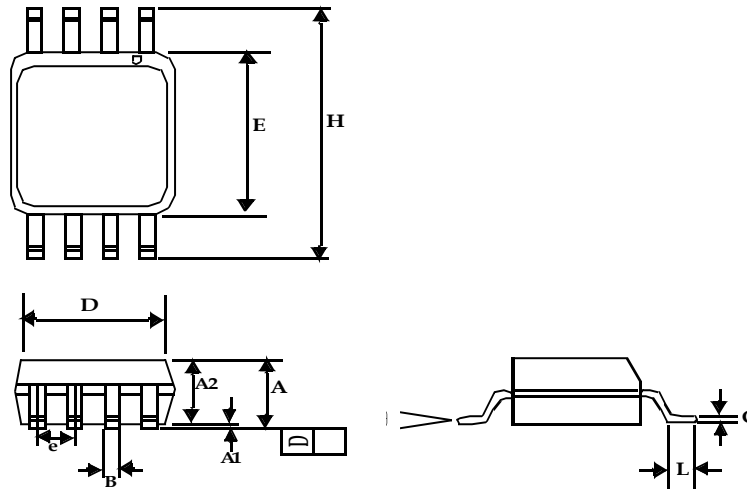

Symbol	Dimensions			
	Inches		Millimeters	
	Min	Max	Min	Max
A1	0.004	0.010	0.10	0.25
A	0.053	0.069	1.35	1.75
A2	0.049	0.059	1.25	1.50
B	0.012	0.020	0.31	0.51
C	0.007	0.010	0.18	0.25
D	0.193 BSC		4.90 BSC	
E	0.154 BSC		3.91 BSC	
e	0.050 BSC		1.27 BSC	
H	0.236 BSC		6.00 BSC	
L	0.016	0.050	0.41	1.27
θ	0°	8°	0°	8°

ASM2P2304NZ

Ordering Code

Part Number	Marking	Package Type	Temperature
P2P2304NZF-08ST	2P2304NZF	8-pin SOIC - Tube, Pb Free	Commercial
P2P2304NZF-08SR	2P2304NZF	8-pin SOIC - Tape and Reel, Pb Free	Commercial
ASM2I2304NZF-08-ST	2I2304NZF	8-pin SOIC - Tube, Pb Free	Industrial
ASM2I2304NZF-08-SR	2I2304NZF	8-pin SOIC - Tape and Reel, Pb Free	Industrial
ASM2P2304NZF-08-TT	2P2304NZF	8-pin TSSOP - Tube, Pb Free	Commercial
P2P2304NZF-08TR	2P2304NZF	8-pin TSSOP - Tape and Reel, Pb Free	Commercial
P2I2304NZF-08TT	2I2304NZF	8-pin TSSOP - Tube, Pb Free	Industrial
P2I2304NZF-08-TR	2I2304NZF	8-pin TSSOP - Tape and Reel, Pb Free	Industrial

Device Ordering Information

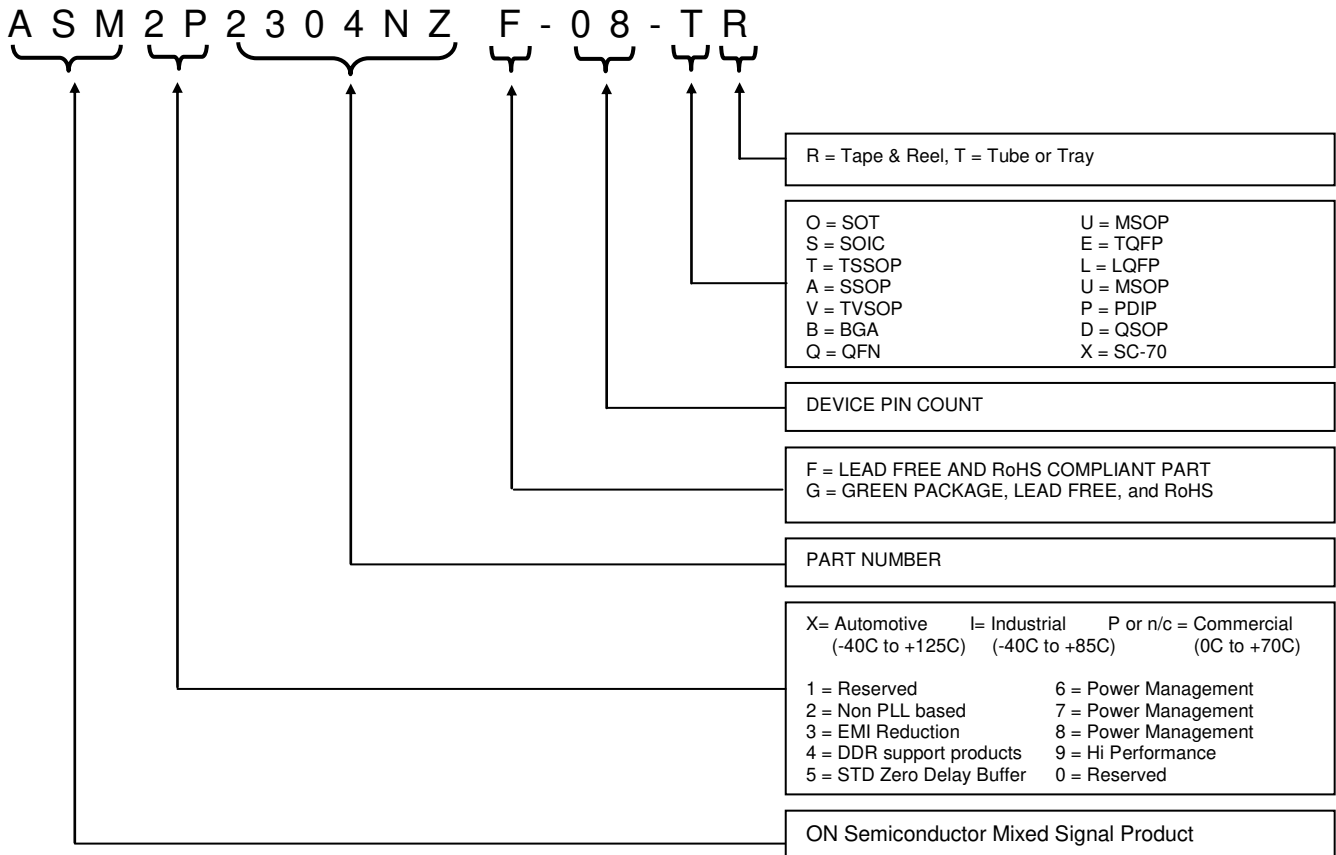

Licensed under US patent #5,488,627, #6,646,463 and #5,631,920.

Note: This product utilizes US Patent #6,646,463 Impedance Emulator Patent issued to PulseCore Semiconductor, dated 11-11-2003.

ON Semiconductor and  are registered trademarks of Semiconductor Components Industries, LLC (SCILLC). SCILLC reserves the right to make changes without further notice to any products herein. SCILLC makes no warranty, representation or guarantee regarding the suitability of its products for any particular purpose, nor does SCILLC assume any liability arising out of the application or use of any product or circuit, and specifically disclaims any and all liability, including without limitation special, consequential or incidental damages. "Typical" parameters which may be provided in SCILLC data sheets and/or specifications can and do vary in different applications and actual performance may vary over time. All operating parameters, including "Typicals" must be validated for each customer application by customer's technical experts. SCILLC does not convey any license under its patent rights nor the rights of others. SCILLC products are not designed, intended, or authorized for use as components in systems intended for surgical implant into the body, or other applications intended to support or sustain life, or for any other application in which the failure of the SCILLC product could create a situation where personal injury or death may occur. Should Buyer purchase or use SCILLC products for any such unintended or unauthorized application, Buyer shall indemnify and hold SCILLC and its officers, employees, subsidiaries, affiliates, and distributors harmless against all claims, costs, damages, and expenses, and reasonable attorney fees arising out of, directly or indirectly, any claim of personal injury or death associated with such unintended or unauthorized use, even if such claim alleges that SCILLC was negligent regarding the design or manufacture of the part. SCILLC is an Equal Opportunity/Affirmative Action Employer. U.S Patent Pending; Timing-Safe and Active Bead are trademarks of PulseCore Semiconductor, a wholly owned subsidiary of ON Semiconductor. This literature is subject to all applicable copyright laws and is not for resale in any manner.

PUBLICATION ORDERING INFORMATION

LITERATURE FULFILLMENT:

Literature Distribution Center for ON Semiconductor
P.O. Box 5163, Denver, Colorado 80217 USA
Phone: 303-675-2175 or 800-344-3860 Toll Free
USA/Canada
Fax: 303-675-2176 or 800-344-3867 Toll Free
USA/Canada
Email: orderlit@onsemi.com

N. American Technical Support: 800-282-9855
Toll Free USA/Canada
Europe, Middle East and Africa Technical Support:
Phone: 421 33 790 2910
Japan Customer Focus Center
Phone: 81-3-5773-3850

ON Semiconductor Website:
www.onsemi.com

Order Literature: <http://www.onsemi.com/orderlit>

For additional information, please contact your local Sales Representative