



Chipsmall Limited consists of a professional team with an average of over 10 year of expertise in the distribution of electronic components. Based in Hongkong, we have already established firm and mutual-benefit business relationships with customers from,Europe,America and south Asia,supplying obsolete and hard-to-find components to meet their specific needs.

With the principle of “Quality Parts,Customers Priority,Honest Operation,and Considerate Service”,our business mainly focus on the distribution of electronic components. Line cards we deal with include Microchip,ALPS,ROHM,Xilinx,Pulse,ON,Everlight and Freescale. Main products comprise IC,Modules,Potentiometer,IC Socket,Relay,Connector.Our parts cover such applications as commercial,industrial, and automotives areas.

We are looking forward to setting up business relationship with you and hope to provide you with the best service and solution. Let us make a better world for our industry!



Contact us

Tel: +86-755-8981 8866 Fax: +86-755-8427 6832

Email & Skype: info@chipsmall.com Web: www.chipsmall.com

Address: A1208, Overseas Decoration Building, #122 Zhenhua RD., Futian, Shenzhen, China



High Surge Current Series - DO-214



Agency Approvals

Agency	Agency File Number
	E133083

Pinout Designation

Not Applicable

Schematic Symbol



Description

The High Surge Current DO-214 Series are SIDACtor® thyristors designed to protect equipment located in hostile environments from overvoltage transients.

The series provides a 200A 10/1000 μ s rated surface mount solution that enables equipment to comply with enhanced surge requirements now specified in regulatory and customer requirements.

Features and Benefits

- Low voltage overshoot
 - Low on-state voltage
 - Does not degrade surge capability after multiple surge events within limit.
 - Fails short circuit when surged in excess of ratings
 - 200A 10x1000 Surge
- Rating
- 1000A 2x10 Surge Rating
 - RoHS Compliant and Halogen-Free
 - Pb-free E3 means 2nd level interconnect is Pb-free and the terminal finish material is tin(Sn) (IPC/JEDEC J-STD-609A.01)

Applicable Global Standards

- TIA-968-A
- TIA-968-B
- ITU K.20/21/45 Enhanced Level
- ITU K.20/21/45 Basic Level
- GR 1089 Inter-building
- GR 1089 Intra-building
- IEC 61000-4-5 2nd edition
- YD/T 1082
- YD/T 993
- YD/T 950

Electrical Characteristics

Part Number	Marking	V_{DRM} @ $I_{DRM}=5\mu A$	V_s @ 100V/ μ s	I_H	I_s	I_{T++}	V_T @ $I_T=2.2A$	Capacitance @ 1MHz, 2V bias	
		V min	V max	mA min	mA max	A max	V max	pf min	pF max
P0080SDLRP	P-8D	6	25	50	800	2.2	4	50	150
P0640SDLRP	P06D	58	77	50	800	2.2	4	100	160
P0720SDLRP	P07D	65	88	50	800	2.2	4	100	150
P0900SDLRP	P09D	75	98	50	800	2.2	4	95	140
P1100SDLRP	P11D	90	130	50	800	2.2	4	75	115
P1300SDLRP	P13D	120	160	50	800	2.2	4	65	100
P1500SDLRP	P15D	140	180	50	800	2.2	4	60	90
P1800SDLRP	P18D	170	220	50	800	2.2	4	50	90
P2300SDLRP	P23D	190	260	50	800	2.2	4	50	80
P2600SDLRP	P26D	220	300	50	800	2.2	4	50	75
P3100SDLRP	P31D	275	350	50	800	2.2	4	45	70
P3500SDLRP	P35D	320	400	50	800	2.2	4	45	65

Notes:

- Absolute maximum ratings measured at $T_a = 25^\circ C$ (unless otherwise noted).

- Components are bi-directional (unless otherwise noted).

** Will meet 4.4A power cross requirement without fire hazard.

Surge Ratings

Series	I_{PP}									I_{TSM} 50/60 Hz	di/dt
	0.2/310 ¹	2/10 ¹	8/20 ¹	10/160 ¹	10/560 ¹	5/320 ¹	10/360 ¹	10/1000 ¹	5/310 ¹		
	0.5/700 ²	2/10 ²	1.2/50 ²	10/160 ²	10/560 ²	9/720 ²	10/360 ²	10/1000 ²	10/700 ²		
	A min	A min	A min	A min	A min	A min	A min	A min	A min	A min	A/μs max
D	—	1000	800	—	—	—	—	200	350	50	1000

Notes:

- 1 Current waveform in μs
- 2 Voltage waveform in μs
- Peak pulse current rating (I_{pp}) is repetitive and guaranteed for the life of the product that remains in thermal equilibrium.
- I_{pp} ratings applicable over temperature range of -40°C to +85°C
- The component must initially be in thermal equilibrium with -40°C ≤ T_J ≤ +150°C

Thermal Considerations

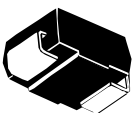
Package	Symbol	Parameter	Value	Unit
DO-214AA 	T_J	Operating Junction Temperature Range	-40 to +150	°C
	T_S	Storage Temperature Range	-65 to +150	°C
	$R_{\theta JA}$	Thermal Resistance: Junction to Ambient	90	°C/W

V-I Characteristics

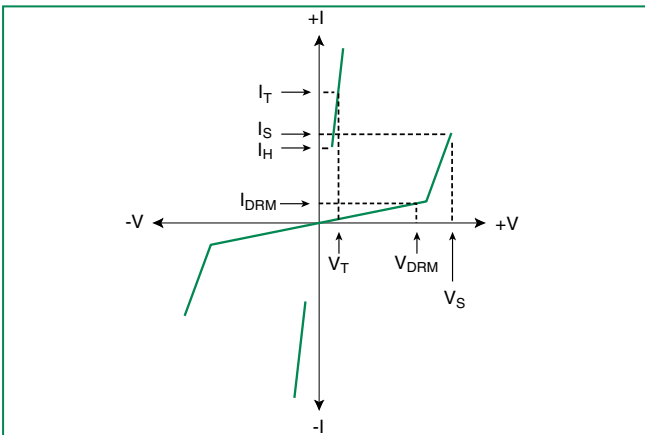

$t_r \times t_d$ Pulse Waveform

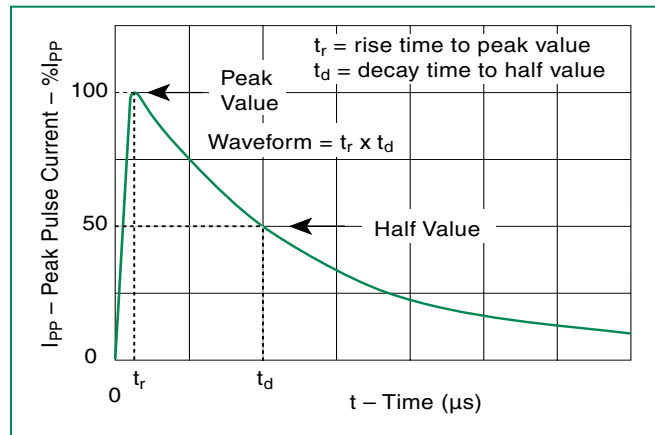

Normalized V_S Change vs. Junction Temperature

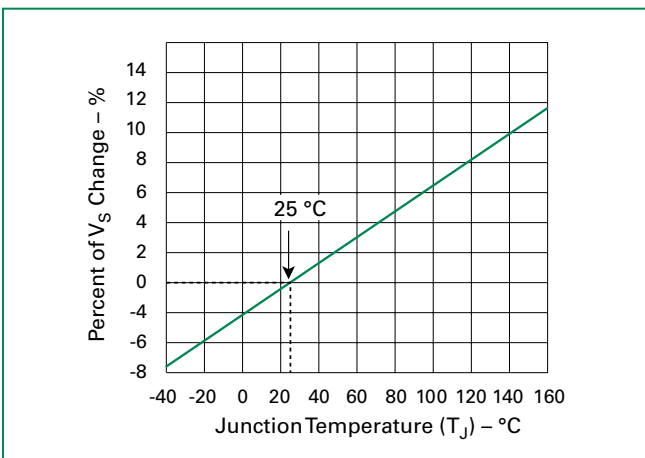

Normalized DC Holding Current vs. Case Temperature

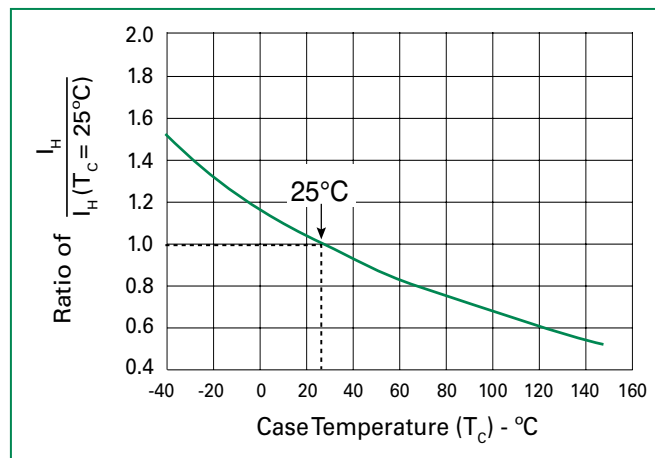

Soldering Parameters

Reflow Condition	Pb-Free assembly (see Fig. 1)	
Pre Heat	-Temperature Min ($T_{s(min)}$)	+150°C
	-Temperature Max ($T_{s(max)}$)	+200°C
	-Time (Min to Max) (t_s)	60-180 secs.
Average ramp up rate (Liquidus Temp (T_L) to peak)	3°C/sec. Max.	
$T_{s(max)}$ to T_L - Ramp-up Rate	3°C/sec. Max.	
Reflow	-Temperature (T_L) (Liquidus)	+217°C
	-Temperature (t_L)	60-150 secs.
Peak Temp (T_p)	+260(+0/-5)°C	
Time within 5°C of actual PeakTemp (t_p)	30 secs. Max.	
Ramp-down Rate	6°C/sec. Max.	
Time 25°C to Peak Temp (T_p)	8 min. Max.	
Do not exceed	+260°C	

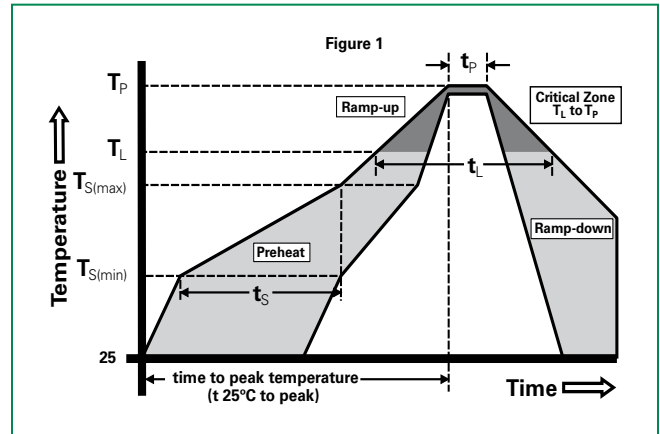

Physical Specifications

Lead Material	Copper Alloy
Terminal Finish	100% Matte-Tin Plated
Body Material	UL Recognized epoxy meeting flammability classification V-0 per Underwriters Laboratories

Environmental Specifications

High Temp Voltage Blocking	80% Rated V_{DRM} ($V_{AC Peak}$) +125°C or +150°C, 504 or 1008 hrs. MIL-STD-750 (Method 1040) JEDEC, JESD22-A-101
Temp Cycling	-65°C to +150°C, 15 min. dwell, 10 up to 100 cycles. MIL-STD-750 (Method 1051) EIA/JEDEC, JESD22-A-104
Biased Temp & Humidity	52 V_{DC} (+85°C) 85%RH, 504 up to 1008 hrs. EIA/JEDEC, JESD22-A-101
High Temp Storage	+150°C 1008 hrs. MIL-STD-750 (Method 1031) JEDEC, JESD22-A-101
Low Temp Storage	-65°C, 1008 hrs.
Thermal Shock	0°C to +100°C, 5 min. dwell, 10 sec. transfer, 10 cycles. MIL-STD-750 (Method 1056) JEDEC, JESD22-A-106
Autoclave (Pressure Cooker Test)	+121°C, 100%RH, 2atm, 24 up to 168 hrs. EIA/JEDEC, JESD22-A-102
Resistance to Solder Heat	+260°C, 30 secs. MIL-STD-750 (Method 2031)
Moisture Sensitivity Level	85%RH, +85°C, 168 hrs., 3 reflow cycles (+260°C Peak). JEDEC-J-STD-020, Level 1

Part Numbering

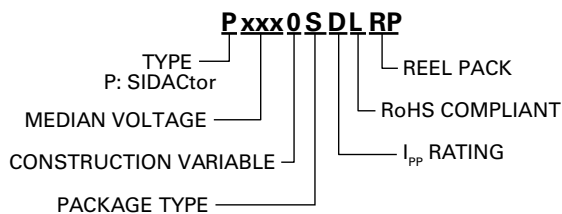

Part Marking

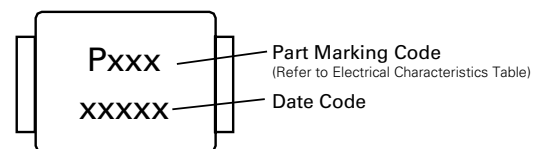

Dimensions – DO-214AA

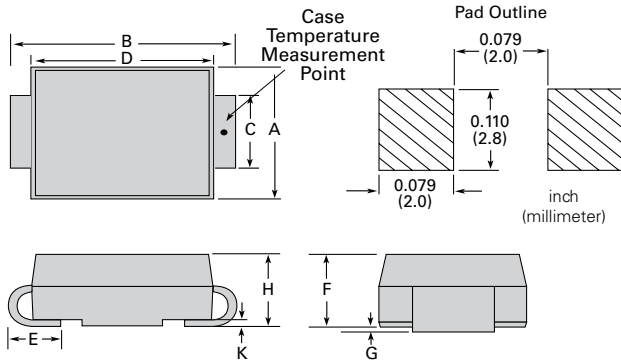

Dimensions	Inches		Millimeters	
	Min	Max	Min	Max
A	0.130	0.156	3.30	3.95
B	0.201	0.220	5.10	5.60
C	0.077	0.087	1.95	2.20
D	0.159	0.181	4.05	4.60
E	0.030	0.063	0.75	1.60
F	0.075	0.096	1.90	2.45
G	0.002	0.008	0.05	0.20
H	0.077	0.104	1.95	2.65
K	0.006	0.016	0.15	0.41

Packing Options

Package Type	Description	Quantity	Added Suffix	Industry Standard
S	DO-214AA Tape and Reel Pack	2500	RP	EIA-481-D

Tape and Reel Specification – DO-214AA

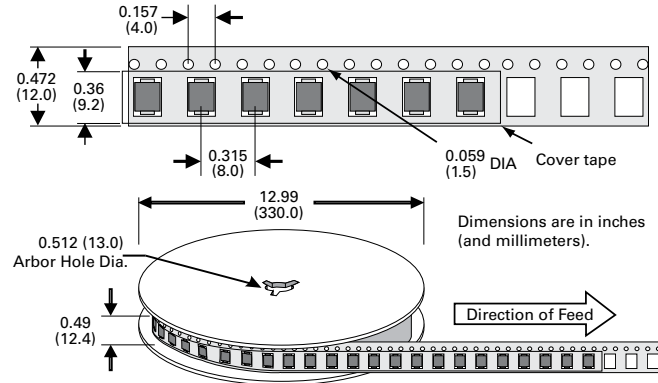

Additional Information



Datasheet



Resources



Samples