



Chipsmall Limited consists of a professional team with an average of over 10 year of expertise in the distribution of electronic components. Based in Hongkong, we have already established firm and mutual-benefit business relationships with customers from,Europe,America and south Asia,supplying obsolete and hard-to-find components to meet their specific needs.

With the principle of “Quality Parts,Customers Priority,Honest Operation,and Considerate Service”,our business mainly focus on the distribution of electronic components. Line cards we deal with include Microchip,ALPS,ROHM,Xilinx,Pulse,ON,Everlight and Freescale. Main products comprise IC,Modules,Potentiometer,IC Socket,Relay,Connector.Our parts cover such applications as commercial,industrial, and automotives areas.

We are looking forward to setting up business relationship with you and hope to provide you with the best service and solution. Let us make a better world for our industry!



Contact us

Tel: +86-755-8981 8866 Fax: +86-755-8427 6832

Email & Skype: info@chipsmall.com Web: www.chipsmall.com

Address: A1208, Overseas Decoration Building, #122 Zhenhua RD., Futian, Shenzhen, China



P3P85R01A

3.3V, 75 MHz to 200 MHz LVCMOS TIMING SAFE™ Peak EMI Reduction Device

Functional Description

P3P85R01A is a versatile, 3.3 V, LVCMOS, wide frequency range, TIMING SAFE Peak EMI reduction device. TIMING SAFE technology is the ability to modulate a clock source with Spread Spectrum technology and maintain synchronization with any associated data path. Refer to Figure 3.

P3P85R01A has an SSEXTR pin that selects different frequency deviations depending upon the value of the resistor connected between this pin and GND.

P3P85R01A has a DLY_CTRL pin used for adjusting the Input-Output clock delay, depending upon the value of capacitor connected at this pin to GND. The DLY_CTRL output phase is complementary to that of ModOUT clock. This signal enables better EMI management.

P3P85R01A has a Bypass pin to bypass PLL. The device works from 100 Hz to 200 MHz with a fixed input to output delay when in Bypass mode.

P3P85R01A has a PLLOUT_DLY for adjusting the PLL Output clock delay during power up time depending upon the value of capacitor connected at this pin to VDD. During power up time, ModOUT will be of the same frequency as CLKIN with a fixed input to output delay.

General Features

- 1x, LVCMOS Peak EMI Reduction
- Input Frequency Range: 75 MHz – 200 MHz
- Output Frequency Range: 75 MHz – 200 MHz
- Analog Deviation Selection
- Analog Input–Output Delay Control
- Analog PLL Output Delay Control
- Low Cycle–to–Cycle Jitter
- Supply Voltage: 3.3 V ± 0.3 V
- 8 pin, WDFN, 2 mm x 2 mm (TDFN) Package
- Operating Temperature Range: 0°C to +70°C
- These Devices are Pb–Free, Halogen Free/BFR Free and are RoHS Compliant

Application

- P3P85R01A is targeted for use in Displays, Giga LAN and SDRAM applications.



ON Semiconductor®

<http://onsemi.com>

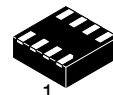

WDFN8
CASE 511AQ

MARKING DIAGRAMS

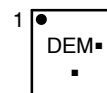

DE = Specific Device Code

M = Date Code

▪ = Pb–Free Device

(Note: Microdot may be in either location)

PIN CONFIGURATION

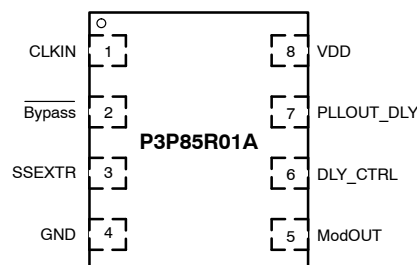

ORDERING INFORMATION

See detailed ordering and shipping information in the package dimensions section on page 7 of this data sheet.

P3P85R01A

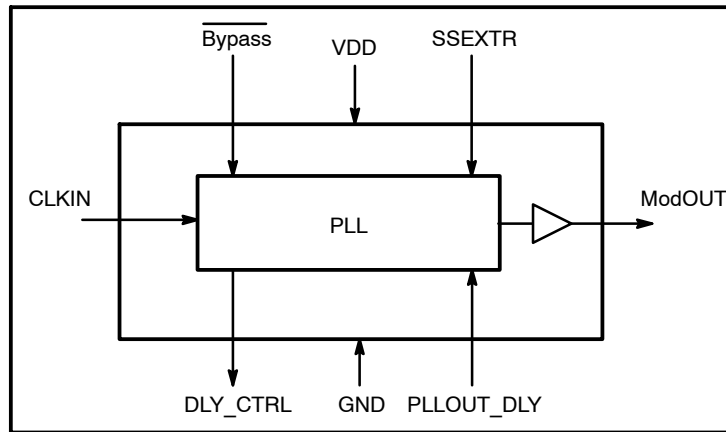

Figure 1. Block Diagram

Table 1. PIN DESCRIPTION

Pin#	Pin Name	Type	Description
1	CLKIN	Input	External reference Clock Input
2	Bypass	Input	Bypass mode. When LOW device is in PLL Bypass mode. When HIGH PLL, mode is enabled
3	SSEXTR	Input	Analog Deviation Selection through an external resistor to GND.
4	GND	Power	Ground
5	ModOUT	Output	Buffered Modulated Clock output
6	DLY_CTRL	Output	Analog Input-Output Delay Control through an external capacitor to GND. Output used for EMI management
7	PLLOUT_DLY	Input	Analog PLL output delay control during power-up time, through an external capacitor to VDD
8	VDD	Power	Supply Voltage

Table 2. OPERATING CONDITIONS

Symbol	Description	Min	Max	Unit
V_{DD}	Supply Voltage	3.0	3.6	V
T_A	Operating Temperature (Ambient Temperature)	0	70	°C
C_{IN}	Input Capacitance		7	pF

Table 3. ABSOLUTE MAXIMUM RATING

Symbol	Parameter	Rating	Unit
V_{DD}, V_{IN}	Voltage on any input pin with respect to Ground	-0.5 to +4.6	V
T_{STG}	Storage temperature	-65 to +125	°C
T_s	Max. Soldering Temperature (10 sec)	260	°C
T_J	Junction Temperature	150	°C
T_{DV}	Static Discharge Voltage (As per JEDEC STD22-A114-B)	2	kV

Stresses exceeding Maximum Ratings may damage the device. Maximum Ratings are stress ratings only. Functional operation above the Recommended Operating Conditions is not implied. Extended exposure to stresses above the Recommended Operating Conditions may affect device reliability.

P3P85R01A

Table 4. ELECTRICAL CHARACTERISTICS

Symbol	Parameter	Test Conditions	Min	Typ	Max	Unit
V _{DD}	Supply Voltage		3.0	3.3	3.6	V
V _{IL}	Input LOW Voltage				0.8	V
V _{IH}	Input HIGH Voltage		2.0			V
I _{IL}	Input LOW Current	V _{IN} = 0 V			50	μA
I _{IH}	Input HIGH Current	V _{IN} = V _{DD}			50	μA
V _{OL}	Output LOW Voltage (Note 1)	I _{OL} = 8 mA			0.4	V
V _{OH}	Output HIGH Voltage (Note 1)	I _{OH} = -8 mA	2.4			V
I _{CC}	Static Supply Current	CLKIN pin pulled LOW			100	μA
I _{DD}	Dynamic Supply Current	Unloaded output			50	mA
C _L	Load Capacitance	@ 200 MHz		10		pF
Z _o	Output Impedance			27		Ω

1. Parameter is guaranteed by design and characterization. Not tested in production

Table 5. SWITCHING CHARACTERISTICS

Parameter	Test Conditions	Min	Typ	Max	Unit
Input Frequency		75		200	MHz
Output Frequency		75		200	MHz
Duty Cycle (Note 2) = (t ₂ / t ₁) * 100	Measured at V _{DD} / 2	40	49 – 51	60	%
Output Rise Time (t ₃) (Notes 2 and 3)	Measured between 20% to 80%			2	ns
Output Fall Time (t ₄) (Notes 2 and 3)	Measured between 80% to 20%			1.8	ns
Delay, CLKIN Rising Edge to ModOUT Rising Edge (t ₅) (Notes 2 and 4)	@ 133 MHz, Variable Delay mode		-500		ps
	Fixed Delay mode		1.4	1.7	ns
Load line	Change in Input-Output delay, SSEXTR = OPEN	on DLY_CTRL		-40	ps/pF
		on ModOUT		40	
PLL OUT Delay Time (Note 5)	PLLOUT_DLY pin left OPEN		1		ms
Cycle-to-cycle Jitter (Note 2)	Unloaded Outputs @ 133 MHz		±100		ps
PLL Lock Time (Note 2)	Stable power supply, valid clock presented on CLKIN			1	ms
Device-to-Device variation of Deviation and I/O delay			±20		%

2. Parameter is guaranteed by design and characterization. Not tested in production

3. All parameters are specified with 10 pF – loaded outputs.

4. 10 pF load on ModOUT, DLY_CTRL and SSEXT pins left OPEN.

5. Parameter is guaranteed by design.

P3P85R01A

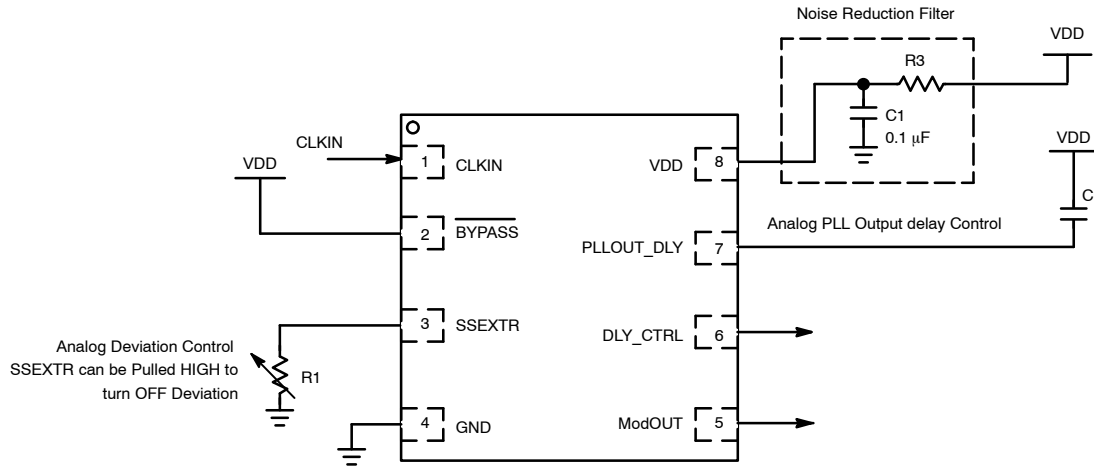

NOTES: Refer to Pin Description table for Functionality details.

Figure 2. Application Schematic

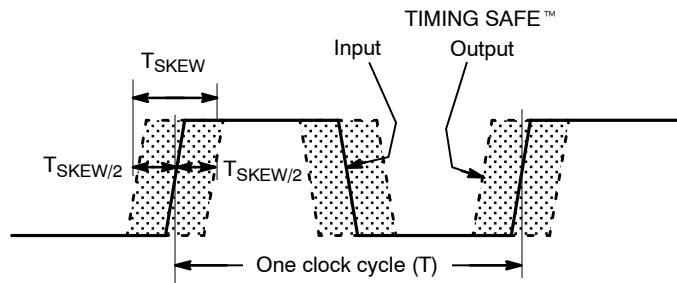

T_{SKEW} represents input-output skew when spread spectrum is ON
For example, T_{SKEW/2} = 0.20 x T for an Input clock of 75 MHz,
translates into (1/75 MHz) x 0.20 = 2.66 nS

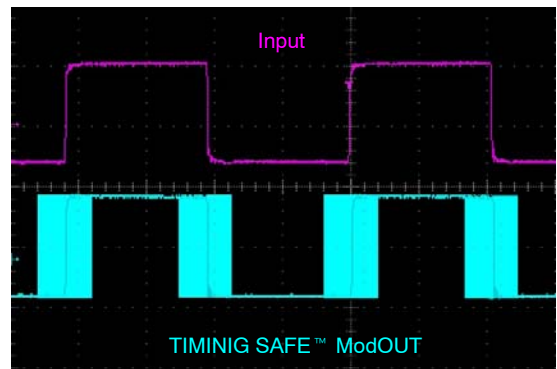
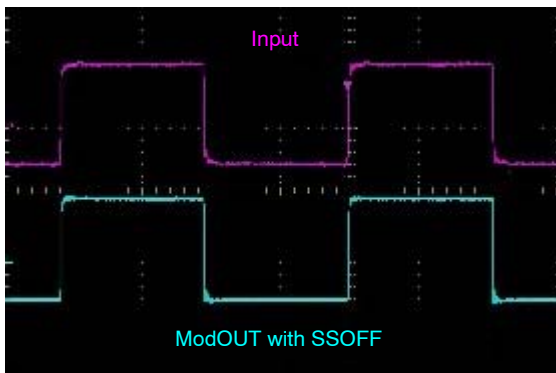

Figure 3. Typical Example of TIMING SAFE™ Waveform

P3P85R01A

SWITCHING WAVEFORMS

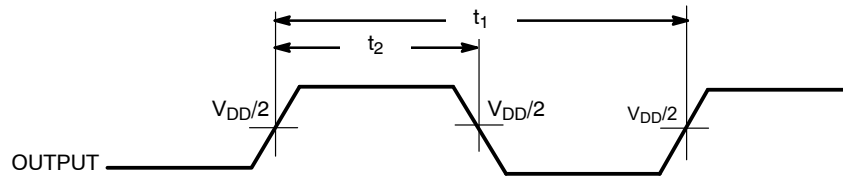

Figure 4. Duty Cycle Timing

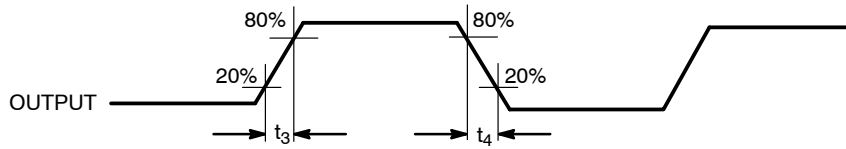

Figure 5. Output Rise/Fall Time

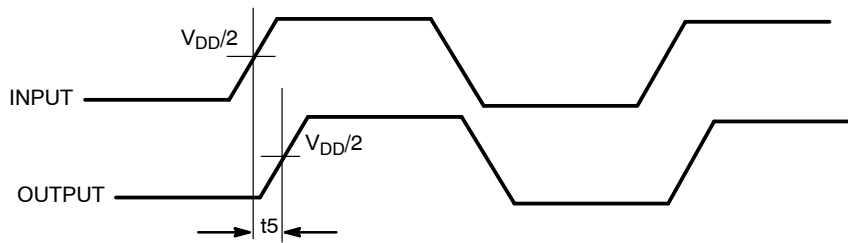

Figure 6. Input - Output Propagation Delay

P3P85R01A

CHARTS

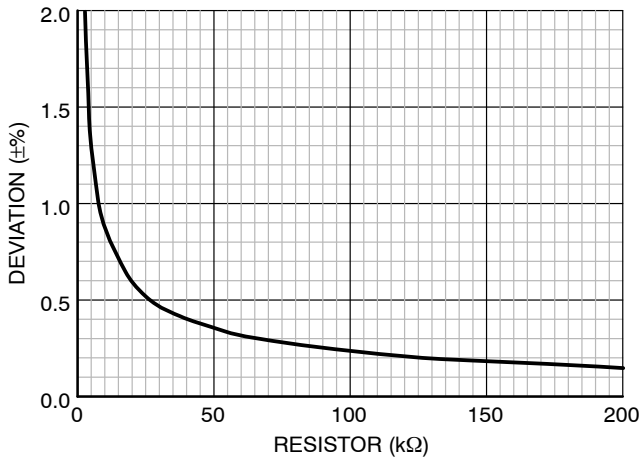

Figure 7. Deviation vs. SSEXT @ 106 MHz

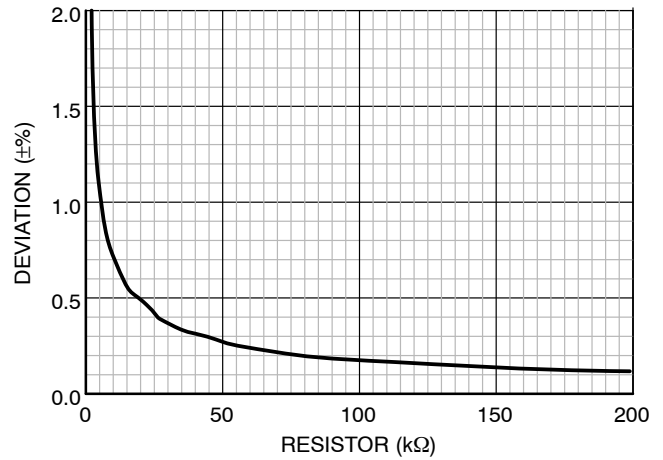

Figure 8. Deviation vs. SSEXT @ 125 MHz

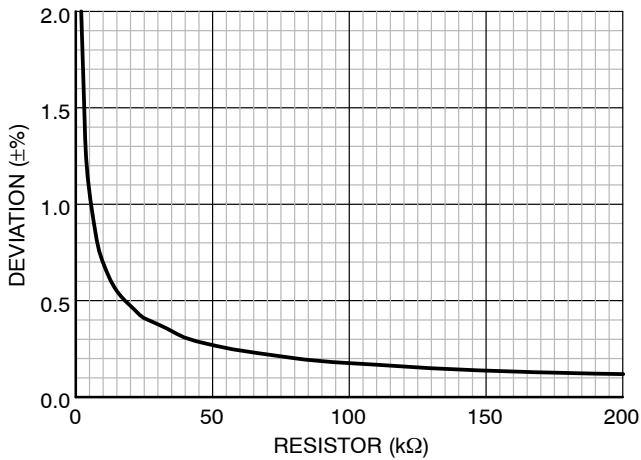

Figure 9. Deviation vs. SSEXT @ 133 MHz

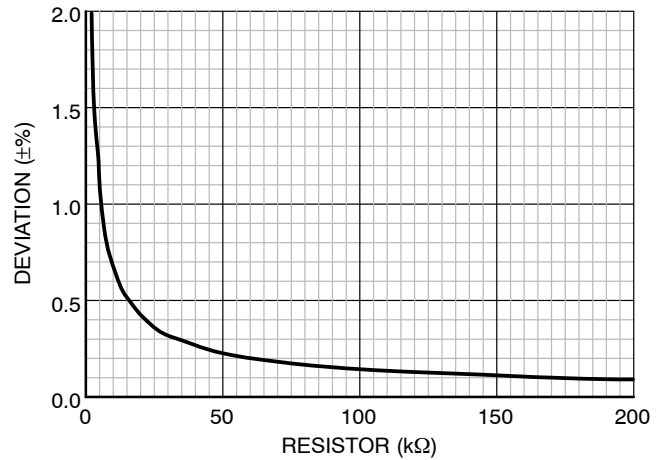

Figure 10. Deviation vs. SSEXT @ 145 MHz

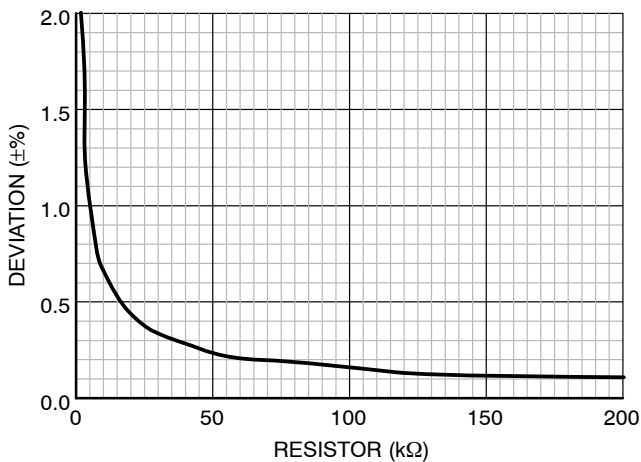

Figure 11. Deviation vs. SSEXT @ 156 MHz

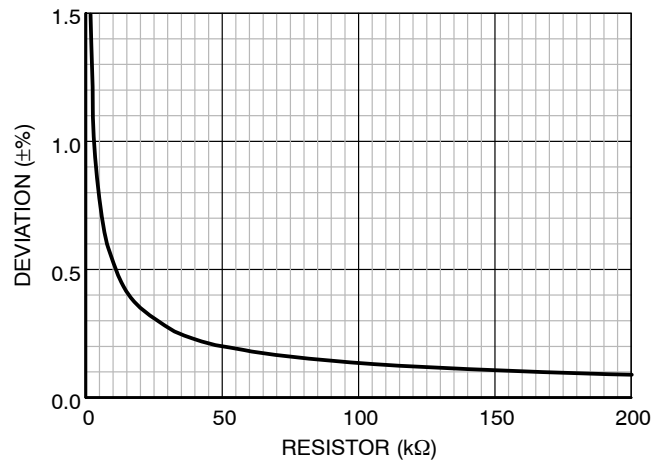

Figure 12. Deviation vs. SSEXT @ 166 MHz

P3P85R01A

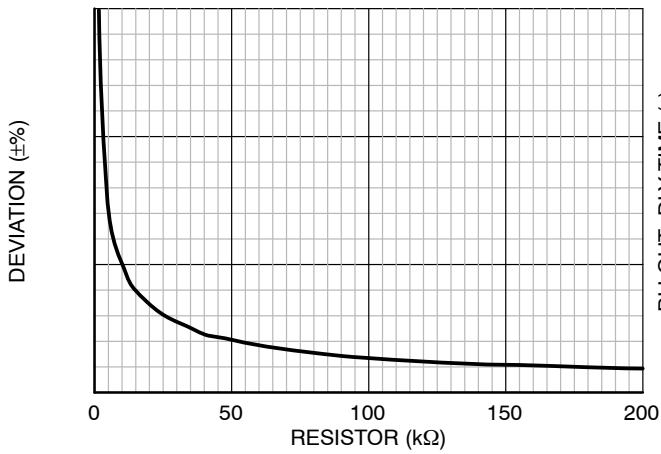

Figure 13. Deviation vs. SSEXTR @ 175 MHz

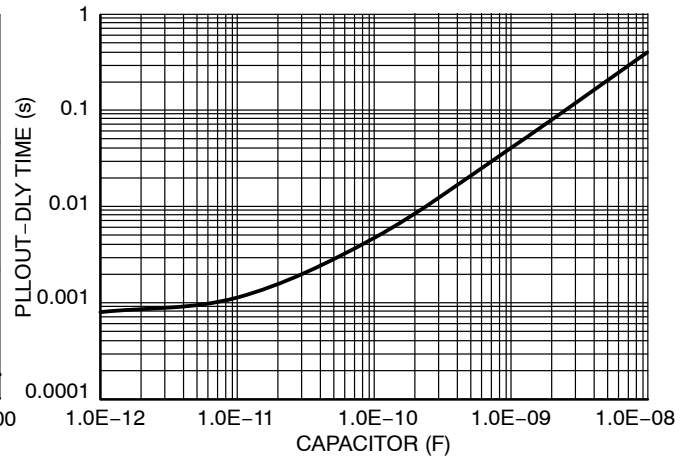

Figure 14. PLLOUT-DLY Time vs. Capacitor

ORDERING INFORMATION

Part Number	Top Marking	Temperature	Package Type	Shipping†
P3P85R01AG-08CR	DE	0°C to +70°C	WDFN8 (2mm x 2mm) (Pb-Free)	3000 / Tape & Reel

†For information on tape and reel specifications, including part orientation and tape sizes, please refer to our Tape and Reel Packaging Specifications Brochure, BRD8011/D.

*A "microdot" placed at the end of last row of marking or just below the last row toward the center of package indicates Pb-Free.

P3P85R01A

PACKAGE DIMENSIONS

WDFN8 2x2, 0.5P
CASE 511AQ-01
ISSUE A

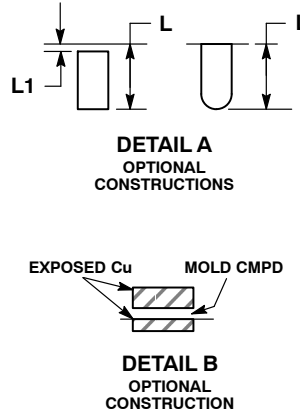
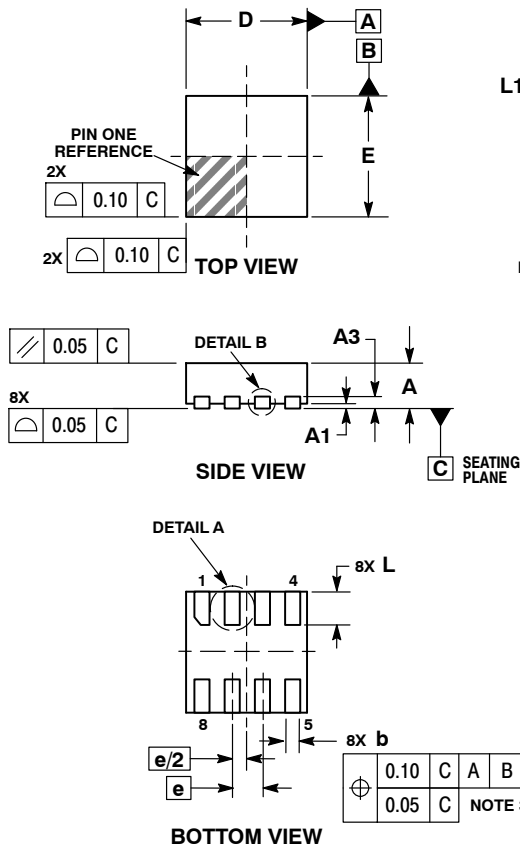

- NOTES:
1. DIMENSIONING AND TOLERANCING PER ASME Y14.5M, 1994.
 2. CONTROLLING DIMENSION: MILLIMETERS.
 3. DIMENSION b APPLIES TO PLATED TERMINAL AND IS MEASURED BETWEEN 0.15 AND 0.30mm FROM TERMINAL.

DIM	MILLIMETERS	
	MIN	MAX
A	0.70	0.80
A1	0.00	0.05
A3	0.20 REF	
b	0.20	0.30
D	2.00 BSC	
E	2.00 BSC	
e	0.50 BSC	
L	0.50	0.60
L1	---	0.15

RECOMMENDED SOLDERING FOOTPRINT*

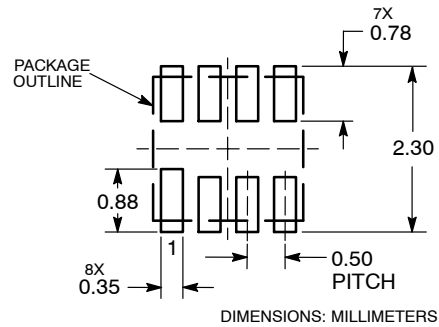

*For additional information on our Pb-Free strategy and soldering details, please download the ON Semiconductor Soldering and Mounting Techniques Reference Manual, SOLDERRM/D.

TIMING SAFE is a trademark of Semiconductor Components Industries, LLC (SCILLC).

ON Semiconductor and are registered trademarks of Semiconductor Components Industries, LLC (SCILLC). SCILLC reserves the right to make changes without further notice to any products herein. SCILLC makes no warranty, representation or guarantee regarding the suitability of its products for any particular purpose, nor does SCILLC assume any liability arising out of the application or use of any product or circuit, and specifically disclaims any and all liability, including without limitation special, consequential or incidental damages. "Typical" parameters which may be provided in SCILLC data sheets and/or specifications can and do vary in different applications and actual performance may vary over time. All operating parameters, including "Typicals" must be validated for each customer application by customer's technical experts. SCILLC does not convey any license under its patent rights nor the rights of others. SCILLC products are not designed, intended, or authorized for use as components in systems intended for surgical implant into the body, or other applications intended to support or sustain life, or for any other application in which the failure of the SCILLC product could create a situation where personal injury or death may occur. Should Buyer purchase or use SCILLC products for any such unintended or unauthorized application, Buyer shall indemnify and hold SCILLC and its officers, employees, subsidiaries, affiliates, and distributors harmless against all claims, costs, damages, and expenses, and reasonable attorney fees arising out of, directly or indirectly, any claim of personal injury or death associated with such unintended or unauthorized use, even if such claim alleges that SCILLC was negligent regarding the design or manufacture of the part. SCILLC is an Equal Opportunity/Affirmative Action Employer. This literature is subject to all applicable copyright laws and is not for resale in any manner.

PUBLICATION ORDERING INFORMATION

LITERATURE FULFILLMENT:
Literature Distribution Center for ON Semiconductor
P.O. Box 5163, Denver, Colorado 80217 USA
Phone: 303-675-2175 or 800-344-3860 Toll Free USA/Canada
Fax: 303-675-2176 or 800-344-3867 Toll Free USA/Canada
Email: orderlit@onsemi.com

N. American Technical Support: 800-282-9855 Toll Free USA/Canada
Europe, Middle East and Africa Technical Support:
Phone: 421 33 790 2910
Japan Customer Focus Center
Phone: 81-3-5773-3850

ON Semiconductor Website: www.onsemi.com
Order Literature: <http://www.onsemi.com/orderlit>
For additional information, please contact your local Sales Representative