



Chipsmall Limited consists of a professional team with an average of over 10 year of expertise in the distribution of electronic components. Based in Hongkong, we have already established firm and mutual-benefit business relationships with customers from,Europe,America and south Asia,supplying obsolete and hard-to-find components to meet their specific needs.

With the principle of “Quality Parts,Customers Priority,Honest Operation,and Considerate Service”,our business mainly focus on the distribution of electronic components. Line cards we deal with include Microchip,ALPS,ROHM,Xilinx,Pulse,ON,Everlight and Freescale. Main products comprise IC,Modules,Potentiometer,IC Socket,Relay,Connector.Our parts cover such applications as commercial,industrial, and automotives areas.

We are looking forward to setting up business relationship with you and hope to provide you with the best service and solution. Let us make a better world for our industry!



Contact us

Tel: +86-755-8981 8866 Fax: +86-755-8427 6832

Email & Skype: info@chipsmall.com Web: www.chipsmall.com

Address: A1208, Overseas Decoration Building, #122 Zhenhua RD., Futian, Shenzhen, China



3M™ Pak 50 Low Profile Socket

.050" Low Profile, Right Angle Stacking Socket

P50L Series

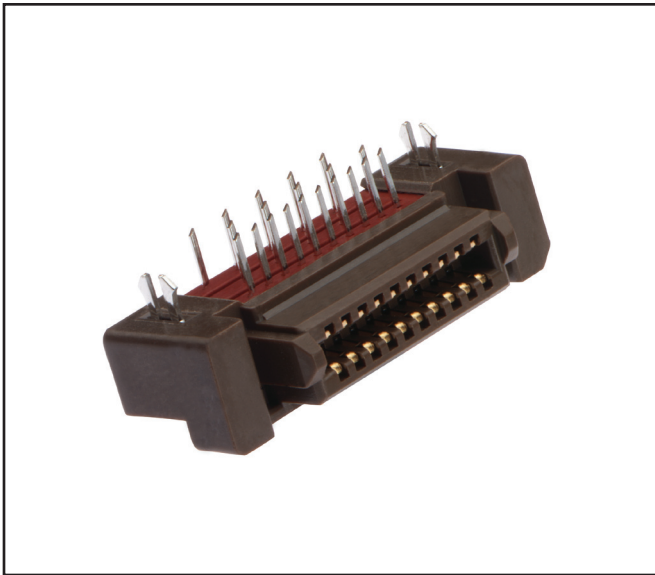

- Low profile 0.276" (7 mm) from PCB surface
- High temperature insulator compatible with IR and wave soldering
- Optional plug standoffs allow offset of mated board by 1.0 - 4.0 mm
- Retention clips stabilize connector to the board during wave soldering
- RoHS Compliant. See the Regulatory Information Appendix (RIA) in the "RoHS Compliance" section of www.3Mconnector.com for compliance information (RIA E1 and C1 apply)

Date Modified: February 11, 2010

TS-1146-B
Sheet 1 of 2

Physical

Insulator:

Material: Glass Filled PPS

Flammability: UL 94V-0

Color: Brown

Contact Material: Phosphor Bronze

Plating:

Underplating: Nickel

Wiping Area: Gold Flash

Solder Tails: Gold Flash

Retaining Clips: Tin-Copper

Mating Compatibility: TS-1145 , TS-1161, TS-2053

Electrical

Current Rating: 0.5 A

Insulation Resistance: $> 1 \times 10^9 \Omega$ at 500 V_{DC}

Withstanding Voltage: 650 V_{AC} for 1 minute

Environmental

Temperature Rating: -55°C to +85°C

Process Rating: 260°C MSL1 (per J-STD-020C)

UL File No.: E68080

3M
Electronic Solutions Division
Interconnect Solutions
<http://www.3Mconnector.com>

3M is a trademark of 3M Company.
For technical, sales or ordering information call
800-225-5373

3M™ Pak 50 Low Profile Socket

.050" Low Profile, Right Angle Stacking Socket

P50L Series

Product Table / Dimensions

Contact Quantity	A	B	C	D	E	F
20	25.43 [1.001]	20.32 [0.800]	17.03 [0.670]	15.43 [0.607]	11.43 [0.450]	14.23 [0.560]
30	31.78 [1.251]	26.67 [1.050]	23.38 [0.920]	21.78 [0.857]	17.78 [0.700]	20.58 [0.810]
40	38.13 [1.501]	33.02 [1.300]	29.73 [1.170]	28.13 [1.107]	24.13 [0.950]	26.93 [1.060]
50	44.48 [1.751]	39.37 [1.550]	36.08 [1.420]	34.48 [1.357]	30.48 [1.200]	33.28 [1.310]
60	50.83 [2.001]	45.72 [1.800]	42.43 [1.670]	40.83 [1.607]	36.83 [1.450]	39.63 [1.560]
80	63.53 [2.501]	58.42 [2.300]	55.13 [2.170]	53.53 [2.107]	49.53 [1.950]	52.33 [2.060]
100	76.23 [3.001]	71.12 [2.800]	67.83 [2.670]	66.23 [2.607]	62.23 [2.450]	65.03 [2.560]
120	88.93 [3.501]	83.82 [3.300]	80.53 [3.170]	78.93 [3.107]	74.93 [2.950]	77.73 [3.060]

X-X' Cross Section

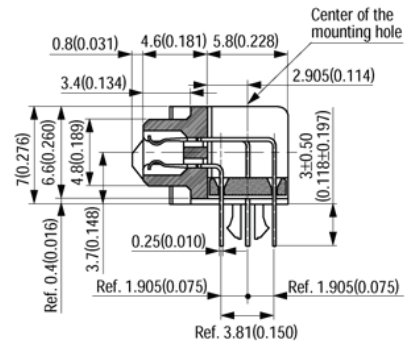

Printed Circuit Board Layout (Component Side View)

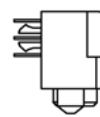
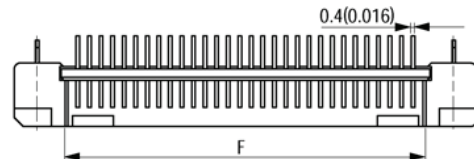
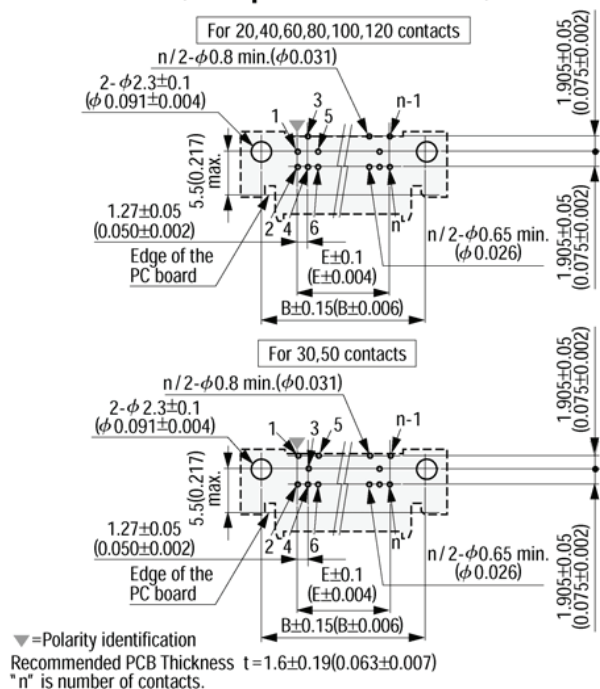

Polarity identification

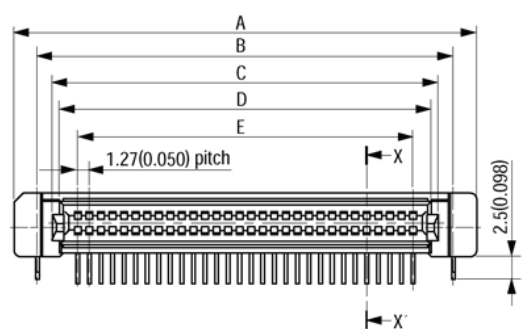
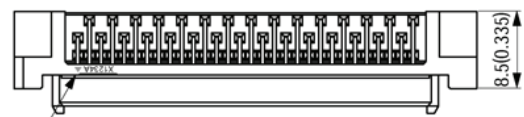

Ordering Information

P50L - XXXS - RR1 - DA (RIA E1 and C1 apply)

Contact Quantity: _____
 See Table

Important Notice

All statements, technical information, and recommendations related to 3M's products are based on information believed to be reliable, but the accuracy or completeness is not guaranteed. Before using this product, you must evaluate it and determine if it is suitable for your intended application. You assume all risks and liability associated with such use. Any statements related to the product which are not contained in 3M's current publications, or any contrary statements contained on your purchase order shall have no force or effect unless expressly agreed upon, in writing, by an authorized officer of 3M.

Warranty; Limited Remedy; Limited Liability.

This product will be free from defects in material and manufacture for a period of one (1) year from the time of purchase. **3M MAKES NO OTHER WARRANTIES INCLUDING, BUT NOT LIMITED TO, ANY IMPLIED WARRANTY OF MERCHANTABILITY OR FITNESS FOR A PARTICULAR PURPOSE.** If this product is defective within the warranty period stated above, your exclusive remedy shall be, at 3M's option, to replace or repair the 3M product or refund the purchase price of the 3M product. **Except where prohibited by law, 3M will not be liable for any indirect, special, incidental or consequential loss or damage arising from this 3M product, regardless of the legal theory asserted.**

**3M Electronics Solutions Division**

6801 River Place Blvd.
Austin, TX 78726-9000
U.S.A.
1-800-225-5373
www.3Mconnector.com

Please recycle. Printed in USA.
© 3M 2010. All rights reserved.
RIA-2217B-E

3M is a trademark of 3M Company.