



Chipsmall Limited consists of a professional team with an average of over 10 year of expertise in the distribution of electronic components. Based in Hongkong, we have already established firm and mutual-benefit business relationships with customers from,Europe,America and south Asia,supplying obsolete and hard-to-find components to meet their specific needs.

With the principle of “Quality Parts,Customers Priority,Honest Operation,and Considerate Service”,our business mainly focus on the distribution of electronic components. Line cards we deal with include Microchip,ALPS,ROHM,Xilinx,Pulse,ON,Everlight and Freescale. Main products comprise IC,Modules,Potentiometer,IC Socket,Relay,Connector.Our parts cover such applications as commercial,industrial, and automotives areas.

We are looking forward to setting up business relationship with you and hope to provide you with the best service and solution. Let us make a better world for our industry!



## Contact us

Tel: +86-755-8981 8866 Fax: +86-755-8427 6832

Email & Skype: info@chipsmall.com Web: www.chipsmall.com

Address: A1208, Overseas Decoration Building, #122 Zhenhua RD., Futian, Shenzhen, China



# ASM5P2305A, ASM5P2309A

## 3.3 V Zero Delay Buffer

### Description

ASM5P2309A is a versatile, 3.3 V zero-delay buffer designed to distribute high-speed clocks. It accepts one reference input and drives out nine low-skew clocks. It is available in a 16-pin package. The ASM5P2305A is the eight-pin version of the ASM5P2309A. It accepts one reference input and drives out five low-skew clocks.

The -1H version of the ASM5P230xA operates at up to 133 MHz frequencies, and has higher drive than the -1 devices. All parts have on-chip PLLs that lock to an input clock on the REF. The PLL feedback is on-chip and is obtained from the CLKOUT.

ASM5P2309A has two banks of four outputs each, which can be controlled by the Select inputs as shown in the *Select Input Decoding Table*. The select input also allows the input clock to be directly applied to the outputs for chip and system testing purposes.

Multiple ASM5P2309A and ASM5P2305A devices can accept the same input clock and distribute it. In this case the skew between the outputs of the two devices is guaranteed to be less than 700 pS.

All outputs have less than 200 pS of cycle-to-cycle jitter. The input and output propagation delay is guaranteed to be less than  $\pm 350$  pS, and the output to output skew is guaranteed to be less than 200 pS.

The ASM5P2309A and the ASM5P2305A are available in two different configurations, as shown in the ordering information table. The ASM5P2305A-1 / ASM5P2309A-1 is the base part. The ASM5P2305A-1H / ASM5P2309A-1H is the high drive version of the -1 and its rise and fall times are faster than -1 part.

### Features

- 10 MHz to 133 MHz Operating Range, Compatible with CPU and PCI Bus Frequencies
- Zero Input-output Propagation Delay
- Multiple Low-skew Outputs
  - ◆ Output-output Skew less than 200 pS
  - ◆ Device-device Skew less than 700 pS
  - ◆ One Input Drives 9 Outputs, Grouped as 4 + 4 + 1 (ASM5P2309A)
  - ◆ One Input Drives 5 Outputs (ASM5P2305A)
- Less than 200 pS Cycle-to-Cycle Jitter is Compatible with Pentium® Based Systems
- Test Mode to Bypass PLL (ASM5P2309A Only, Refer to *Select Input Decoding Table*)
- Packaging Information:
  - ASM5P2309A: 16-pin SOIC, TSSOP
  - ASM5P2305A: 8-pin SOIC, TSSOP
- Commercial and Industrial Temperature Range
- 3.3 V Operation
- Advanced 0.35  $\mu$ m CMOS Technology
- These Devices are Pb-Free, Halogen Free/BFR Free and are RoHS Compliant



ON Semiconductor®

<http://onsemi.com>



SOIC-8  
S SUFFIX  
CASE 751BD



TSSOP-8  
T SUFFIX  
CASE 948AL

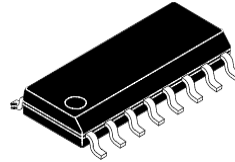

SOIC-16  
S SUFFIX  
CASE 751BG

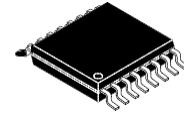

TSSOP-16  
T SUFFIX  
CASE 948AN

### PIN CONFIGURATIONS

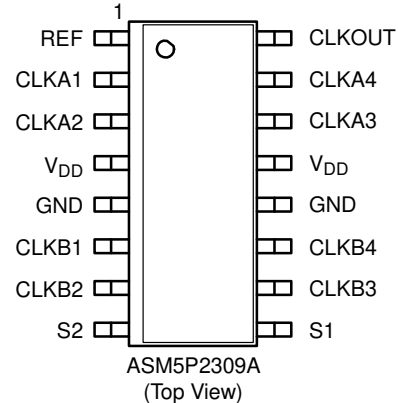
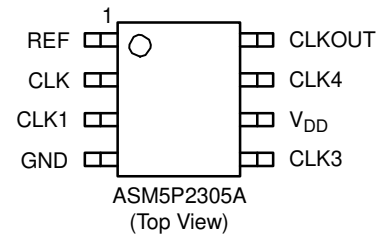

### ORDERING INFORMATION

See detailed ordering and shipping information in the package dimensions section on page 11 of this data sheet.

# ASM5P2305A, ASM5P2309A

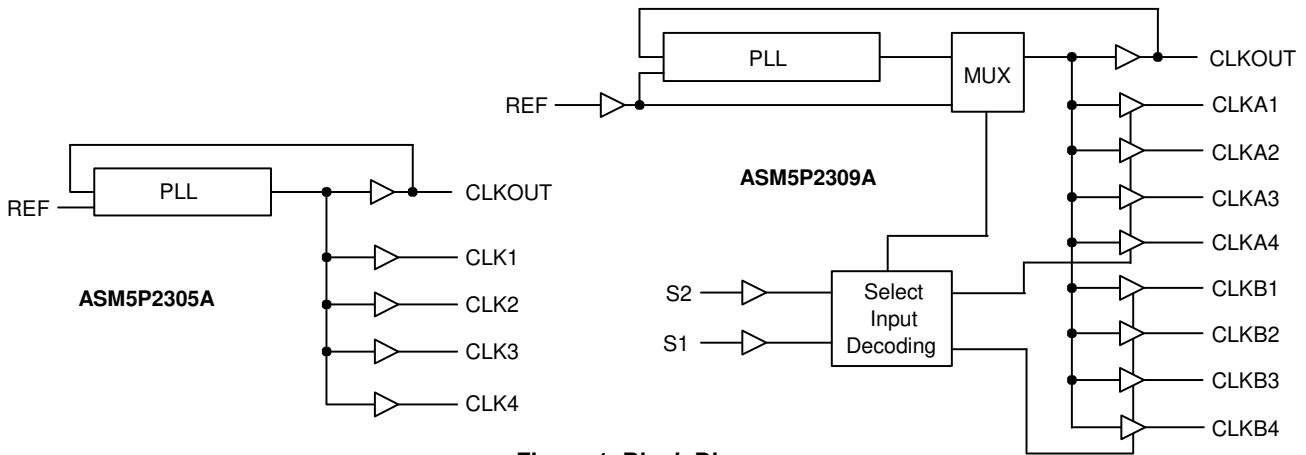

Figure 1. Block Diagram

Table 1. SELECT INPUT DECODING FOR ASM5P2309A

S2	S1	Clock A1 – A4	Clock B1 – B4	CLKOUT (Note 1)	Output Source	PLL Shut-Down
0	0	Three-state	Three-state	Driven	PLL	N
0	1	Driven	Three-state	Driven	PLL	N
1	0	Driven	Driven	Driven	Reference	Y
1	1	Driven	Driven	Driven	PLL	N

1. This output is driven and has an internal feedback for the PLL. The load on this output can be adjusted to change the skew between the reference and the output.

### Zero Delay and Skew Control

All outputs should be uniformly loaded to achieve Zero Delay between input and output. Since the CLKOUT pin is the internal feedback to the PLL, its relative loading can adjust the input-output delay.

For applications requiring zero input-output delay, all outputs, including CLKOUT, must be equally loaded. Even if CLKOUT is not used, it must have a capacitive load equal to that on other outputs, for obtaining zero input-output delay.

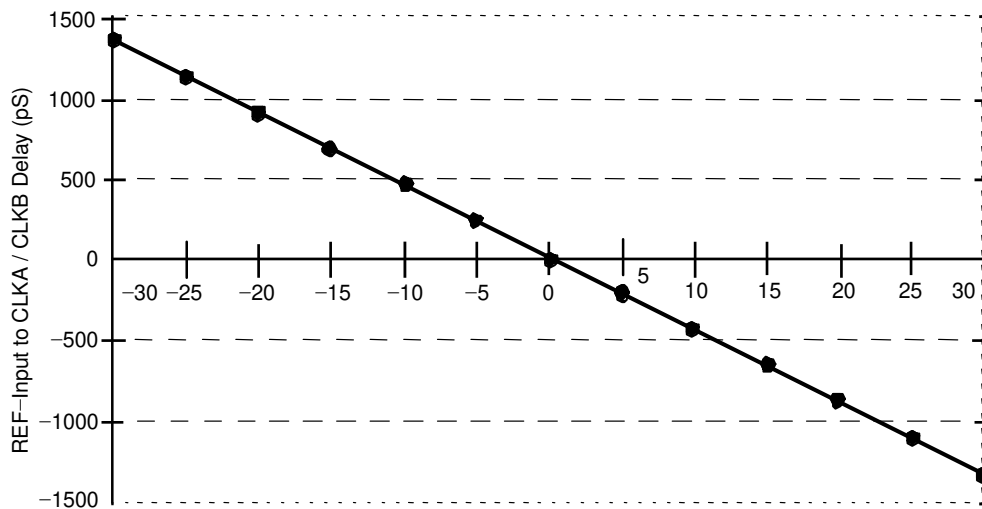

Figure 2. Output Load Difference: CLKOUT Load – CLKA/CLKB Load (pF)

## ASM5P2305A, ASM5P2309A

**Table 2. PIN DESCRIPTION FOR ASM5P2305A**

Pin #	Pin Name	Description
1	REF (Note 2)	Input reference clock frequency, 5 V-tolerant input
2	CLK2 (Note 3)	Buffered clock output
3	CLK1 (Note 3)	Buffered clock output
4	GND	Ground
5	CLK3 (Note 3)	Buffered clock output
6	V <sub>DD</sub>	3.3 V supply
7	CLK4 (Note 3)	Buffered clock output
8	CLKOUT (Note 3)	Buffered clock output, internal feedback on this pin

**Table 3. PIN DESCRIPTION FOR ASM5P2309A**

Pin #	Pin Name	Description
1	REF (Note 2)	Input reference clock frequency, 5 V tolerant input
2	CLKA1 (Note 3)	Buffered clock output, bank A
3	CLKA2 (Note 3)	Buffered clock output, bank A
4	V <sub>DD</sub>	3.3 V supply
5	GND	Ground
6	CLKB1 (Note 3)	Buffered clock output, bank B
7	CLKB2 (Note 3)	Buffered clock output, bank B
8	S2 (Note 4)	Select input, bit 2
9	S1 (Note 4)	Select input, bit 1
10	CLKB3 (Note 3)	Buffered clock output, bank B
11	CLKB4 (Note 3)	Buffered clock output, bank B
12	GND	Ground
13	V <sub>DD</sub>	3.3 V supply
14	CLKA3 (Note 3)	Buffered clock output, bank A
15	CLKA4 (Note 3)	Buffered clock output, bank A
16	CLKOUT (Note 3)	Buffered output, internal feedback on this pin

2. Weak pull-down.
3. Weak pull-down on all outputs.
4. Weak pull-up on these inputs.

# ASM5P2305A, ASM5P2309A

**Table 4. ABSOLUTE MAXIMUM RATINGS**

Parameter	Min	Max	Unit
Supply Voltage to Ground Potential	-0.5	+4.6	V
DC Input Voltage (Except REF)	-0.5	$V_{DD} + 0.5$	V
DC Input Voltage (REF)	-0.5	7	V
Storage Temperature	-65	+150	°C
Max. Soldering Temperature (10 sec)		260	°C
Junction Temperature		150	°C
Static Discharge Voltage (As per JEDEC STD22- A114-B)		2000	V

Stresses exceeding Maximum Ratings may damage the device. Maximum Ratings are stress ratings only. Functional operation above the Recommended Operating Conditions is not implied. Extended exposure to stresses above the Recommended Operating Conditions may affect device reliability.

**Table 5. OPERATING CONDITIONS** (for ASM5P2305A (-1, -1H) and ASM5P2309A (-1, -1H))

Parameter	Description	Min	Max	Unit	
$V_{DD}$	Supply Voltage	3.0	3.6	V	
$T_A$	Operating Temperature (Ambient Temperature)	Commercial temperature	0	70	°C
		Industrial temperature	-40	85	
$C_L$	Load Capacitance, below 100 MHz		30	pF	
	Load Capacitance, from 100 MHz to 133 MHz		10	pF	
$C_{IN}$	Input Capacitance		7	pF	

**Table 6. ELECTRICAL CHARACTERISTICS** (for ASM5P2305A (-1, -1H) and ASM5P2309A (-1, -1H))

Parameter	Description	Test Conditions	Min	Typ	Max	Unit
$V_{IL}$	Input LOW Voltage (Note 5)				0.8	V
$V_{IH}$	Input HIGH Voltage (Note 5)		2.2			V
$I_{IL}$	Input LOW Current	$V_{IN} = 0$ V			50	μA
$I_{IH}$	Input HIGH Current	$V_{IN} = V_{DD}$			100	μA
$V_{OL}$	Output LOW Voltage (Note 6)	$I_{OL} = 8$ mA (-1) $I_{OL} = 12$ mA (-1H)			0.4	V
$V_{OH}$	Output HIGH Voltage (Note 6)	$I_{OH} = -8$ mA (-1) $I_{OH} = -12$ mA (-1H)	2.4			V
$I_{DD}$	Supply Current	Commercial temp.			30	mA
		Industrial temp.			32	

5. REF input has a threshold voltage of  $V_{DD} / 2$ .

6. Parameter is guaranteed by design and characterization. Not 100% tested in production.

# ASM5P2305A, ASM5P2309A

**Table 7. SWITCHING CHARACTERISTICS** (for ASM5P2305A (-1, -1H) and ASM5P2309A (-1, -1H) (Notes 7, 8))

Parameter	Test Conditions	Min	Typ	Max	Unit
Output Frequency	30 pF load	10		100	MHz
	10 pF load	10		133	
Duty Cycle (Note 9)	Measured at 1.4 V, $F_{OUT} > 50$ MHz	40	50	60	%
	Measured at $V_{DD}/2$ , $F_{OUT} \leq 50$ MHz	45	50	55	
Output Rise Time (Note 9)	Measured between 0.8 V and 2.0 V	(-1)		2.25	nS
		(-1H)		1.5	
Output Fall Time (Note 9)	Measured between 2.0 V and 0.8 V	(-1)		2.25	nS
		(-1H)		1.5	
Output-to-output skew (Note 9)	All outputs equally loaded			200	pS
Delay, REF Rising Edge to CLKOUT Rising Edge (Note 9)	Measured at $V_{DD}/2$		0	$\pm 350$	pS
Device-to-Device Skew (Note 9)	Measured at $V_{DD}/2$ on the CLKOUT pins of the device		0	700	pS
Cycle-to-cycle Jitter (Note 9)	Measured at 66.67 MHz, loaded outputs			200	pS
PLL Lock Time (Note 9)	Stable power supply, valid clock presented on REF pin			1.0	mS

7. For all measurements use Test Circuit #1.

8. All parameters are specified with loaded outputs.

9. Parameter is guaranteed by design and characterization. Not 100% tested in production.

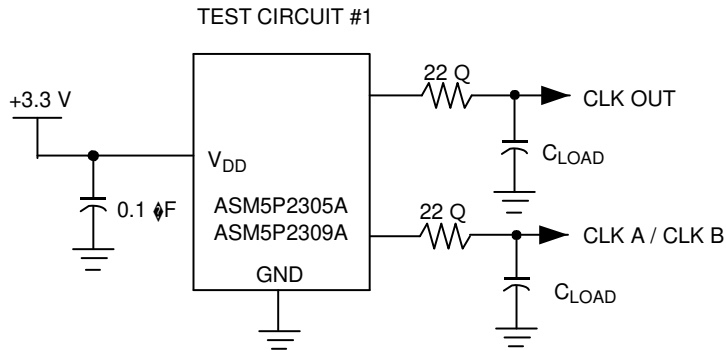

**Figure 3. Test Circuit**

# ASM5P2305A, ASM5P2309A

## Switching Waveforms

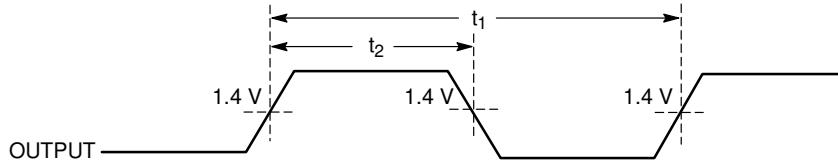

Figure 4. Duty Cycle Timing

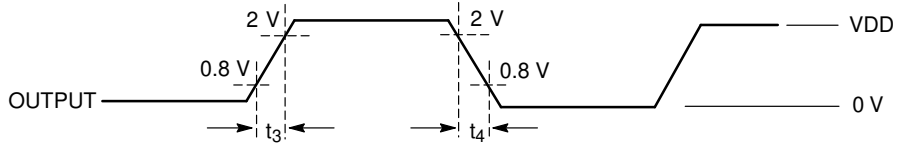

Figure 5. All Outputs Rise/Fall Time

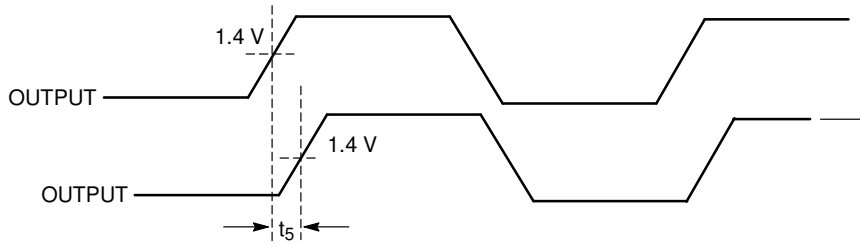

Figure 6. Output-Output Skew

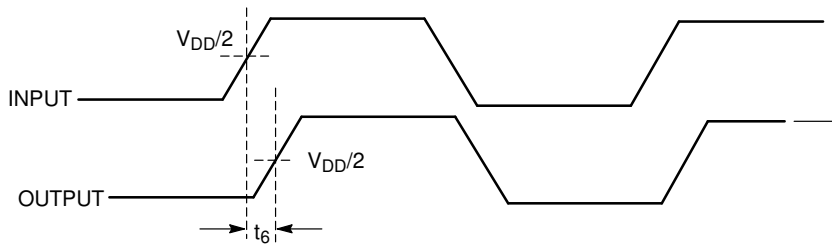

Figure 7. Input-Output Propagation Delay

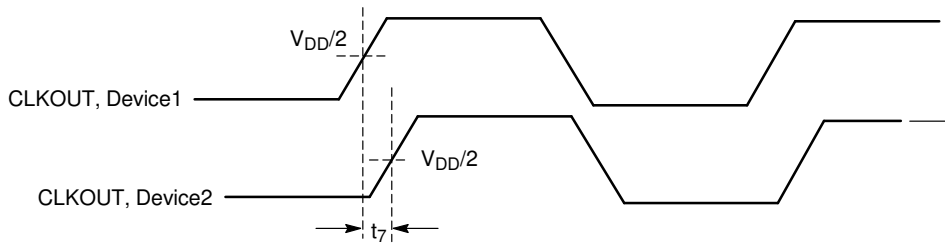
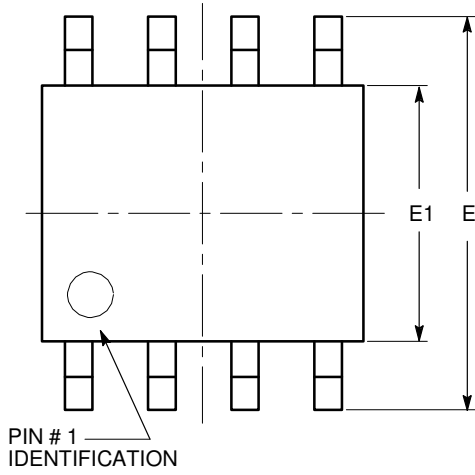

Figure 8. Device-Device Skew

# ASM5P2305A, ASM5P2309A

## PACKAGE DIMENSIONS

SOIC 8, 150 mils  
CASE 751BD-01  
ISSUE O



TOP VIEW

SYMBOL	MIN	NOM	MAX
A	1.35		1.75
A1	0.10		0.25
b	0.33		0.51
c	0.19		0.25
D	4.80		5.00
E	5.80		6.20
E1	3.80		4.00
e	1.27 BSC		
h	0.25		0.50
L	0.40		1.27
$\theta$	0°		8°

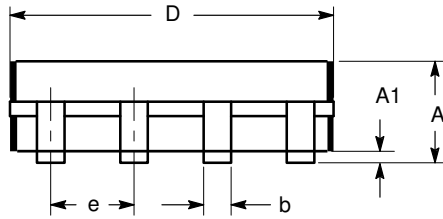

SIDE VIEW

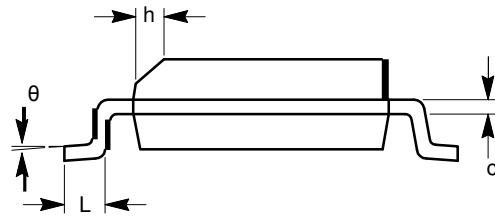

END VIEW

**Notes:**

- (1) All dimensions are in millimeters. Angles in degrees.
- (2) Complies with JEDEC MS-012.



# ASM5P2305A, ASM5P2309A

## PACKAGE DIMENSIONS

TSSOP8, 4.4x3  
CASE 948AL-01  
ISSUE O

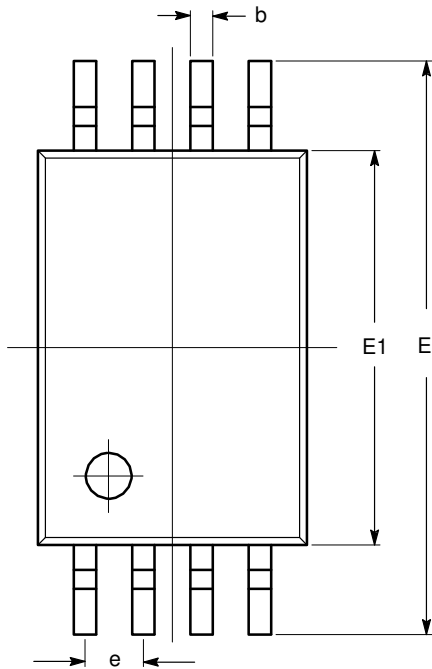

SYMBOL	MIN	NOM	MAX
A			1.20
A1	0.05		0.15
A2	0.80	0.90	1.05
b	0.19		0.30
c	0.09		0.20
D	2.90	3.00	3.10
E	6.30	6.40	6.50
E1	4.30	4.40	4.50
e	0.65 BSC		
L	1.00 REF		
L1	0.50	0.60	0.75
$\theta$	0°		8°

TOP VIEW

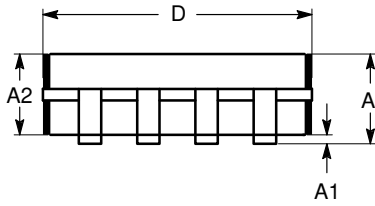

SIDE VIEW

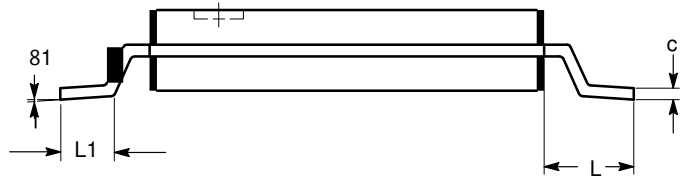

END VIEW

**Notes:**

- (1) All dimensions are in millimeters. Angles in degrees.
- (2) Complies with JEDEC MO-153.

# ASM5P2305A, ASM5P2309A

## PACKAGE DIMENSIONS

SOIC-16, 150 mils  
CASE 751BG-01  
ISSUE O

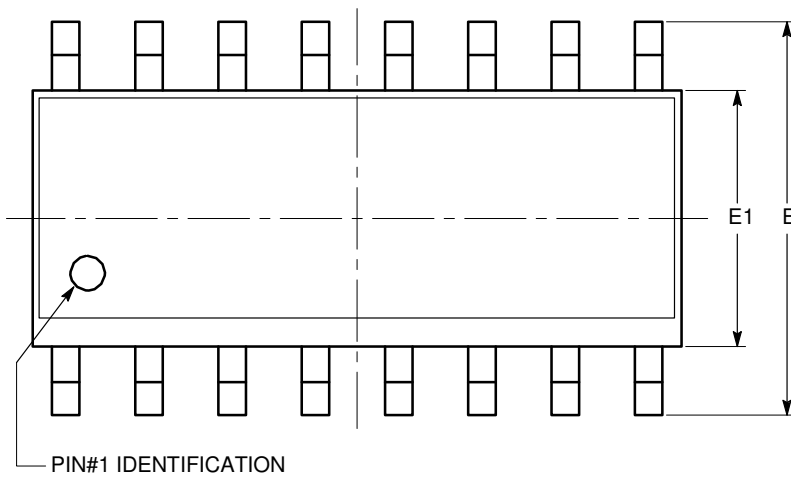

SYMBOL	MIN	NOM	MAX
A	1.35		1.75
A1	0.10		0.25
b	0.33		0.51
c	0.19		0.25
D	9.80	9.90	10.00
E	5.80	6.00	6.20
E1	3.80	3.90	4.00
e	1.27 BSC		
h	0.25		0.50
L	0.40		1.27
$\theta$	$0^\circ$		$8^\circ$

TOP VIEW

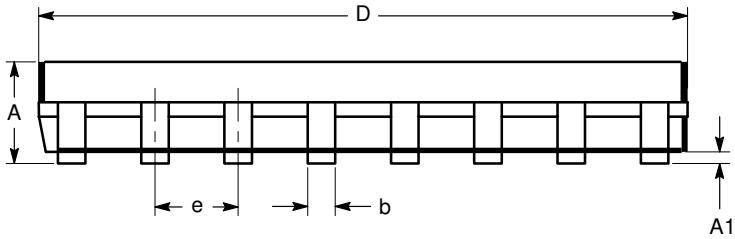

SIDE VIEW

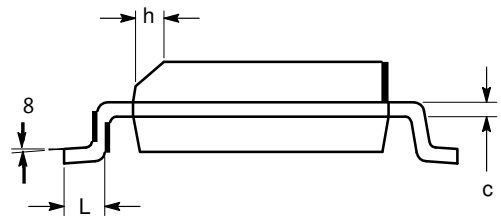

END VIEW

**Notes:**

- (1) All dimensions are in millimeters. Angles in degrees.
- (2) Complies with JEDEC MS-012.

# ASM5P2305A, ASM5P2309A

## PACKAGE DIMENSIONS

TSSOP16, 4.4x5  
CASE 948AN-01  
ISSUE O

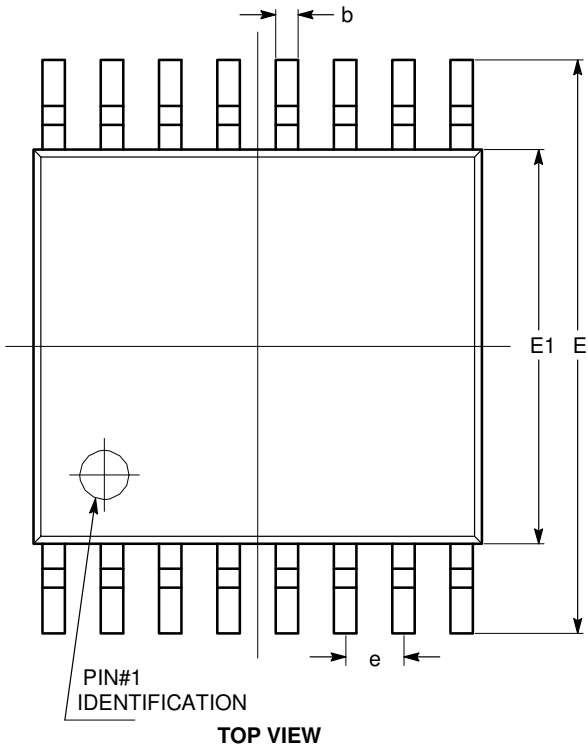

SYMBOL	MIN	NOM	MAX
A			1.10
A1	0.05		0.15
A2	0.85		0.95
b	0.19		0.30
c	0.13		0.20
D	4.90		5.10
E	6.30		6.50
E1	4.30		4.50
e	0.65 BSC		
L	1.00 REF		
L1	0.45		0.75
$\theta$	0°		8°

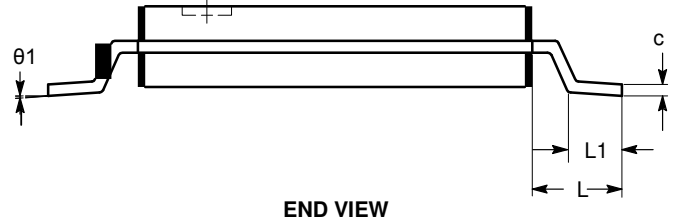
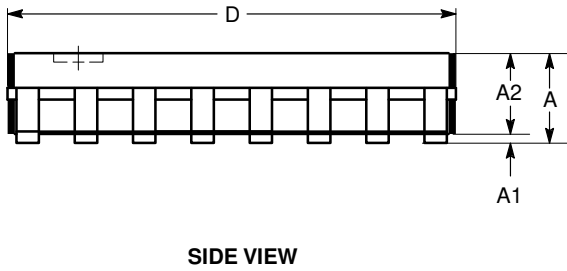

**Notes:**

- (1) All dimensions are in millimeters. Angles in degrees.
- (2) Complies with JEDEC MO-153.

## ASM5P2305A, ASM5P2309A

**Table 8. ORDERING INFORMATION**

Part Number	Marking	Package Type	Temperature
P5P2309AF-1-16ST	5P2309AF-1	16-pin 150-mil SOIC-TUBE,Pb Free	Commercial
P5I2309AF-1-16ST	5I2309AF-1	16-pin 150-mil SOIC-TUBE,Pb Free	Industrial
P5P2309AF-116SR	5P2309AF-1	16-pin 150-mil SOIC-TAPE & REEL,Pb Free	Commercial
P5I2309AF-116SR	5I2309AF-1	16-pin 150-mil SOIC-TAPE & REEL,Pb Free	Industrial
P5P2309AF-1-16TT	5P2309AF-1	16-pin 4.4-mm TSSOP - TUBE,Pb Free	Commercial
ASM5I2309AF-1-16-TT	5I2309AF-1	16-pin 4.4-mm TSSOP - TUBE,Pb Free	Industrial
P5P2309AF-1-16TR	5P2309AF-1	16-pin 4.4-mm TSSOP - TAPE & REEL,Pb Free	Commercial
ASM5I2309AF-1-16-TR	5I2309AF-1	16-pin 4.4-mm TSSOP - TAPE & REEL,Pb Free	Industrial
P5P2309AF-1H16ST	5P2309AF-1H	16-pin 150-mil SOIC-TUBE,Pb Free	Commercial
ASM5I2309AF-1H-16-ST	5I2309AF-1H	16-pin 150-mil SOIC-TUBE,Pb Free	Industrial
P5P2309AF-1H16SR	5P2309AF-1H	16-pin 150-mil SOIC-TAPE & REEL,Pb Free	Commercial
ASM5I2309AF-1H-16-SR	5I2309AF-1H	16-pin 150-mil SOIC-TAPE & REEL,Pb Free	Industrial
ASM5P2309AF-1H-16-TT	5P2309AF-1H	16-pin 4.4-mm TSSOP - TUBE,Pb Free	Commercial
ASM5I2309AF-1H-16-TT	5I2309AF-1H	16-pin 4.4-mm TSSOP - TUBE,Pb Free	Industrial
P5P2309AF-1H16TR	5P2309AF-1H	16-pin 4.4-mm TSSOP - TAPE & REEL,Pb Free	Commercial
ASM5I2309AF-1H-16-TR	5I2309AF-1H	16-pin 4.4-mm TSSOP - TAPE & REEL,Pb Free	Industrial
P5P2305AF-1-08ST	5P2305AF-1	8-pin 150-mil SOIC-TUBE,Pb Free	Commercial
P5I2305AF-108ST	5I2305AF-1	8-pin 150-mil SOIC-TUBE,Pb Free	Industrial
P5P2305AF-1-08SR	5P2305AF-1	8-pin 150-mil SOIC-TAPE & REEL,Pb Free	Commercial
ASM5I2305AF-1-08-SR	5I2305AF-1	8-pin 150-mil SOIC-TAPE & REEL,Pb Free	Industrial
ASM5P2305AF-1-08-TT	5P2305AF-1	8-pin 4.4-mm TSSOP - TUBE,Pb Free	Commercial
ASM5I2305AF-1-08-TT	5I2305AF-1	8-pin 4.4-mm TSSOP - TUBE,Pb Free	Industrial
ASM5P2305AF-1-08-TR	5P2305AF-1	8-pin 4.4-mm TSSOP - TAPE & REEL,Pb Free	Commercial
ASM5I2305AF-1-08-TR	5I2305AF-1	8-pin 4.4-mm TSSOP - TAPE & REEL,Pb Free	Industrial
ASM5P2305AF-1H-08-ST	5P2305AF-1H	8-pin 150-mil SOIC-TUBE,Pb Free	Commercial
P5I2305AF-1H08ST	5I2305AF-1H	8-pin 150-mil SOIC-TUBE,Pb Free	Industrial
P5P2305AF-1H08SR	5P2305AF-1H	8-pin 150-mil SOIC-TAPE & REEL,Pb Free	Commercial
P5I2305AF-1H08SR	5I2305AF-1H	8-pin 150-mil SOIC-TAPE & REEL,Pb Free	Industrial
ASM5P2305AF-1H-08-TT	5P2305AF-1H	8-pin 4.4-mm TSSOP - TUBE,Pb Free	Commercial
ASM5I2305AF-1H-08-TT	5I2305AF-1H	8-pin 4.4-mm TSSOP - TUBE,Pb Free	Industrial
P5P2305AF-1H08TR	5P2305AF-1H	8-pin 4.4-mm TSSOP - TAPE & REEL,Pb Free	Commercial
P5I2305AF-1H08TR	5I2305AF-1H	8-pin 4.4-mm TSSOP - TAPE & REEL,Pb Free	Industrial

# ASM5P2305A, ASM5P2309A

Pentium is a registered trademark of Intel Corporation.

**ON Semiconductor** and  are registered trademarks of Semiconductor Components Industries, LLC (SCILLC). SCILLC reserves the right to make changes without further notice to any products herein. SCILLC makes no warranty, representation or guarantee regarding the suitability of its products for any particular purpose, nor does SCILLC assume any liability arising out of the application or use of any product or circuit, and specifically disclaims any and all liability, including without limitation special, consequential or incidental damages. "Typical" parameters which may be provided in SCILLC data sheets and/or specifications can and do vary in different applications and actual performance may vary over time. All operating parameters, including "Typicals" must be validated for each customer application by customer's technical experts. SCILLC does not convey any license under its patent rights nor the rights of others. SCILLC products are not designed, intended, or authorized for use as components in systems intended for surgical implant into the body, or other applications intended to support or sustain life, or for any other application in which the failure of the SCILLC product could create a situation where personal injury or death may occur. Should Buyer purchase or use SCILLC products for any such unintended or unauthorized application, Buyer shall indemnify and hold SCILLC and its officers, employees, subsidiaries, affiliates, and distributors harmless against all claims, costs, damages, and expenses, and reasonable attorney fees arising out of, directly or indirectly, any claim of personal injury or death associated with such unintended or unauthorized use, even if such claim alleges that SCILLC was negligent regarding the design or manufacture of the part. SCILLC is an Equal Opportunity/Affirmative Action Employer. This literature is subject to all applicable copyright laws and is not for resale in any manner.

## PUBLICATION ORDERING INFORMATION

### LITERATURE FULFILLMENT:

Literature Distribution Center for ON Semiconductor  
P.O. Box 5163, Denver, Colorado 80217 USA  
**Phone:** 303-675-2175 or 800-344-3860 Toll Free USA/Canada  
**Fax:** 303-675-2176 or 800-344-3867 Toll Free USA/Canada  
**Email:** [orderlit@onsemi.com](mailto:orderlit@onsemi.com)

**N. American Technical Support:** 800-282-9855 Toll Free  
USA/Canada  
**Europe, Middle East and Africa Technical Support:**  
Phone: 421 33 790 2910  
**Japan Customer Focus Center**  
Phone: 81-3-5773-3850

**ON Semiconductor Website:** [www.onsemi.com](http://www.onsemi.com)

**Order Literature:** <http://www.onsemi.com/orderlit>

For additional information, please contact your local Sales Representative

**ASM5P2305A/D**