



Chipsmall Limited consists of a professional team with an average of over 10 year of expertise in the distribution of electronic components. Based in Hongkong, we have already established firm and mutual-benefit business relationships with customers from,Europe,America and south Asia,supplying obsolete and hard-to-find components to meet their specific needs.

With the principle of “Quality Parts,Customers Priority,Honest Operation,and Considerate Service”,our business mainly focus on the distribution of electronic components. Line cards we deal with include Microchip,ALPS,ROHM,Xilinx,Pulse,ON,Everlight and Freescale. Main products comprise IC,Modules,Potentiometer,IC Socket,Relay,Connector.Our parts cover such applications as commercial,industrial, and automotives areas.

We are looking forward to setting up business relationship with you and hope to provide you with the best service and solution. Let us make a better world for our industry!



## Contact us

Tel: +86-755-8981 8866 Fax: +86-755-8427 6832

Email & Skype: info@chipsmall.com Web: www.chipsmall.com

Address: A1208, Overseas Decoration Building, #122 Zhenhua RD., Futian, Shenzhen, China



NOTES: UNLESS OTHERWISE SPECIFIED.

1. ALL DIMENSIONS ARE IN mm.  
TOLERANCES TO BE  $\pm 0.25$  mm.
2. PARTS SPECIFIED AS FOLLOWS:

2-1. ENCLOSURE:

- \* MATERIAL: GE LEXAN 945,  
V-0 RATED FLAMMABILITY.
- \* COLOR: GE BLACK (BK1D097).
- \* TEXTURE: MT-11020 (MAT).

2-2. AC RECEPTACLE:

- \* IEC 320, C6 CERTIFIED, 3 WAY.
- \* COLOR: BLACK PER MAKER.

2-3. DC OUTPUT (FERRITE CORE):

- \* CONNECTOR: FORK TYPE WITH  
LOCK NOTCH.

DIELECTRIC: PANTONE XXX PBT RESIN.

- \* CORE: RH 11.5\*4.9\*25
- \* CABLE: UL AWM 1571,  
WIRE #20 & SPIRAL #20.
- \* JACKET COLOR: BLACK.

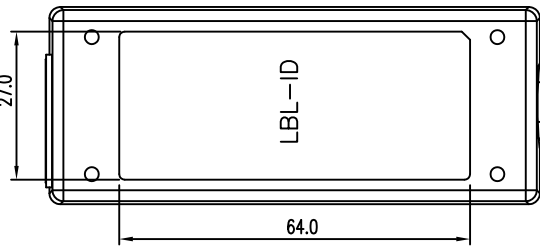
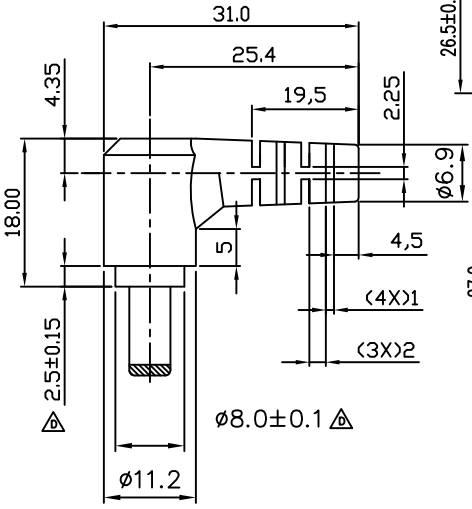
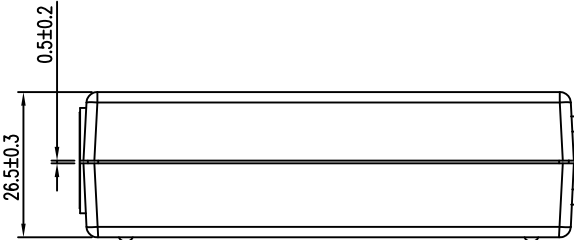
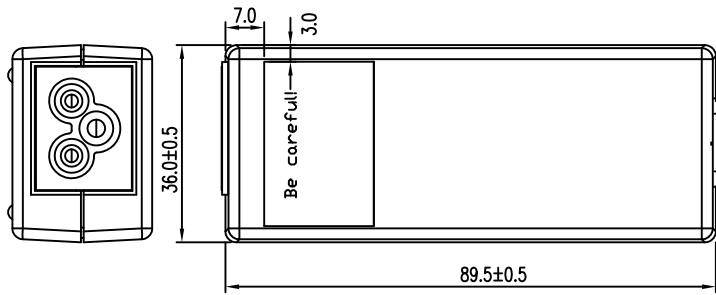
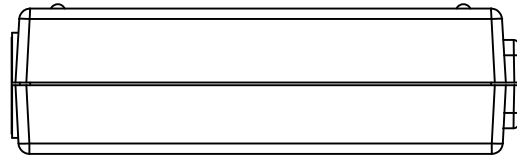

L=1800.0±25.0

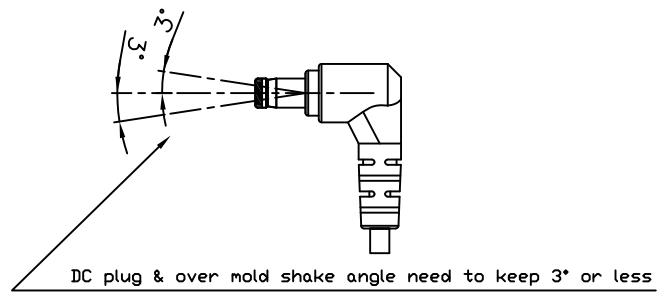
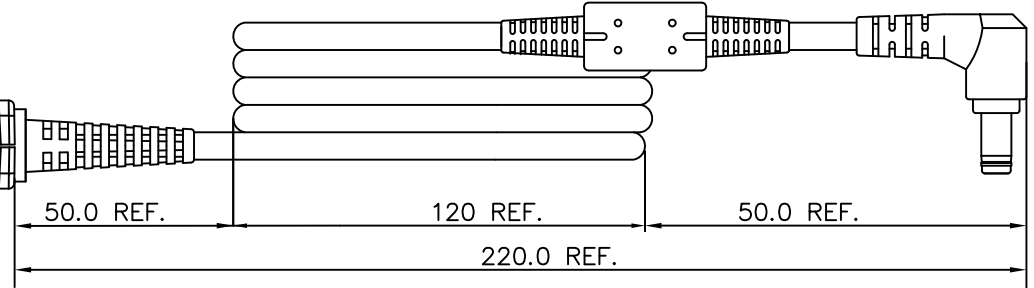
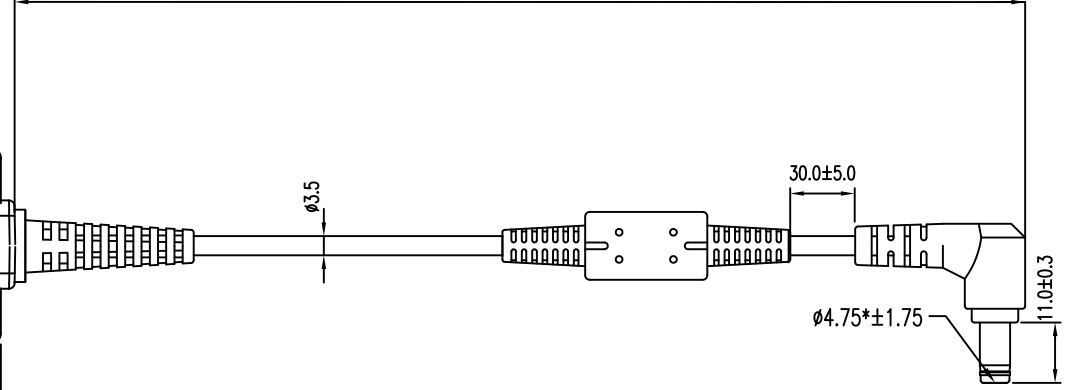

REVISION	RELEASED	14-AUG-2012	1A-8F	PRINTING DATE	13-AUG-2007	2D FILE	OUTLINE_PA-1300-04CO	DESIGNER	MIKA CHUANG	LITEON	TITLE: OUTLINE DRAW.	PART NO:	
	DESCRIPTION	DATE	ZONE	UNIT: mm	SCALE:	3D FILE		CHECKER		LITE-ON ELECTRONICS, INC.	PROJECT: PA-1300-04CO	DRAWING NO:	D-001387
								APPROVED					REV: A