



Chipsmall Limited consists of a professional team with an average of over 10 year of expertise in the distribution of electronic components. Based in Hongkong, we have already established firm and mutual-benefit business relationships with customers from,Europe,America and south Asia,supplying obsolete and hard-to-find components to meet their specific needs.

With the principle of “Quality Parts,Customers Priority,Honest Operation,and Considerate Service”,our business mainly focus on the distribution of electronic components. Line cards we deal with include Microchip,ALPS,ROHM,Xilinx,Pulse,ON,Everlight and Freescale. Main products comprise IC,Modules,Potentiometer,IC Socket,Relay,Connector.Our parts cover such applications as commercial,industrial, and automotives areas.

We are looking forward to setting up business relationship with you and hope to provide you with the best service and solution. Let us make a better world for our industry!



Contact us

Tel: +86-755-8981 8866 Fax: +86-755-8427 6832

Email & Skype: info@chipsmall.com Web: www.chipsmall.com

Address: A1208, Overseas Decoration Building, #122 Zhenhua RD., Futian, Shenzhen, China



Power Operational Amplifier

FEATURES

- High Internal Dissipation — 250 Watts
- High Voltage, High Current — 100V, 30A
- High Slew Rate — 100V/ μ s
- 4 Wire Current Limit Sensing
- Low Distortion
- External Shutdown Control
- Optional Boost Voltage Inputs
- Evaluation Kit — see EK09



APPLICATIONS

- Linear And Rotary Motor Drives
- Sonar Transducer Driver
- Yoke/magnetic Field Excitation
- Programmable Power Supplies To ± 45 V
- Audio up to 500W

DESCRIPTION

The PA05 is a high voltage MOSFET power operational amplifier that extends the performance limits of power amplifiers in slew rate and power bandwidth, while maintaining high current and power dissipation ratings.

The PA05 is a highly flexible amplifier. The shutdown control feature allows the output stage to be turned off for standby operation or load protection during fault conditions. Boost voltage inputs allow the small signal portion of the amplifier to operate at a higher voltage than the high current output stage. The amplifier is then biased to achieve close linear swings to the supply rails at high currents for extra efficient operation. External compensation tailors slew rate and bandwidth performance to user needs. A four wire sense technique allows precision current limiting without the need to consider internal or external milliohm parasitic resistance in the output line. The output stage is protected by thermal limiting circuits above junction temperatures of 175°C.

TYPICAL CONNECTION

Figure 1: Typical Connections

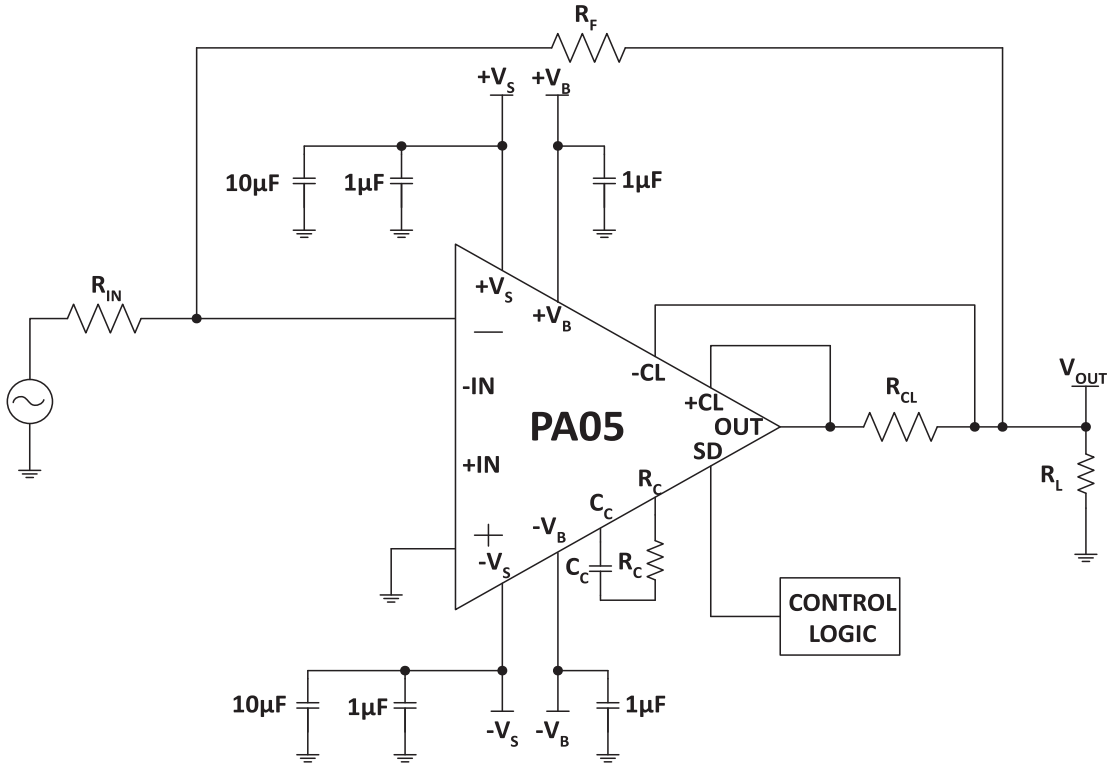

PINOUT AND DESCRIPTION TABLE

Figure 2: External Connections

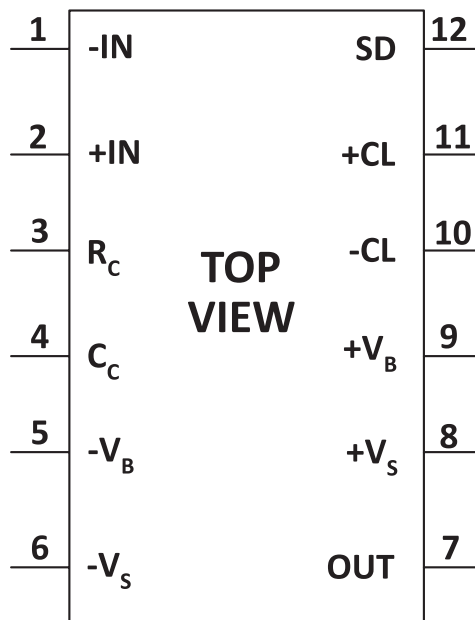

Pin Number	Name	Description
1	-IN	The inverting input.
2	+IN	The non-inverting input.
3	RC	Compensation resistor connection. Select value based on Phase Compensation. See applicable section.
4	CC	Compensation capacitor connection. Select value based on Phase Compensation. See applicable section.
5	-VB	The negative boost supply rail. Short to -Vs if unused. See applicable section.
6	-Vs	The negative supply rail.
7	OUT	The output. Connect this pin to load and to the feedback resistors through R_{CL} .
8	+Vs	The positive supply rail.
9	+VB	The positive boost supply rail. Short to +Vs if unused. See applicable section.
10	-CL	Connect to the load side of the current limit resistor. Current limit will activate as the voltage across R_{CL} increases.
11	+CL	Connect to the OUT side of the current limit resistor. Current limit will activate as the voltage across R_{CL} increases.
12	SD	The shutdown activation pin. See applicable section.

SPECIFICATIONS

Unless otherwise noted: $T_C = 25^\circ\text{C}$, $C_C = 470\text{pF}$, $R_C = 120\ \text{ohms}$. DC input specifications are \pm value given. Power supply voltage is typical rating. $\pm V_{\text{BOOST}} = \pm V_S$.

ABSOLUTE MAXIMUM RATINGS

Parameter	Symbol	Min	Max	Units
Supply Voltage, total	$+V_S$ to $-V_S$		100	V
Boost Voltage	$\pm V_B$	$-V_S - 20$	$+V_S + 20$	V
Output Current, continuous within SOA	I_O		30	A
Power Dissipation, internal	P_D		250	W
Input Voltage, differential	$V_{\text{IN (Diff)}}$	-20	20	V
Input Voltage, common mode	V_{cm}	$-V_B$	V_B	V
Temperature, pin solder, 10s			350	$^\circ\text{C}$
Temperature, junction ¹	T_J		175	$^\circ\text{C}$
Temperature, storage		-65	+150	$^\circ\text{C}$
Operating Temperature Range, case	T_C	-55	+125	$^\circ\text{C}$

1. Long term operation at the maximum junction temperature will result in reduced product life. Derate internal power dissipation to achieve high MTTF. For guidance, refer to the heatsink data sheet.

CAUTION

The PA05 is constructed from MOSFET transistors. ESD handling procedures must be observed. The internal substrate contains beryllia (BeO). Do not break the seal. If accidentally broken, do not crush, machine, or subject to temperatures in excess of 850°C to avoid generating toxic fumes.

INPUT

Parameter	Test Conditions	PA05			PA05A			Units
		Min	Typ	Max	Min	Typ	Max	
Offset Voltage, initial			5	10		2	5	mV
Offset Voltage vs. temperature	Full temp range		20	50		10	30	$\mu\text{V}/^\circ\text{C}$
Offset Voltage vs. supply			10	30		*	*	$\mu\text{V}/\text{V}$
Offset Voltage vs. power	Full temp range		30			10		$\mu\text{V}/\text{W}$
Bias Current, initial			10	50		5	20	μA
Bias Current vs. supply			0.01			*		$\mu\text{A}/\text{V}$
Offset Current, initial			10	50		5	20	μA
Input Impedance, DC			10^{11}			*		Ω
Input Capacitance			13			*		pF
Common Mode Voltage Range	Full temp range	$\pm V_B - 8$			*			V
Common Mode Rejection, DC	Full temp range, $V_{CM} = \pm 20\text{V}$	90	100		*	*		dB
Input Noise	100 kHz BW, $R_S = 1\text{ k}\Omega$		10			*		μVrms

GAIN

Parameter	Test Conditions	PA05			PA05A			Units
		Min	Typ	Max	Min	Typ	Max	
Open Loop, @ 15 Hz	Full temp range, $C_C = 82\text{pF}$	94	102		*	*		dB
Gain Bandwidth Product	$R_L = 10\ \Omega$		3			*		MHz
Power Bandwidth	$R_L = 4\ \Omega$, $V_O = 80\text{V}_{\text{p-p}}$, $A_V = -10$, $C_C = 82\text{pF}$, $R_C = 120\ \Omega$		400			*		kHz
Phase Margin	Full temp range, $C_C = 470\text{pF}$		60			*		$^\circ$

OUTPUT

Parameter	Test Conditions	PA05			PA05A			Units
		Min	Typ	Max	Min	Typ	Max	
Voltage Swing	$I_O = 20A$	$\pm V_S - 9.5$	$\pm V_S - 8.7$		*	*		V
Voltage Swing	$V_{BOOST} = V_S + 5V$, $I_O = 30A$	$\pm V_S - 5.8$	$\pm V_S - 5.0$		*	*		V
Current, peak		30			*			A
Settling Time to 0.1%	$A_V = +1$, 10V step, $R_L = 4 \Omega$		2.5			*		μs
Slew Rate	$A_V = -10$, $C_C = 82pF$, $R_C = 120 \Omega$	80	100		*	*		V/ μs
Capacitive Load	Full temp range, $A_V = +1$	2.2			*			nF
Resistance	$I_O = 0$, No load, 2 MHz		5			*		Ω
	$I_O = 1A$, 2 MHz		2			*		Ω

POWER SUPPLY

Parameter	Test Conditions	PA05			PA05A			Units
		Min	Typ	Max	Min	Typ	Max	
Voltage	Full temp range	± 15	± 45	± 50	*	*	*	V
Current, quiescent, boost supply			46	56		*	*	mA
Current, quiescent, total			90	120		*	*	mA
Current, quiescent, total, shut-down			46	56		*	*	mA

THERMAL

Parameter	Test Conditions	PA05			PA05A			Units
		Min	Typ	Max	Min	Typ	Max	
Resistance, AC, junction to case ¹	Full temp range, F>60 Hz		0.3	0.4		*	*	°C/W
Resistance, DC, junction to case	Full temp range, F<60 Hz		0.4	0.5		*	*	°C/W
Resistance, junction to air ²	Full temp range		12			*		°C/W
Temperature Range, case	Meets full range specs	-25		85	*		*	°C

1. Rating applies if the output current alternates between both output transistors at a rate faster than 60 Hz.
2. The PA05 must be used with a heatsink or the quiescent power may drive the unit to junction temperatures higher than 150°C.

Note: *The specification of PA05A is identical to the specification for PA05 in applicable column to the left.

TYPICAL PERFORMANCE GRAPHS

Figure 3: Power Derating

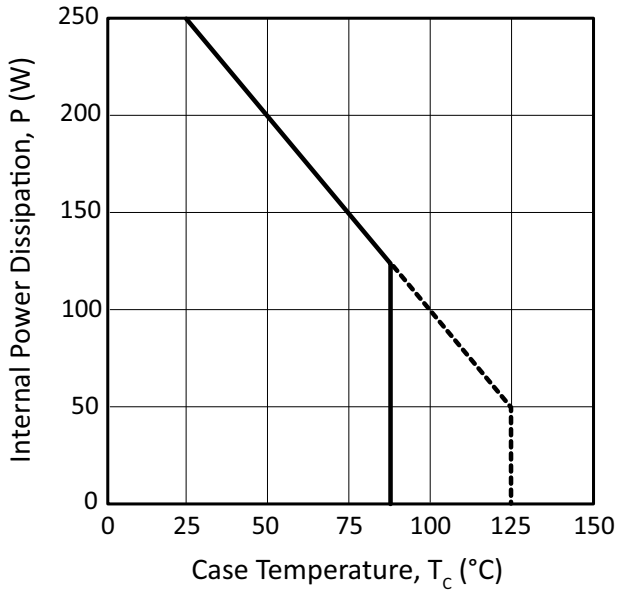

Figure 4: Power Supply Rejection

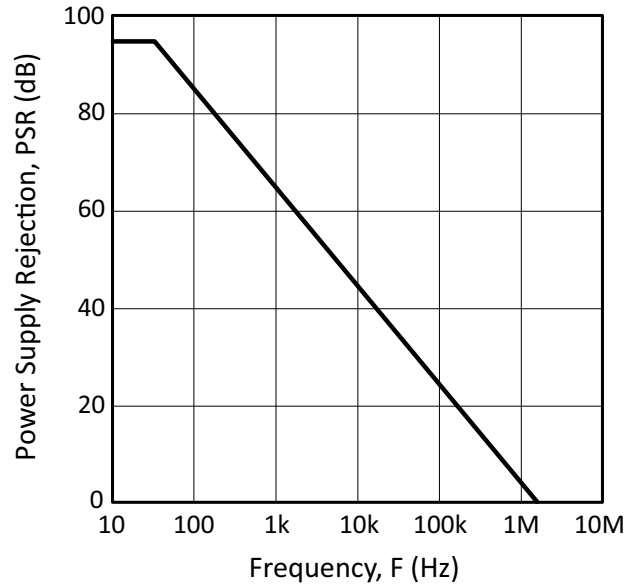

Figure 5: Small Signal Response

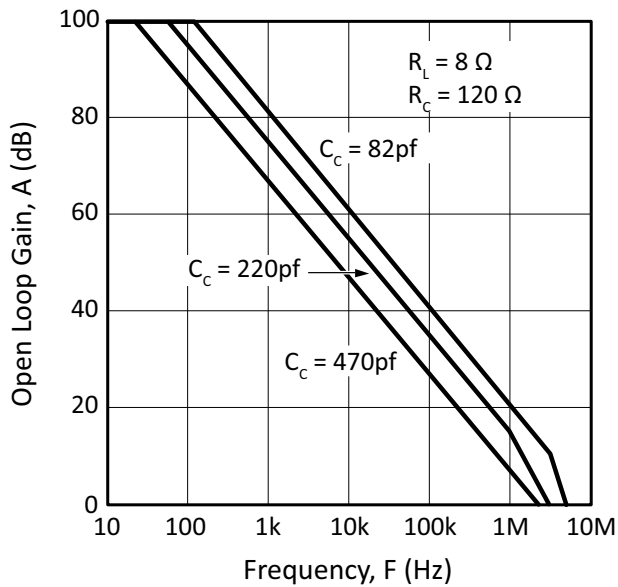

Figure 6: Phase Response

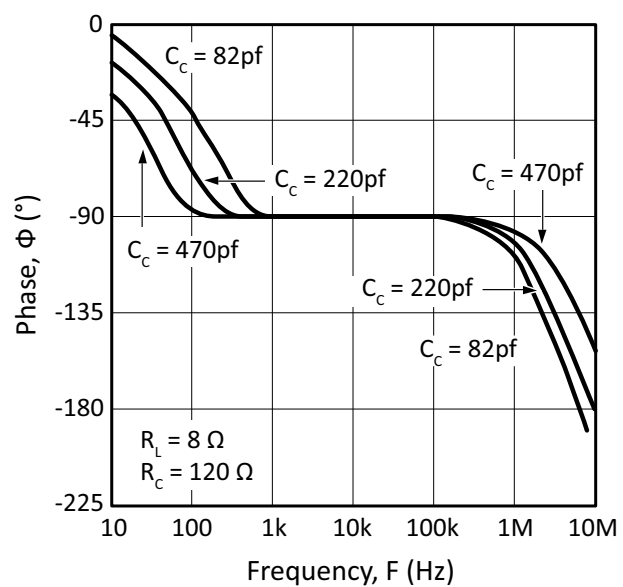

Figure 7: Slew Rate vs. Comp

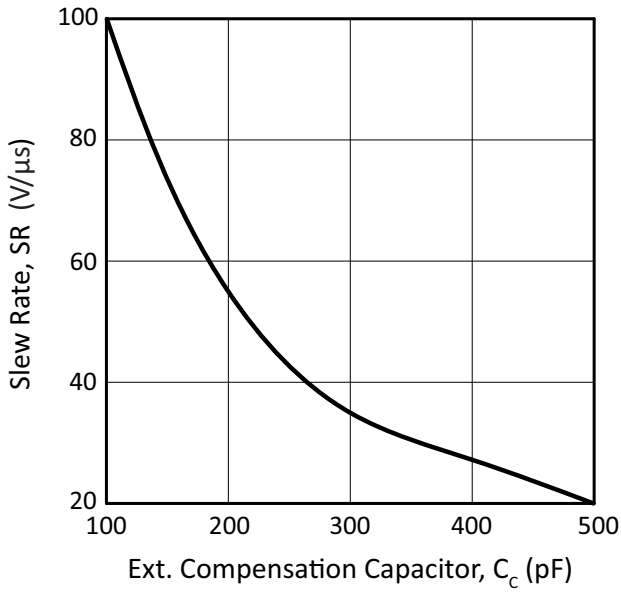

Figure 8: Output Voltage Swing

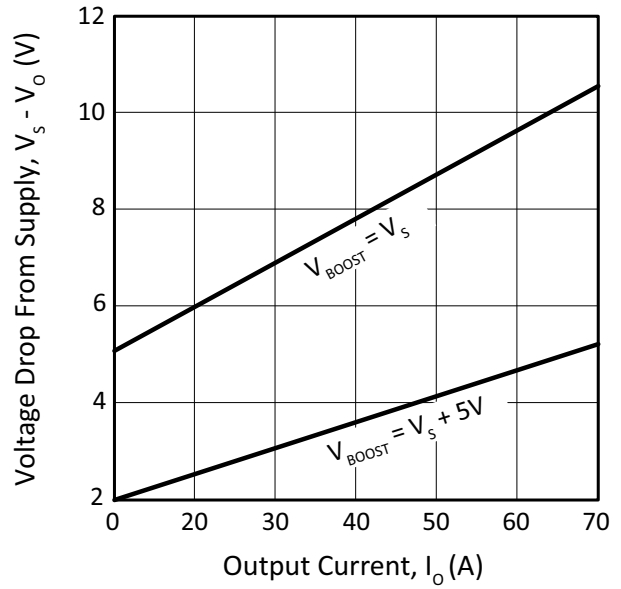

Figure 9: Common Mode Rejection

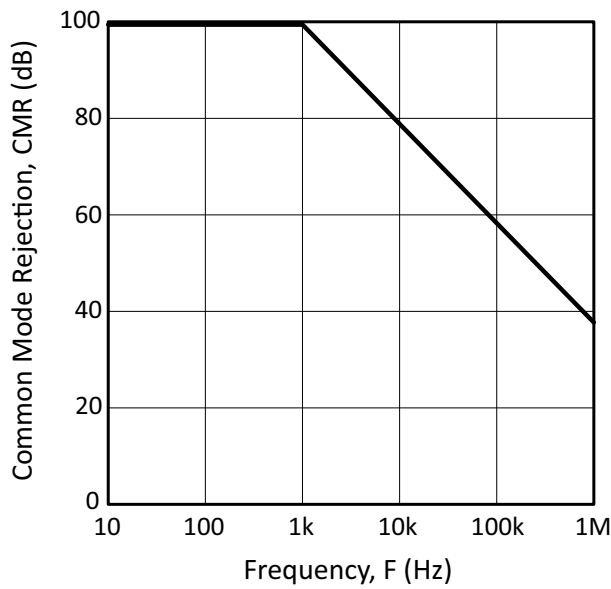

Figure 10: Pulse Response

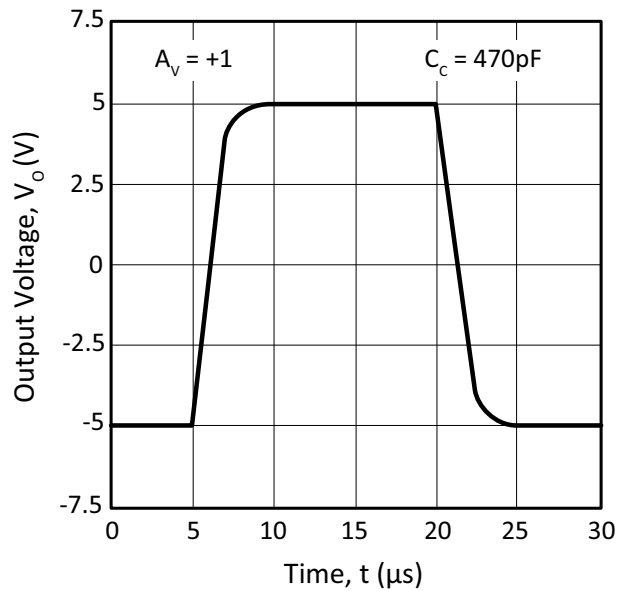

Figure 11: Current Limit

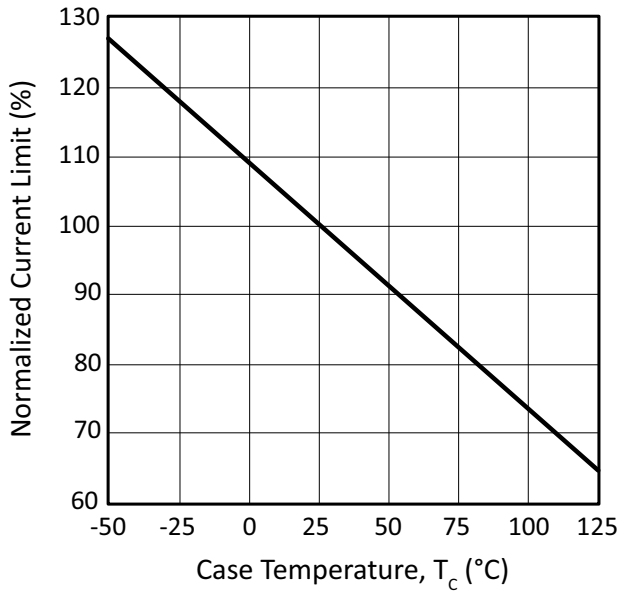

Figure 12: Harmonic Distortion

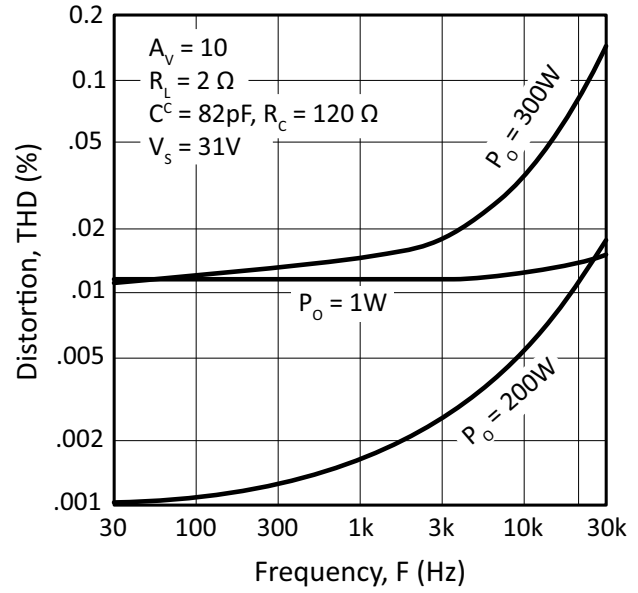

Figure 13: Quiescent Current

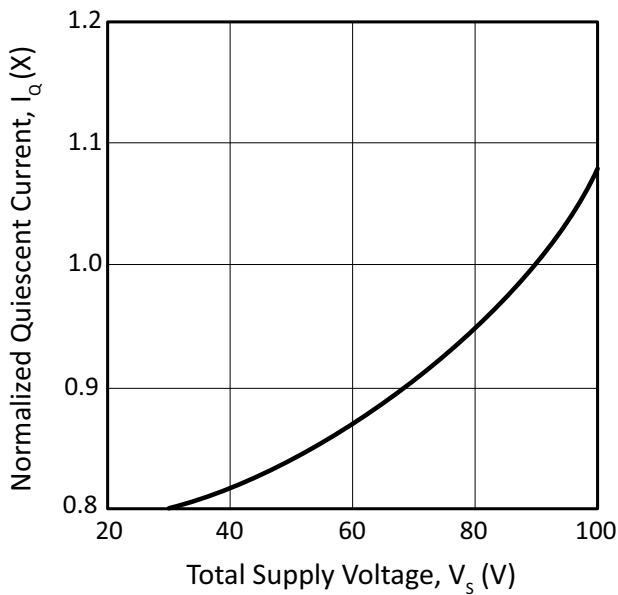
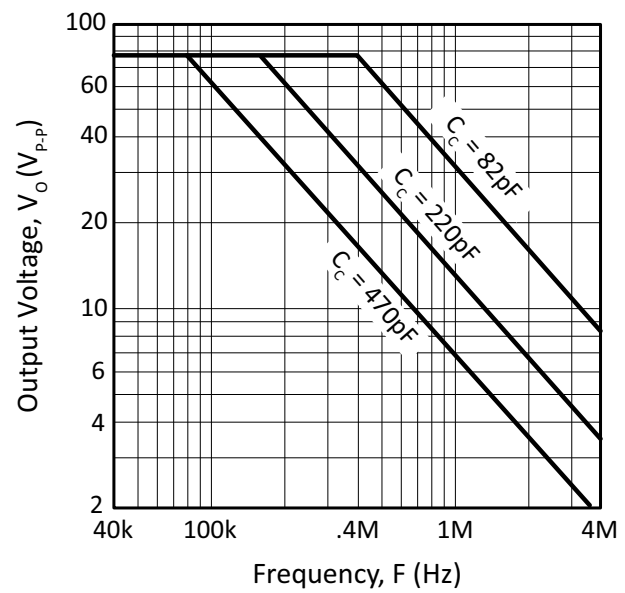

Figure 14: Power Response



SAFE OPERATING AREA (SOA)

The output stage thermal protection circuit engages when junction temperatures reach approximately 175°C. If the condition remains that caused the shutdown, the amplifier may oscillate in and out of shutdown, creating high peak power stresses reducing the reliability of the device.

The MOSFET output stage of this power operational amplifier has two distinct limitations:

1. The current handling capability of the MOSFET geometry and the wire bonds.
2. The junction temperature of the output MOSFETs.

Note: The output stage is protected against transient flyback. However, for protection against sustained, high energy flyback, external fast-recovery diodes should be used.

Figure 15: SOA

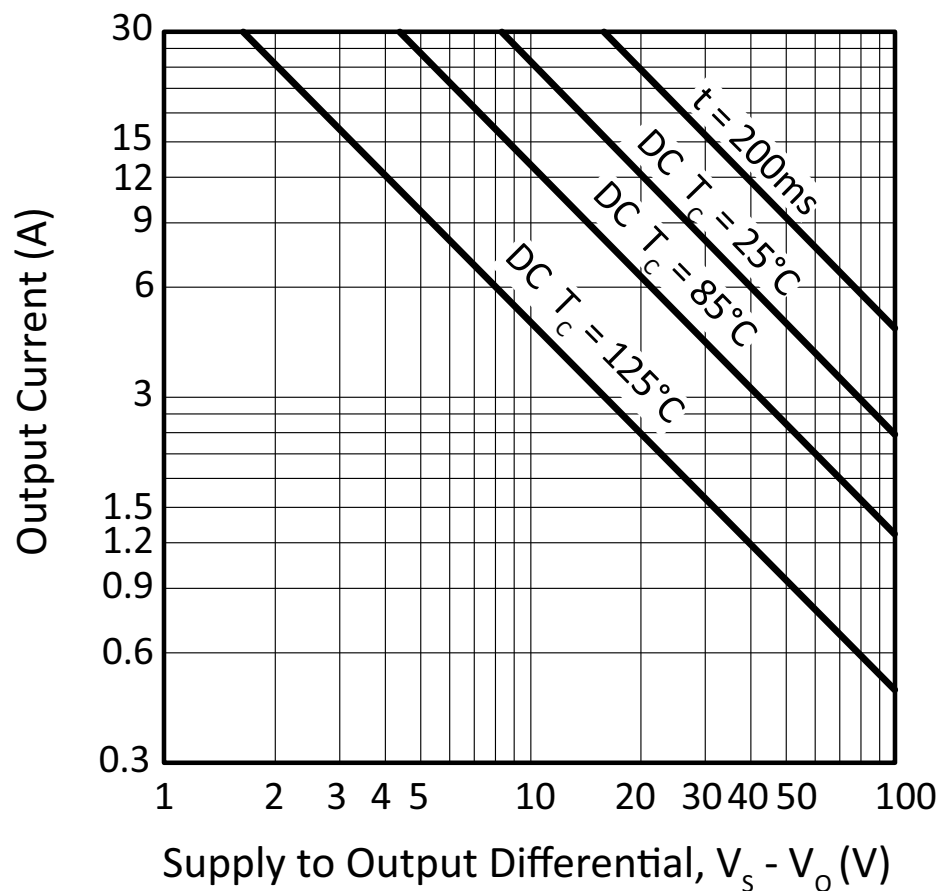

GENERAL

Please read Application Note 1 “General Operating Considerations” which covers stability, supplies, heat sinking, mounting, current limit, SOA interpretation, and specification interpretation. Visit www.apexanalog.com for Apex Microtechnology’s complete Application Notes library, Technical Seminar Workbook, and Evaluation Kits.

TYPICAL APPLICATION

The high power bandwidth of the PA05 allows driving sonar transducers via a resonant circuit including the transducer and a matching transformer. The load circuit appears resistive to the PA05. Control logic turns off the amplifier's output during shutdown.

Figure 16: Typical Application

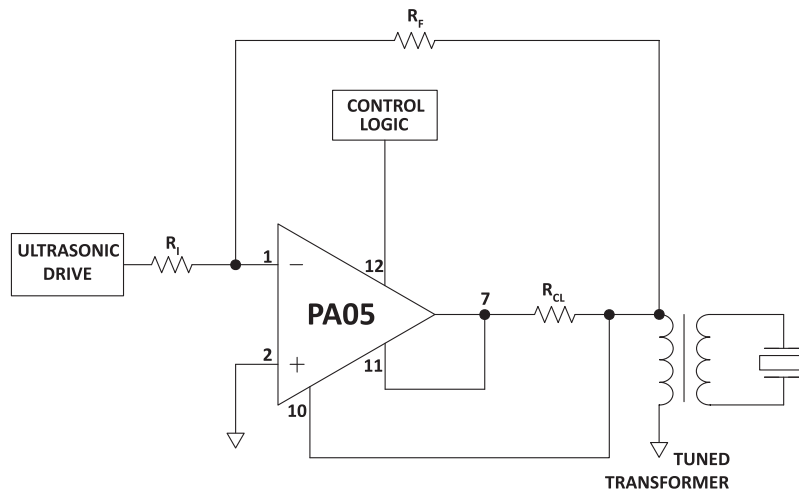

PHASE COMPENSATION

Gain	C_C^*	R_C
1	2470pF	120 Ω
>3	220pF	120 Ω
≥ 10	82pF	120 Ω

C_C rated for full supply voltage

*See Boost Operation paragraph.

CURRENT LIMIT

The two current limit sense lines are to be connected directly across the current limit sense resistor. For the current limit to work correctly, pin 11 must be connected to the amplifier output side and pin 10 connected to the load side of the current limit resistor, R_{CL} , as shown in Figure 17. This connection will bypass any parasitic resistances, R_p formed by sockets and solder joints as well as internal amplifier losses. The current limiting resistor may not be placed anywhere in the output circuit except where shown in Figure 17. If current limiting is not used, pins 10 and 11 must be tied to pin 7.

The value of the current limit resistor can be calculated as follows:

$$R_{CL}(\Omega) = \frac{0.7V}{I_{LIMIT}(A)}$$

Figure 17: Current Limit

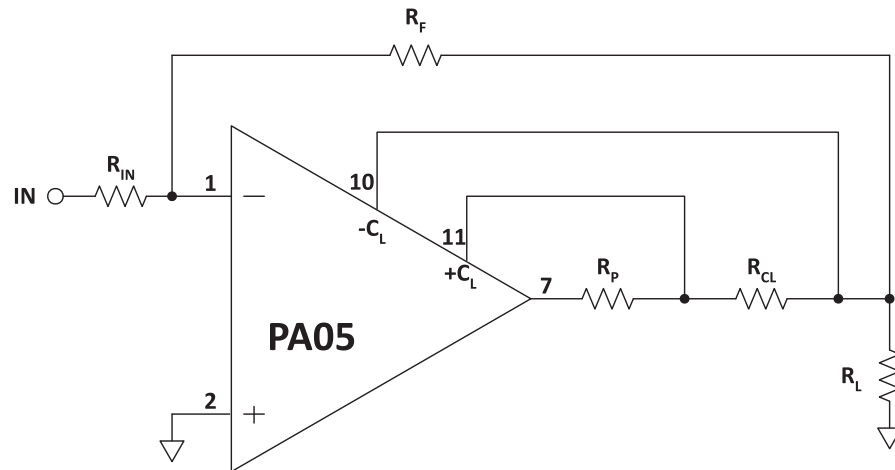

SHUTDOWN OPERATION

To disable the output stage, pin 12 is connected to ground via relay contacts or via an electronic switch. The switching device must be capable of sinking 2mA to complete shutdown and capable of standing off the supply voltage $+V_S$. See Figure 18 for suggested circuits.

From an internal circuitry standpoint, shutdown is just a special case of current limit where the allowed output current is zero. As with current limit, however, a small current does flow in the output during shutdown. A load impedance of 100 ohms or less is required to insure the output transistors are turned off. Note that even though the output transistors are off the output pin is not open circuited because of the shutdown operating current.

Figure 18: Shutdown Operation

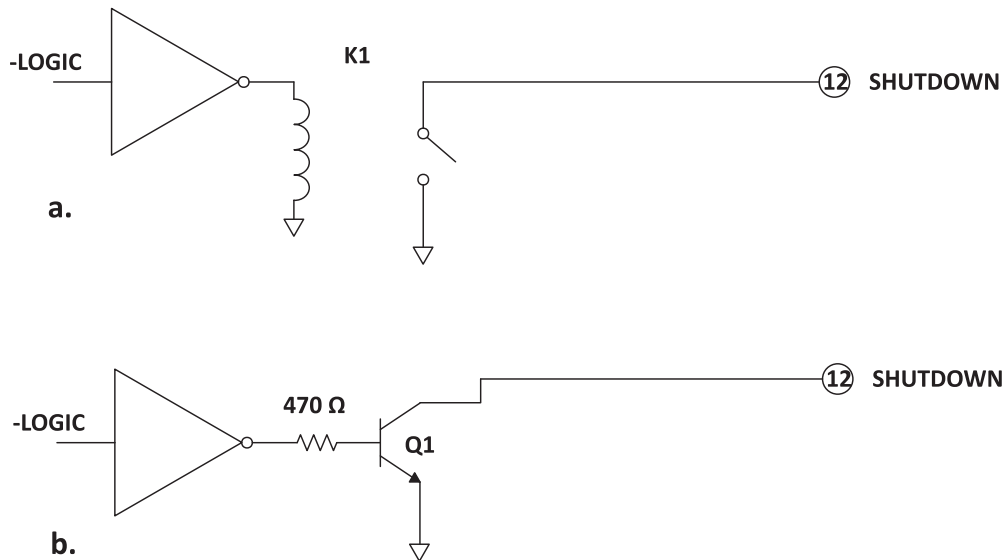

BOOST OPERATION

With the V_{BOOST} feature, the small signal stages of the amplifier are operated at higher supply voltages than the amplifier's high current output stage. $+V_{BOOST}$ (pin 9), and $-V_{BOOST}$ (pin 5) are connected to the small signal circuitry of the amplifier. $+V_S$ (pin 8) and $-V_S$ (pin 6) are connected to the high current output stage. An additional 5V on the V_{BOOST} pins is sufficient to allow the small signal stages to drive the output transistors into saturation and improve the output voltage swing for extra efficient operation when required. When close swings to the supply rails is not required, the $+V_{BOOST}$ and $+V_S$ pins must be strapped together as well as the $-V_{BOOST}$ and $-V_S$ pins. The V_{BOOST} pins must not be at a voltage lower than the V_S pins.

COMPENSATION

The external compensation components C_C and R_C are connected to pins 3 and 4. Unity gain stability can be achieved at any compensation capacitance greater than 470 pF with at least 60 degrees of phase margin. At higher gains, more phase shift can be tolerated in most designs and the compensation capacitance can accordingly be reduced, resulting in higher bandwidth and slew rate. Use the typical operating curves as a guide to select C_C and R_C for the application.

PACKAGE DESIGN

PACKAGE STYLE CR

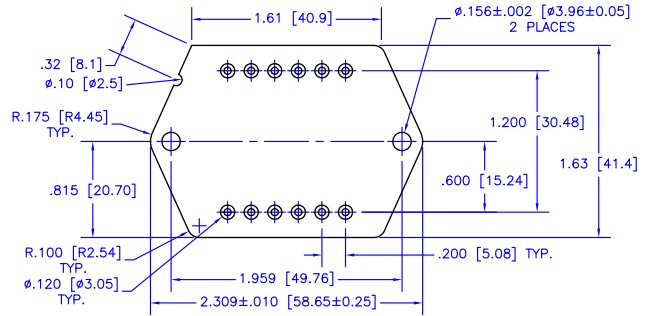
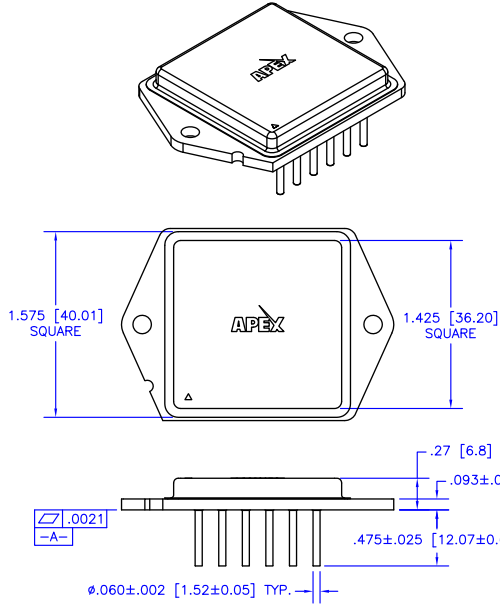

NOTES:

1. Dimensions are in inches & [mm].
2. Triangle on lid and notch in header denote pin 1.
3. Header material: Nickel-plated CRS
4. Lid material: Solid nickel
5. Pin material: Solderable nickel-plated Alloy 52
6. Welded hermetic package seal
7. Isolation: 1000 VDC any pin to case
8. Package weight: 1.87 oz [53 g]

NEED TECHNICAL HELP? CONTACT APEX SUPPORT!

For all Apex Microtechnology product questions and inquiries, call toll free 800-546-2739 in North America. For inquiries via email, please contact apex.support@apexanalog.com. International customers can also request support by contacting their local Apex Microtechnology Sales Representative. To find the one nearest to you, go to www.apexanalog.com

IMPORTANT NOTICE

Apex Microtechnology, Inc. has made every effort to insure the accuracy of the content contained in this document. However, the information is subject to change without notice and is provided "AS IS" without warranty of any kind (expressed or implied). Apex Microtechnology reserves the right to make changes without further notice to any specifications or products mentioned herein to improve reliability. This document is the property of Apex Microtechnology and by furnishing this information, Apex Microtechnology grants no license, expressed or implied under any patents, mask work rights, copyrights, trademarks, trade secrets or other intellectual property rights. Apex Microtechnology owns the copyrights associated with the information contained herein and gives consent for copies to be made of the information only for use within your organization with respect to Apex Microtechnology integrated circuits or other products of Apex Microtechnology. This consent does not extend to other copying such as copying for general distribution, advertising or promotional purposes, or for creating any work for resale.

APEX MICROTECHNOLOGY PRODUCTS ARE NOT DESIGNED, AUTHORIZED OR WARRANTED TO BE SUITABLE FOR USE IN PRODUCTS USED FOR LIFE SUPPORT, AUTOMOTIVE SAFETY, SECURITY DEVICES, OR OTHER CRITICAL APPLICATIONS. PRODUCTS IN SUCH APPLICATIONS ARE UNDERSTOOD TO BE FULLY AT THE CUSTOMER OR THE CUSTOMER'S RISK.

Apex Microtechnology, Apex and Apex Precision Power are trademarks of Apex Microtechnology, Inc. All other corporate names noted herein may be trademarks of their respective holders.