



Chipsmall Limited consists of a professional team with an average of over 10 year of expertise in the distribution of electronic components. Based in Hongkong, we have already established firm and mutual-benefit business relationships with customers from,Europe,America and south Asia,supplying obsolete and hard-to-find components to meet their specific needs.

With the principle of “Quality Parts,Customers Priority,Honest Operation,and Considerate Service”,our business mainly focus on the distribution of electronic components. Line cards we deal with include Microchip,ALPS,ROHM,Xilinx,Pulse,ON,Everlight and Freescale. Main products comprise IC,Modules,Potentiometer,IC Socket,Relay,Connector.Our parts cover such applications as commercial,industrial, and automotives areas.

We are looking forward to setting up business relationship with you and hope to provide you with the best service and solution. Let us make a better world for our industry!



Contact us

Tel: +86-755-8981 8866 Fax: +86-755-8427 6832

Email & Skype: info@chipsmall.com Web: www.chipsmall.com







Address: A1208, Overseas Decoration Building, #122 Zhenhua RD., Futian, Shenzhen, China

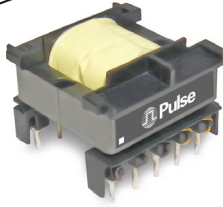

HIGH FREQUENCY WIRE WOUND TRANSFORMERS

EF25 Platforms - THT Horizontal



-  AC/DC and DC/DC Switching Transformers
-  Reinforced Insulation
-  3000 Vrms Hi-pot
-  Height: 20.8mm Max
-  Footprint: 29.2mm x 27.9mm Max
-  Topology: Flyback

Electrical Specifications @ 25°C — Operating Temperature -40°C to 130°C⁵

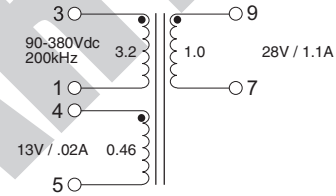
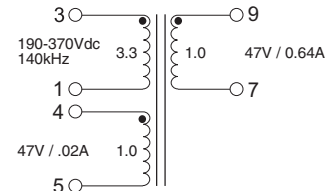
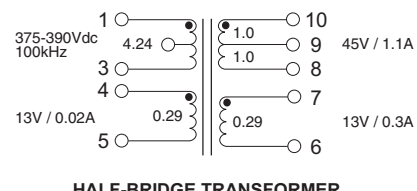
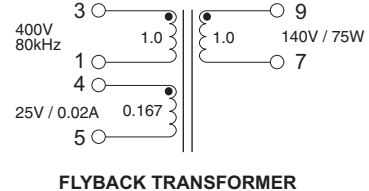
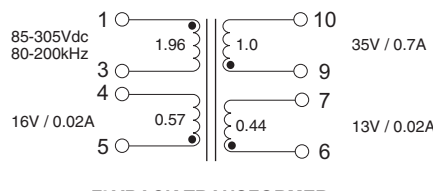
PA1297NL	Pri. Inductance	(3-1)	380µH ±10%	 <p>FLYBACK TRANSFORMER</p>
	Lk. Inductance	(3-1) with (7-9) shorted	11µH MAX	
	DCR	(3-1)	945mΩ MAX	
		(9-7)	40mΩ MAX	
		(4-5)	85mΩ MAX	
	Hi-Pot	Pri-Sec	3000Vrms	
K1 Factor	1528.3			
PA2547NL	Pri. Inductance	(3-1)	1850µH ±15%	 <p>FLYBACK TRANSFORMER</p>
	Lk. Inductance	(3-1) with (7-9) shorted	21µH MAX	
	DCR	(3-1)	930mΩ MAX	
		(9-7)	223mΩ MAX	
		(4-5)	408mΩ MAX	
	Hi-Pot	Pri-Sec	3000Vrms	
K1 Factor	4152.8			
PA2611NL	Pri. Inductance	1-3	9850µH ±15%	 <p>HALF-BRIDGE TRANSFORMER</p>
	Lk. Inductance	(1-3) with (6,7,8,9,10) shorted	40µH MAX	
	DCR	(1-3)	790mΩ MAX	
		(10-8)	220mΩ MAX	
		(7-6)	15mΩ MAX	
		(4-5)	80mΩ MAX	
Hi-Pot	Pri-Sec	3000Vrms		
K1 Factor	2.7			
PA2676NL	Pri. Inductance	(3-1)	860µH ±15%	 <p>FLYBACK TRANSFORMER</p>
	Lk. Inductance	(3-1) with (7-9) shorted	78µH MAX	
	DCR	(3-1)	910mΩ MAX	
		(9-7)	3050mΩ MAX	
		(4-5)	350mΩ MAX	
	Hi-Pot	Pri-Sec	4000Vrms	
K1 Factor	1537.3			
PA2804NL	Pri. Inductance	(1-3)	275µH ±10%	 <p>FLYBACK TRANSFORMER</p>
	Lk. Inductance	(1-3) with (4,5,6,7,8,9,10) shorted	8.4µH MAX	
	DCR	(1-3)	250mΩ MAX	
		(9-10)	160mΩ MAX	
		(5-4)	400mΩ MAX	
		(6-7)	311mΩ MAX	
Hi-Pot	Pri-Sec	3000Vrms		
K1 Factor	1179.8			

HIGH FREQUENCY WIRE WOUND TRANSFORMERS

EF25 Platforms - THT Vertical



Notes

1. The temperature of the component (ambient plus temperature rise) must be within the stated operating temperature range.
2. The above transformers and inductors have been tested and approved by Pulse's power IC partners and are sited in the appropriate datasheet or evaluation board documentation at these companies. To determine which IC and IC partners are matched with the above Pulse part numbers please consult the IC Cross Reference on the Pulse website.
3. For flyback topology applications, it is necessary to ensure that the transformer will not saturate in the application. The peak flux density (Bpk) should remain below 2700Gauss. To calculate the peak flux density use the following formula:

$$B_{pk} \text{ (Gauss)} = K1_Factor * I_{pk}(A)$$
4. In high volt-µsec applications, it is important to calculate the core loss of the transformer. Approximate transformer core loss can be calculated as:

$$CoreLoss \text{ (W)} = 3.9E-13 * (Freq_kHz)^{1.63} * (\Delta B_Gauss)^{2.63}$$
 where ΔB can be calculated as:
 For Flyback Topology: $\Delta B = K1_Factor * \Delta(A)$
 For Forward Topology: $\Delta B = K1_Factor * Volt\text{-}\mu sec$
5. The "NL" suffix indicates an RoHS-compliant part number. Non-NL suffix parts are not necessarily RoHS compliant, but are electrically and mechanically equivalent to NL versions. If a part number does not have the "NL" suffix, but an RoHS compliant version is required, please contact Pulse for availability.

Mechanical

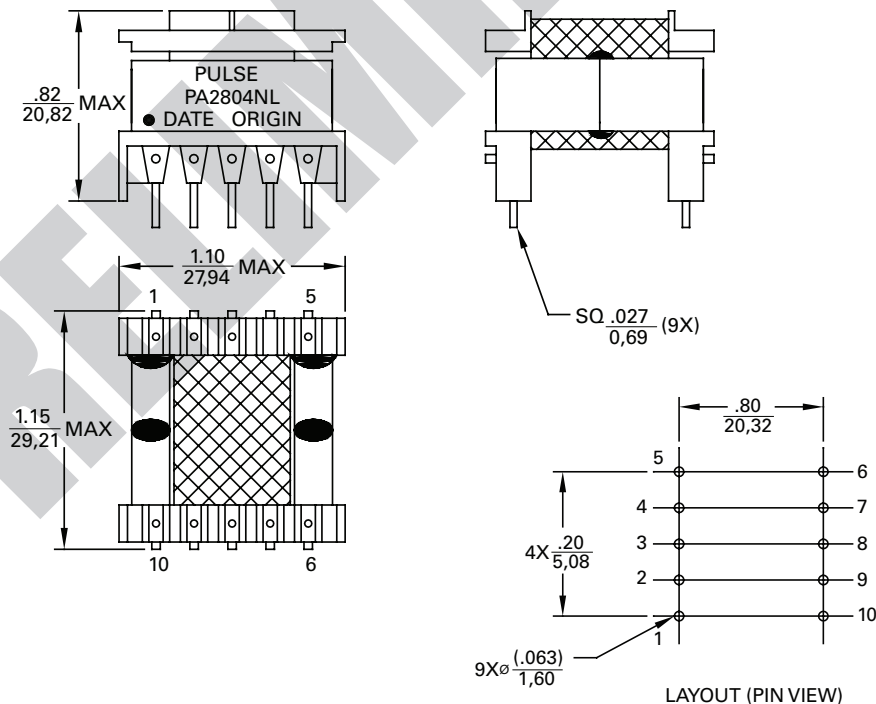

For More Information:

Pulse Worldwide Headquarters	Pulse Europe	Pulse China Headquarters	Pulse North China	Pulse South Asia	Pulse North Asia
12220 World Trade Dr. San Diego, CA 92128 U.S.A.	Einsteinstrasse 1 D-71083 Herrenberg Germany	B402, Shenzhen Academy of Aerospace Technology Bldg. 10th Kejinan Rd. High-Tech Zone Nanshan District Shenzhen, PR China 518057	Room 1503 XinYin Building No. 888 YiShan Rd. Shanghai 200233 China	135 Joo Seng Rd. #03-02 PM Industrial Bldg. Singapore 368363	No. 26, Kao Ching Rd. Yang Mei Chen Taoyuan Hsien Taiwan R. O. C.
www.pulseeng.com Tel: 858 674 8100 Fax: 858 674 8262	Tel: 49 7032 7806 0 Fax: 49 7032 7806 135	TEL: 86 755 33966678 FAX: 86 755 33966700	Tel: 86 21 54643211/2 Fax: 86 21 54643210	TEL: 65 6287 8998 FAX: 65 6280 0080	Tel: 886 3 4643715 Fax: 886 3 4641911

Performance warranty of products offered on this data sheet is limited to the parameters specified. Data is subject to change without notice. Other brand and product names mentioned herein may be trademarks or registered trademarks of their respective owners.
 © Copyright, 2009. Pulse Engineering, Inc. All rights reserved.