



Chipsmall Limited consists of a professional team with an average of over 10 year of expertise in the distribution of electronic components. Based in Hongkong, we have already established firm and mutual-benefit business relationships with customers from,Europe,America and south Asia,supplying obsolete and hard-to-find components to meet their specific needs.

With the principle of “Quality Parts,Customers Priority,Honest Operation,and Considerate Service”,our business mainly focus on the distribution of electronic components. Line cards we deal with include Microchip,ALPS,ROHM,Xilinx,Pulse,ON,Everlight and Freescale. Main products comprise IC,Modules,Potentiometer,IC Socket,Relay,Connector.Our parts cover such applications as commercial,industrial, and automotives areas.

We are looking forward to setting up business relationship with you and hope to provide you with the best service and solution. Let us make a better world for our industry!



## Contact us

Tel: +86-755-8981 8866 Fax: +86-755-8427 6832

Email & Skype: info@chipsmall.com Web: www.chipsmall.com

Address: A1208, Overseas Decoration Building, #122 Zhenhua RD., Futian, Shenzhen, China



**FEATURES**

- RoHS COMPLIANT
- LOW COST
- WIDE BANDWIDTH - 1.1 Mhz
- HIGH OUTPUT CURRENT - 1A per amplifier
- WIDE COMMON MODE RANGE Includes negative supply
- WIDE SUPPLY VOLTAGE RANGE Single supply: 5V to 40V Split supplies:  $\pm 2.5V$  to  $\pm 20V$
- LOW QUIESCIENT CURRENT
- VERY LOW DISTORTION

**APPLICATIONS**

- HALF AND FULL BRIDGE MOTOR DRIVERS
- AUDIO POWER AMPLIFIER
  - Stereo - 15.91W RMS per channel
  - Bridge - 31.82W RMS per 2 channels
- IDEAL FOR SINGLE SUPPLY SYSTEMS
  - 5V - Peripherals
  - 12V - Automotive
  - 28V - Avionic

**PACKAGING OPTIONS**

- 20-Pin PSOP, JEDEC MO-166-AB (PA60DK)
- 12-Pin Molded Plastic SIP (PA60EU)

**DESCRIPTION**

The amplifier design is a dual power op amp on a single monolithic die. This approach provides a cost-effective solution to applications where multiple amplifiers are required or a bridge configuration is needed. Very low harmonic distortion of 0.02% THD and low  $I_Q$  makes the PA60 a good solution for low power audio applications such as laptops and computer speakers.

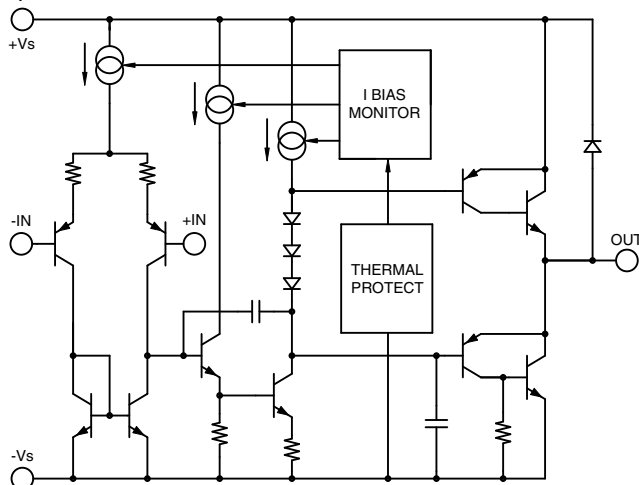

**FIGURE 1.** Equivalent schematic (one channel)

The dual output PA60 is available in two industry-standard packages. The through hole version of the PA60, the PA60EU, is available in a 12-Pin Molded Plastic SIP with standard 100



**12-PIN SIP PACKAGE STYLE EU**



**20-PIN PSOP PACKAGE STYLE DK**

mil spacing. The heat tab of EU package is tied to -VS. The surface mount version of the PA60, the PA60DK, is available in a 20-Pin PSOP, JEDEC MO-166-AB package. The heat slug of the DK package is tied to -VS.

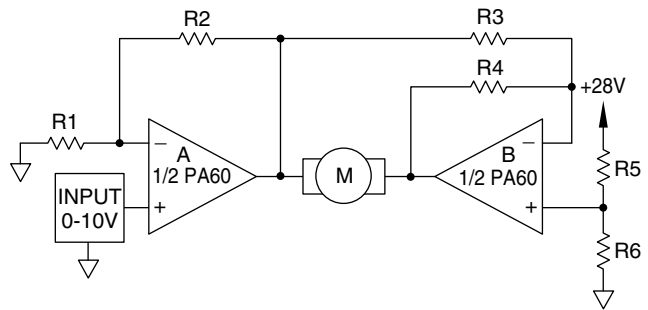
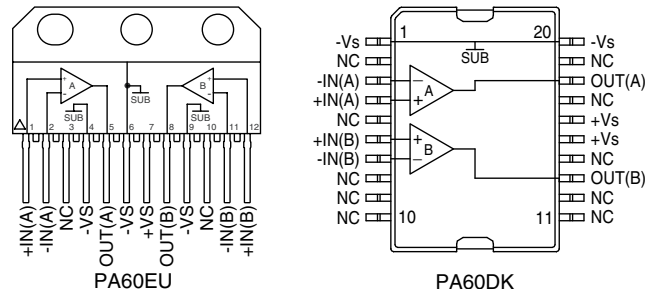

**FIGURE 2.** Bi-directional speed control from a single supply

**TYPICAL APPLICATION**

R1 and R2 set up Amplifier A as non-inverting. Amplifier B is set up as a unity gain inverter driven from the output of Amplifier A. Note that Amplifier B inverts the signals about the reference node, which is set at mid-supply by R5 and R6. When the command input is midrange, so is the output of Amplifier A. Since this is also equivalent to the reference node voltage, the output of Amplifier B is the same resulting in 0V across the motor. Inputs more positive than 5V result in motor current flow from left to right (see Figure 2). Inputs less than 5V drive the motor in the opposite direction.

The amplifiers are especially well-suited for applications such as this. The extended common mode range allows command inputs as low as 0V. The output swing lets it drive within 2V of the supply at an output of 1A. This means that a command input that ranges from 0 to 10V will drive a 24V motor from full scale CCW to full scale CW at  $\pm 1A$ .



**FIGURE 3.** External connections



**ABSOLUTE MAXIMUM RATINGS**

SUPPLY VOLTAGE, total	5V to 40V
OUTPUT CURRENT	SOA
POWER DISSIPATION, internal (PA60EU, 1 amplifier)	19.89W
POWER DISSIPATION, internal (PA60DK, 1 amplifier)	17.46W
POWER DISSIPATION, internal (PA60EU, 2 amplifiers) <sup>4</sup>	31.82W
POWER DISSIPATION, internal (PA60DK, 2 amplifiers) <sup>4</sup>	25.60W
INPUT VOLTAGE, differential	±Vs
INPUT VOLTAGE, common mode	+Vs, -Vs, -5V
JUNCTION TEMPERATURE, max. <sup>1</sup>	150°C
TEMPERATURE, pin solder - 10 secs max.	220°C
TEMP RANGE STORAGE	-55°C to 150°C
OPERATING TEMP RANGE, case <sup>1</sup>	-40°C to 125°C

**SPECIFICATIONS (PER AMPLIFIER)**

PARAMETER	TEST CONDITIONS <sup>1,2</sup>	MIN	TYP	MAX	UNTS
<b>INPUT</b>					
OFFSET VOLTAGE, initial			1	15	mV
OFFSET VOLTAGE, vs. temperature	Full temp range		20		μV/°C
BIAS CURRENT, initial			100	500	nA
COMMON MODE RANGE	Full temp range	-Vs		+Vs - 1.3	V
COMMON MODE REJECTION, DC		60	90		dB
POWER SUPPLY REJECTION	Full temp range	60	90		dB
CHANNEL SEPARATION	I <sub>OUT</sub> = 500mA, f = 1kHz	50	68		dB
INPUT NOISE VOLTAGE	R <sub>S</sub> = 100Ω, f = 1 to 100kHz		22		nV/√Hz
<b>GAIN</b>					
OPEN LOOP GAIN	V <sub>o</sub> = ±10V, R <sub>L</sub> = 2.0KΩ	89	100		dB
GAIN BANDWIDTH PRODUCT	f = 100kHz, C <sub>L</sub> = 100pF, R <sub>L</sub> = 2.0KΩ	0.9	1.4		MHz
PHASE MARGIN	Full temp range, C <sub>L</sub> = 100pF, R <sub>L</sub> = 2KΩ		65		°C
POWER BANDWIDTH	V <sub>o</sub> (P-P) = 28V		13.6		kHz
<b>OUTPUT</b>					
CURRENT, peak (PA60DK)				1.0	A
CURRENT, peak (PA60EU)				1.5	A
SLEW RATE		1.0	1.4		V/μS
VOLTAGE SWING	Full temp range, I <sub>o</sub> = 100mA	V <sub>s</sub>   - 1.1	V <sub>s</sub>   - 0.8		V
VOLTAGE SWING	Full temp range, I <sub>o</sub> = 1A	V <sub>s</sub>   - 1.8	V <sub>s</sub>   - 1.4		V
HARMONIC DISTORTION	A <sub>v</sub> = 1, R <sub>L</sub> = 50Ω, V <sub>o</sub> = .5VRMS, f = 1kHz		.02		%
<b>POWER SUPPLY</b>					
VOLTAGE, V <sub>SS</sub> <sup>3</sup>		5	30	40	V
CURRENT, quiescent total			8	10	mA
<b>THERMAL</b>					
RESISTANCE, junction to case					
DC, 1 amplifier, (PA60EU)			5.71	6.29	°C/W
DC, 1 amplifier, (PA60DK)			6.51	7.16	°C/W
DC, 2 amplifiers, (PA60EU) <sup>4</sup>			3.57	3.93	°C/W
DC, 2 amplifiers, (PA60DK) <sup>4</sup>			4.44	4.88	°C/W
AC, 1 amplifier, (PA60EU)			4.29	4.71	°C/W
AC, 1 amplifier, (PA60DK)			4.88	5.37	°C/W
AC, 2 amplifiers, (PA60EU) <sup>4</sup>			2.68	2.95	°C/W
AC, 2 amplifiers, (PA60DK) <sup>4</sup>			3.33	3.66	°C/W
RESISTANCE, junction to air (PA60EU)			30		°C/W
RESISTANCE, junction to air (PA60DK) <sup>6</sup>			25		°C/W

- Notes:
1. Long term operation at the maximum junction temperature will result in reduced product life. Derate internal power dissipation to achieve high MTTF.
  2. Unless otherwise noted, the following conditions apply: ±V<sub>S</sub> = ±15V, T<sub>C</sub> = 25°C.
  3. +V<sub>S</sub> and -V<sub>S</sub> denote the positive and negative rail respectively. V<sub>SS</sub> denotes total rail-to-rail supply.
  4. Rating applies when power dissipation is equal in each of the amplifiers.
  5. If -V<sub>S</sub> is disconnected before +V<sub>S</sub>, a diode between -V<sub>S</sub> and ground is recommended to avoid damage.
  6. Rating applies when the heatslug of the DK package is soldered to a minimum of 1 square inch foil area of a printed circuit board.

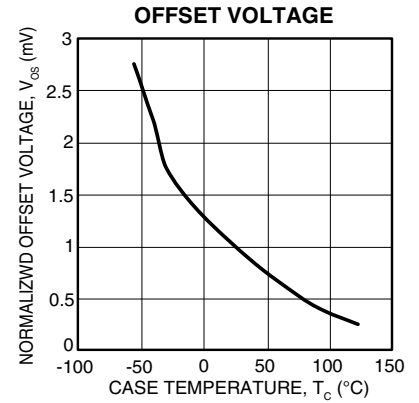
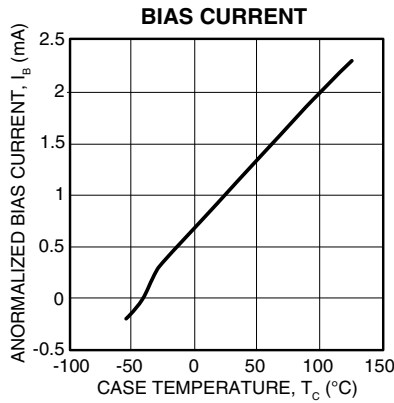
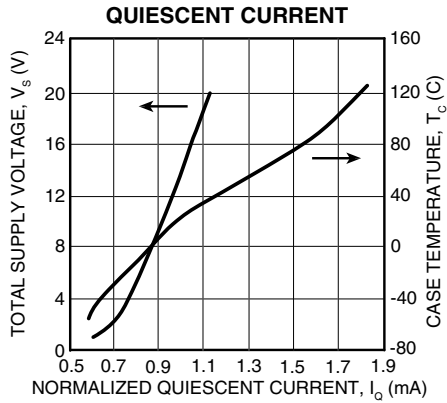

PHASE MARGIN vs. OUTPUT LOAD CAPACITANCE

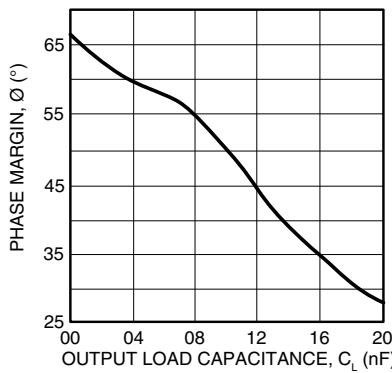

VOLTAGE GAIN & PHASE vs. FREQUENCY

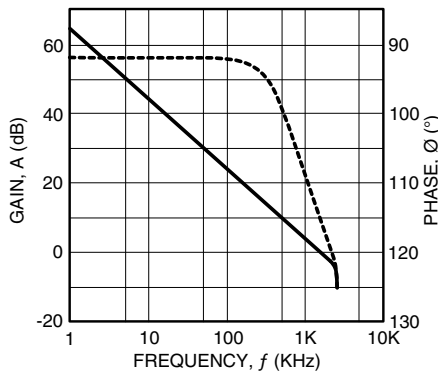

OUTPUT VOLTAGE SWING

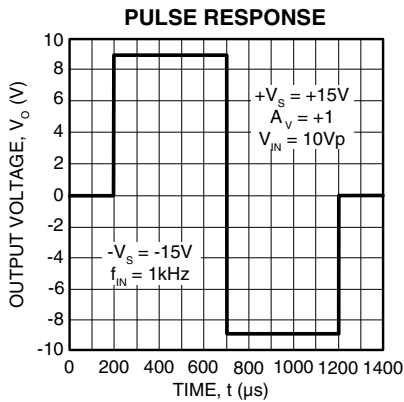
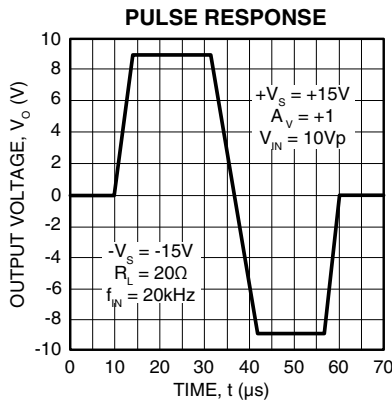
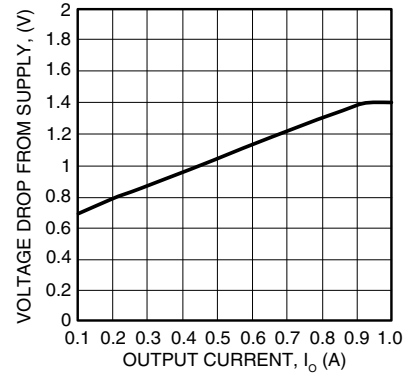

**GENERAL**

Please read Application Note 1 "General Operating Considerations" which covers stability, supplies, heatsinking, mounting, SOA interpretation, and specification interpretation. Visit [www.apexmicrotech.com](http://www.apexmicrotech.com) for design tools that help automate tasks such as calculations for stability, internal power dissipation, heatsink selection; Apex's complete Application Notes library; Technical Seminar Workbook; and Evaluation Kits.

**STABILITY CONSIDERATIONS**

All monolithic power op amps use output stage topologies that present special stability problems. This is primarily due to non-complementary (both devices are NPN) output stages with a mismatch in gain and phase response for different polarities of output current. It is difficult for the op amp manufacturer to optimize compensation for all operating conditions.

**THERMAL CONSIDERATIONS**

The PA60EU has a large exposed copper heat tab to which the monolithic is directly attached. The PA60EU may require a thermal washer, which is electrically insulating since the tab is directly tied to -VS. This can result in a thermal impedance RCS of up to 1°C/W or greater.

The PA60DK has a large exposed integrated copper heatslug to which the monolithic is directly attached. The solder connection of the heatslug to a minimum of 1 square inch foil area of the printed circuit board will result in thermal performance of 25°C/W junction to air rating of the PA60DK. Solder connection to an area of 1 to 2 square inches of foil is required for minimal power applications

Where the PA60DK is used in higher power applications, it is necessary to use surface mount techniques of heatsinking. Surface mount techniques include the use of a surface mount fan in combination with a surface mount heatsink on the backside of the FR4/ PC board with through hole thermal vias. Other highly thermal conductive substrate board materials are available for maximum heat sinking.

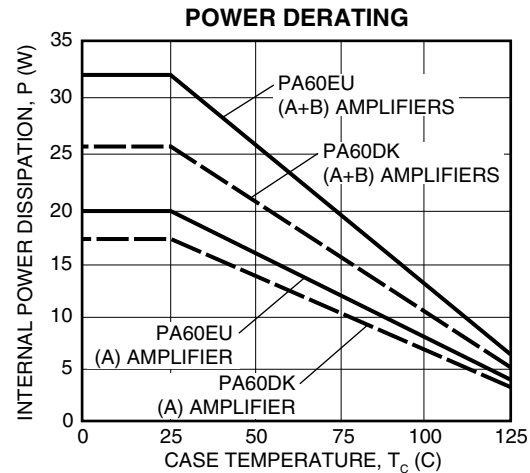
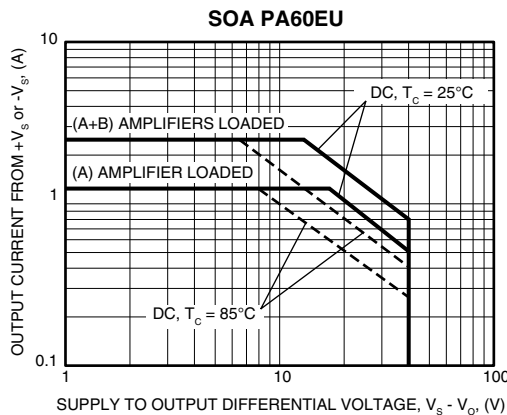
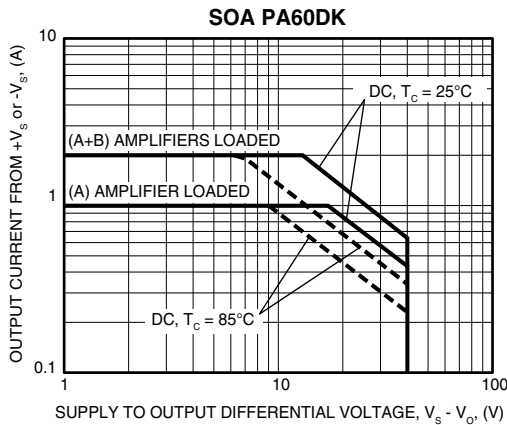

**MOUNTING PRECAUTIONS**

1. Always use a heat sink. Even unloaded the PA60DK and PA60EU can dissipate up to .4 watts.
2. Avoid bending the leads. Such action can lead to internal damage.
3. Always fasten the tab of the EU package to the heat sink before the leads are soldered to fixed terminals.
4. Strain relief must be provided if there is any probability of axial stress to the leads.

**SAFE OPERATING AREA (SOA)**

The SOA curves combine the effect of all limits for this power op amp. For a given application, the direction and magnitude of the output current should be calculated or measured and checked against the SOA curves. This is simple for resistive loads but more complex for reactive and EMF generating loads. The following guidelines may save extensive analytical efforts.