



Chipsmall Limited consists of a professional team with an average of over 10 year of expertise in the distribution of electronic components. Based in Hongkong, we have already established firm and mutual-benefit business relationships with customers from,Europe,America and south Asia,supplying obsolete and hard-to-find components to meet their specific needs.

With the principle of “Quality Parts,Customers Priority,Honest Operation,and Considerate Service”,our business mainly focus on the distribution of electronic components. Line cards we deal with include Microchip,ALPS,ROHM,Xilinx,Pulse,ON,Everlight and Freescale. Main products comprise IC,Modules,Potentiometer,IC Socket,Relay,Connector.Our parts cover such applications as commercial,industrial, and automotives areas.

We are looking forward to setting up business relationship with you and hope to provide you with the best service and solution. Let us make a better world for our industry!



Contact us

Tel: +86-755-8981 8866 Fax: +86-755-8427 6832

Email & Skype: info@chipsmall.com Web: www.chipsmall.com

Address: A1208, Overseas Decoration Building, #122 Zhenhua RD., Futian, Shenzhen, China



Description

The PAM8904 is a piezo sounder driver with integrated a charge pump boost converter. The PAM8904 is capable for driving a ceramic/piezo sounder with 18Vpp from a 3V power supply. The charge pump can operate in either of a 1X, 2X and 3X mode.

The boost converter operates at a fixed frequency of 1.0MHz and provides a 9V output with a minimum number of external components. The PAM8904 can drive up to 15nF loading. PAM unique drive technology provides small inrush current, low EMI and high efficiency.

PAM8904 built-in automatic shutdown and wake up that guarantees longer battery life.

PAM8904 features thermal shutdown, over current protection, over voltage protection and under voltage lock-out.

The PAM8904 is available in a 16pin U-QFN3030 package.

Features

- Supply voltage Range From 2.3V to 5.5V
- 18V_{PP} Output from a 3V Supply
- Integrated Boost Converter Generates 9V Supply
- Input signal 20 Hz to 300KHz
- No Voltage Cross Output At Shutdown Mode
- Low Current Consumption
- Automatic Standby and Wake-up Control
- Available in Space Saving Packages 16pin QFN package

Pin Assignments

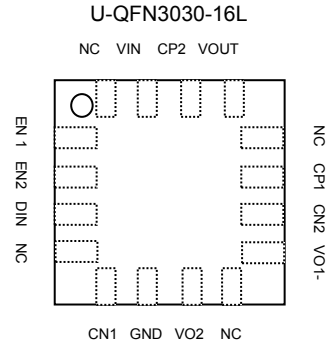

Applications

- Health Care System
- Alarm Clock
- Security Device
- Home Appliance

Typical Applications Circuit

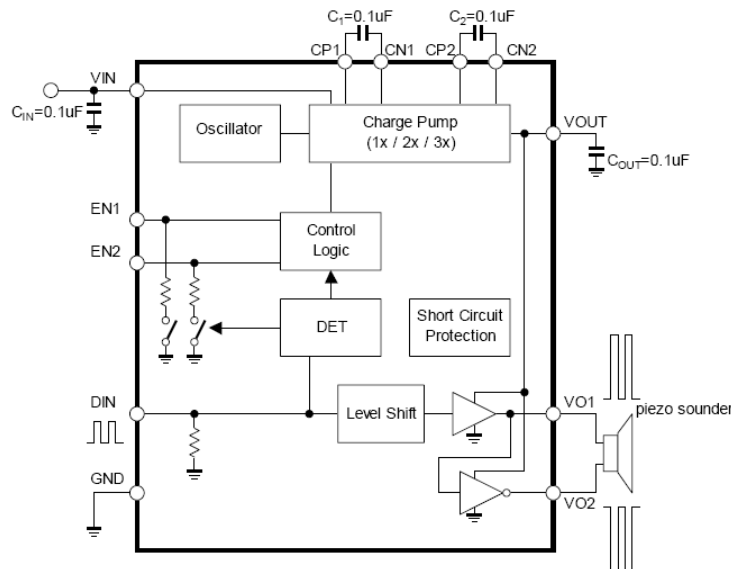

Pin Descriptions

Pin Name	I/O/P	Function
VIN	P	Power Supply
EN1	I	Charge pump mode select 1
EN2	I	Charge pump mode select 2
DIN	I	Signal Input
CN1	I	Capacitor 1 Negative Terminal
GND	P	Ground
VO2	O	Positive Output
VO1	O	Negative Output
CN2	I	Capacitor 2 Negative Terminal
CP1	I	Capacitor 1 Positive Terminal
VO2	O	Boost Output
CP2	I	Capacitor 2 Positive Terminal
NC	—	No Connect

Absolute Maximum Ratings (@ T_A = +25°C, unless otherwise specified.)

Symbol	Characteristics	Value	Unit
V _{IN}	Supply Voltage	-0.3 to +6.0	V
V _I	EN1, EN2	GND -0.3 to V _{IN} +0.3	V
T _A	Operating Free-Air Temperature Range	-40 to +85	°C
T _J	Operating Junction Temperature Range	-40 to +150	°C
T _{STG}	Storage Temperature Range	-65 to +150	°C

Recommended Operating Conditions (@ T_A = +25°C, unless otherwise specified.)

Symbol	Characteristics	Min	Max	Unit
V _{IN}	Supply Voltage	2.3	5.0	V
V _{IH}	High-Level Input Voltage	EN1, EN2 1.2 to V _{IN} +0.3		V
V _{IL}	Low-Level Input Voltage	EN1, EN2 -0.3 to +0.4		V
T _A	Operating Free-Air Temperature	-40	+85	°C

Thermal Information

Parameter	Symbol	Package	Maximum	Unit
Thermal Resistance (Junction to Ambient)	θ _{JA}	U-QFN3030-16L	35	°C/W
Thermal Resistance (Junction to Case)	θ _{JC}	U-QFN3030-16L	14	°C/W

Electrical Characteristics (@ $T_A = +25^\circ\text{C}$, $V_{IN}=3.0\text{V}$, $C_{PIEZO}=15\text{nF}$, $f_{DIN}=4\text{KHz}$, unless otherwise specified.)

Parameter	Symbol	Conditions	Min	Typ	Max	Unit
Output Voltage	V_{OUT1}	1x Mode	2.8		3	V
	V_{OUT2}	2x Mode	5.2		6	V
	V_{OUT3}	3x Mode	7.2		9	V
Operating Current 1	I_{DD11}	1x Mode, $C_{PIEZO} = \text{No Load}$		50		μA
	I_{DD12}	2x Mode, $C_{PIEZO} = \text{No Load}$		720		μA
	I_{DD13}	3x Mode, $C_{PIEZO} = \text{No Load}$		1700		μA
Operating Current 2	I_{DD21}	1x Mode, Single-ended application		0.3		mA
	I_{DD22}	2x Mode, Single-ended application		1.4		mA
	I_{DD23}	3x Mode, Single- ended application		3.9		mA
Operating Current 3	I_{DD31}	1x Mode, Differential application		0.9		mA
	I_{DD32}	2x Mode, Differential application		3.6		mA
	I_{DD33}	3x Mode, Differential application		7.9		mA
Shutdown Current	I_{SD}	DIN = 0V			1	μA
Input Frequency	f_{IN}	Rectangular pulse		4		kHz
Oscillating Frequency	f_{OSC}			1		MHz
VOU Start Delay Time	T_{ON1}	1x Mode, From DIN signal High to 90% V_{OUT} steady state		270		μs
	T_{ON2}	2x Mode, From DIN signal High to 90% V_{OUT} steady state		320		μs
	T_{ON3}	3x Mode From DIN signal High to 90% V_{OUT} steady state		350		μs
Shutdown Delay Time	T_{OFF}	DIN = H- >L		42		ms
Output Short-circuit Current	I_{SC}			40		mA
Control Terminal Voltage H	V_{IH}	EN1, EN2, DIN pins	$0.8 \cdot V_{IN}$		V_{IN}	V
Control Terminal Voltage L	V_{IL}	EN1, EN2, DIN pins	0		$0.2 \cdot V_{IN}$	V
Control Terminal Current 1	I_{IH1}	DIN = 3V			1	μA
Control Terminal Current 2	I_{IH2}	VEN1, VEN2 = 3V, DIN = 3V			1	μA
Control Terminal Current 3	I_{IH3}	VEN1, VEN2 = 3V, DIN = 0V			1	μA

Application Information

Charge Pump Mode Setting

DIN	EN1	EN2	MODE
0	—	—	Shutdown Mode
1	0	0	Shutdown Mode
1	0	1	1X Mode
1	1	0	2X Mode
1	1	1	3X Mode

Timing Chart

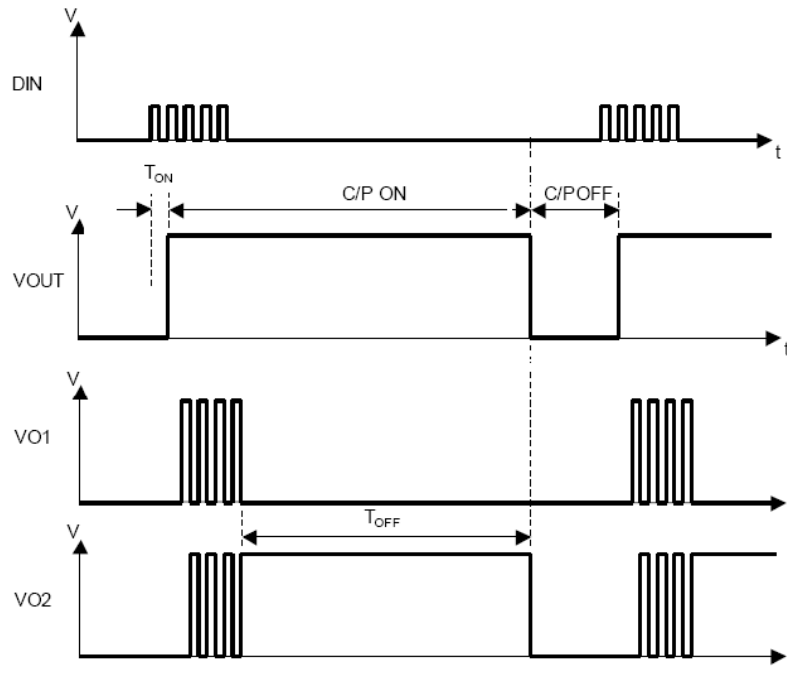

Ordering Information

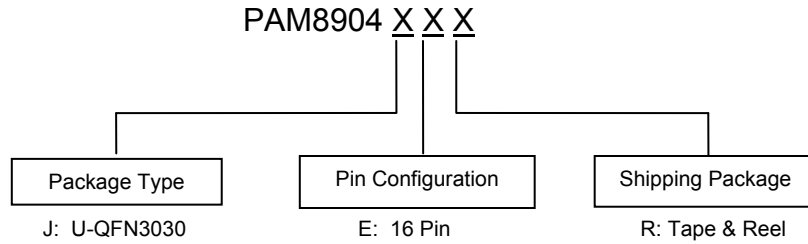

Part Number	Package Type	Shipping
PAM8904JER	U-QFN3030-16L	3,000/Tape & Reel

Marking Information

U-QFN3030-16L

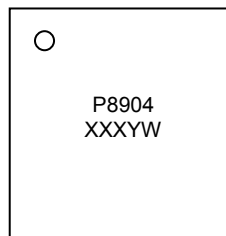

Package Outline Dimensions (All dimensions in mm.)

Please see AP02002 at <http://www.diodes.com/datasheets/ap02002.pdf> for the latest version.

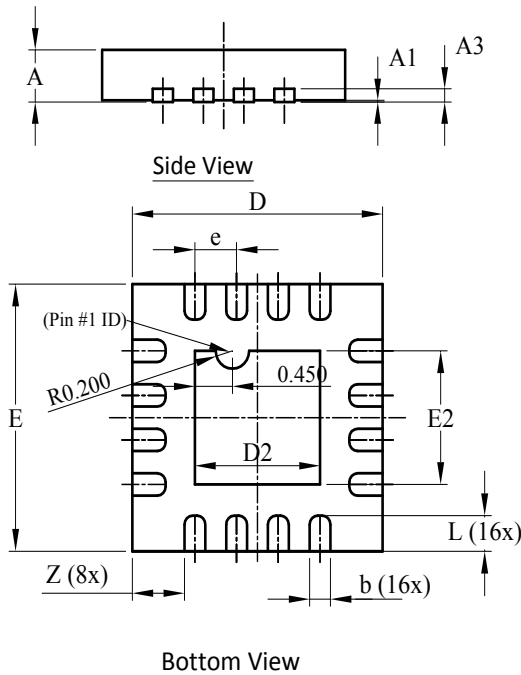

U-QFN3030-16 Type B			
Dim	Min	Max	Typ
A	0.55	0.65	0.60
A1	0	0.05	0.02
A3	—	—	0.15
b	0.18	0.28	0.23
D	2.95	3.05	3.00
D2	1.40	1.60	1.50
E	2.95	3.05	3.00
E2	1.40	1.60	1.50
e	—	—	0.50
L	0.35	0.45	0.40
Z	—	—	0.625

All Dimensions in mm

Suggested Pad Layout

Please see AP02001 at <http://www.diodes.com/datasheets/ap02001.pdf> for the latest version

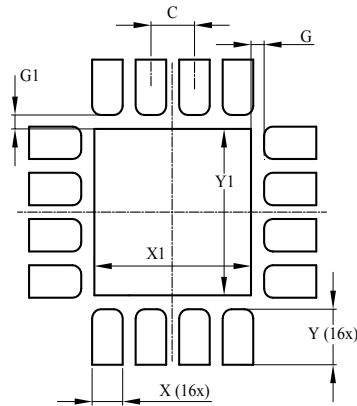

Dimensions	Value (in mm)
C	0.500
G	0.150
G1	0.150
X	0.350
X1	1.800
Y	0.600
Y1	1.800

IMPORTANT NOTICE

DIODES INCORPORATED MAKES NO WARRANTY OF ANY KIND, EXPRESS OR IMPLIED, WITH REGARDS TO THIS DOCUMENT, INCLUDING, BUT NOT LIMITED TO, THE IMPLIED WARRANTIES OF MERCHANTABILITY AND FITNESS FOR A PARTICULAR PURPOSE (AND THEIR EQUIVALENTS UNDER THE LAWS OF ANY JURISDICTION).

Diodes Incorporated and its subsidiaries reserve the right to make modifications, enhancements, improvements, corrections or other changes without further notice to this document and any product described herein. Diodes Incorporated does not assume any liability arising out of the application or use of this document or any product described herein; neither does Diodes Incorporated convey any license under its patent or trademark rights, nor the rights of others. Any Customer or user of this document or products described herein in such applications shall assume all risks of such use and will agree to hold Diodes Incorporated and all the companies whose products are represented on Diodes Incorporated website, harmless against all damages.

Diodes Incorporated does not warrant or accept any liability whatsoever in respect of any products purchased through unauthorized sales channel. Should Customers purchase or use Diodes Incorporated products for any unintended or unauthorized application, Customers shall indemnify and hold Diodes Incorporated and its representatives harmless against all claims, damages, expenses, and attorney fees arising out of, directly or indirectly, any claim of personal injury or death associated with such unintended or unauthorized application.

Products described herein may be covered by one or more United States, international or foreign patents pending. Product names and markings noted herein may also be covered by one or more United States, international or foreign trademarks.

This document is written in English but may be translated into multiple languages for reference. Only the English version of this document is the final and determinative format released by Diodes Incorporated.

LIFE SUPPORT

Diodes Incorporated products are specifically not authorized for use as critical components in life support devices or systems without the express written approval of the Chief Executive Officer of Diodes Incorporated. As used herein:

A. Life support devices or systems are devices or systems which:

1. are intended to implant into the body, or
2. support or sustain life and whose failure to perform when properly used in accordance with instructions for use provided in the labeling can be reasonably expected to result in significant injury to the user.

B. A critical component is any component in a life support device or system whose failure to perform can be reasonably expected to cause the failure of the life support device or to affect its safety or effectiveness.

Customers represent that they have all necessary expertise in the safety and regulatory ramifications of their life support devices or systems, and acknowledge and agree that they are solely responsible for all legal, regulatory and safety-related requirements concerning their products and any use of Diodes Incorporated products in such safety-critical, life support devices or systems, notwithstanding any devices- or systems-related information or support that may be provided by Diodes Incorporated. Further, Customers must fully indemnify Diodes Incorporated and its representatives against any damages arising out of the use of Diodes Incorporated products in such safety-critical, life support devices or systems.

Copyright © 2013, Diodes Incorporated

www.diodes.com