



Chipsmall Limited consists of a professional team with an average of over 10 year of expertise in the distribution of electronic components. Based in Hongkong, we have already established firm and mutual-benefit business relationships with customers from,Europe,America and south Asia,supplying obsolete and hard-to-find components to meet their specific needs.

With the principle of "Quality Parts,Customers Priority,Honest Operation,and Considerate Service",our business mainly focus on the distribution of electronic components. Line cards we deal with include Microchip,ALPS,ROHM,Xilinx,Pulse,ON,Everlight and Freescale. Main products comprise IC,Modules,Potentiometer,IC Socket,Relay,Connector.Our parts cover such applications as commercial,industrial, and automotives areas.

We are looking forward to setting up business relationship with you and hope to provide you with the best service and solution. Let us make a better world for our industry!



## Contact us

Tel: +86-755-8981 8866 Fax: +86-755-8427 6832

Email & Skype: info@chipsmall.com Web: www.chipsmall.com

Address: A1208, Overseas Decoration Building, #122 Zhenhua RD., Futian, Shenzhen, China





### Vishay Dale Thin Film Land Patterns

#### 1. Scope

This technical note provides sample land patterns for Vishay Dale Thin Film SMT resistive products. The following drawings are based on IPC-SM-782 Surface Mount Design and Land Pattern Standard. These drawings are for reference only Vishay Thin Film recommends that the user contacts their PC board supplier for actual land patterns required. The pads are intended for lead (Pb)-free and tin / lead solder types.

#### 2. Product Series

Thin Film Surface Mount Chip Resistors (FC, L, P, PTN, PLT, PLTT, PLTU, PAT, PATT, PNM, M/D55342 QPL Series)

**0402 Land Pattern**

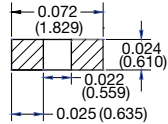

**0502 Land Pattern**

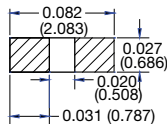

**0505 Land Pattern**

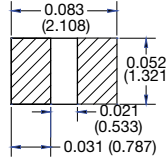

**0603 Land Pattern**

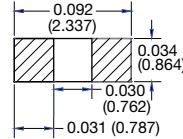

**0705 Land Pattern**

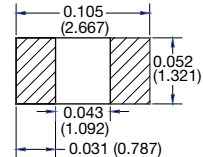

**1005 Land Pattern**

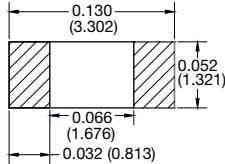

**1010 Land Pattern**

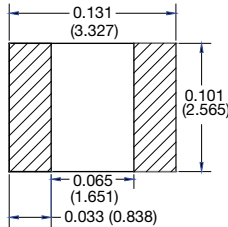

**1206 Land Pattern**

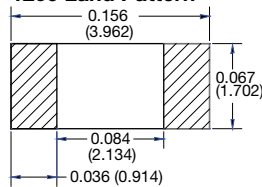

**1505 Land Pattern**

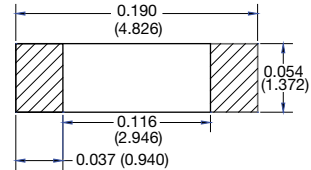

**2010 Land Pattern**

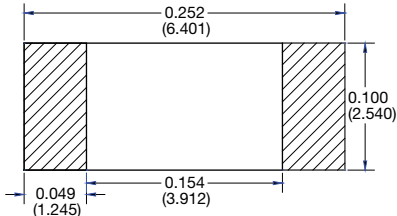

**2208 Land Pattern**

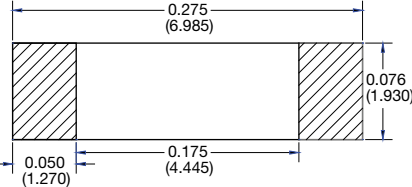

**2512 Land Pattern**

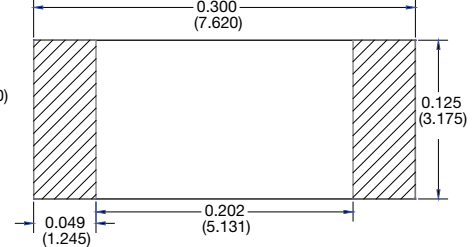



### Thin Film Surface Mount Chip Resistors (PHP, PCAN Series)

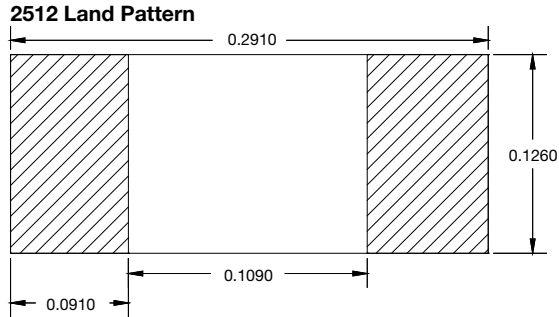
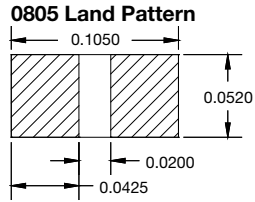
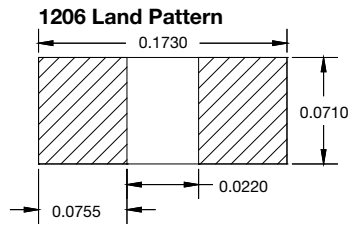
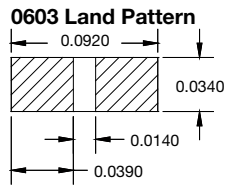

### Thin Film Surface Mount Chip Resistors Long Axis Termination (L Series)

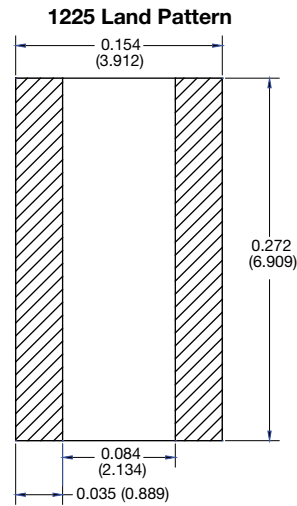
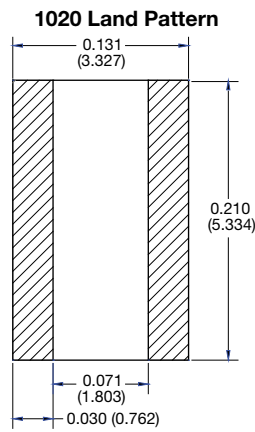
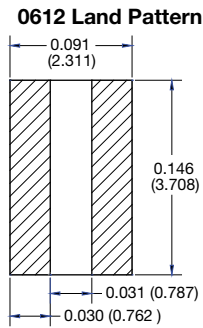
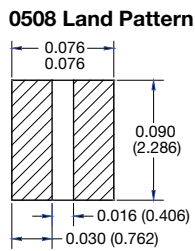



### Surface Mount Networks (MPM, MP3, MP4 Series)

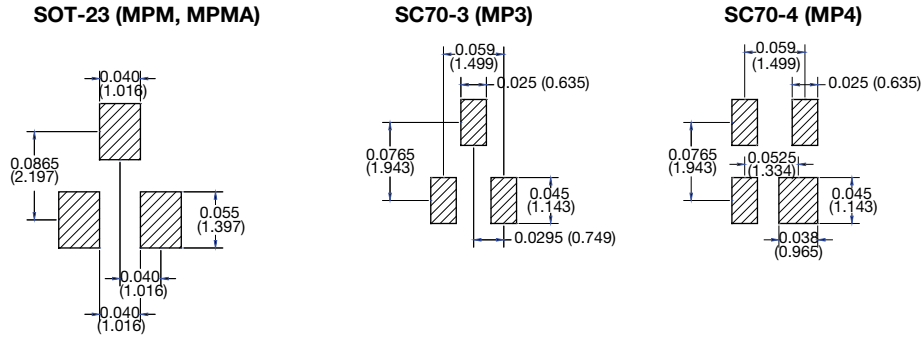

### Surface Mount Networks SOIC Narrow Body 150 mils (ORN, CSO, MOMC, HTRN, AORN, MORN Series)

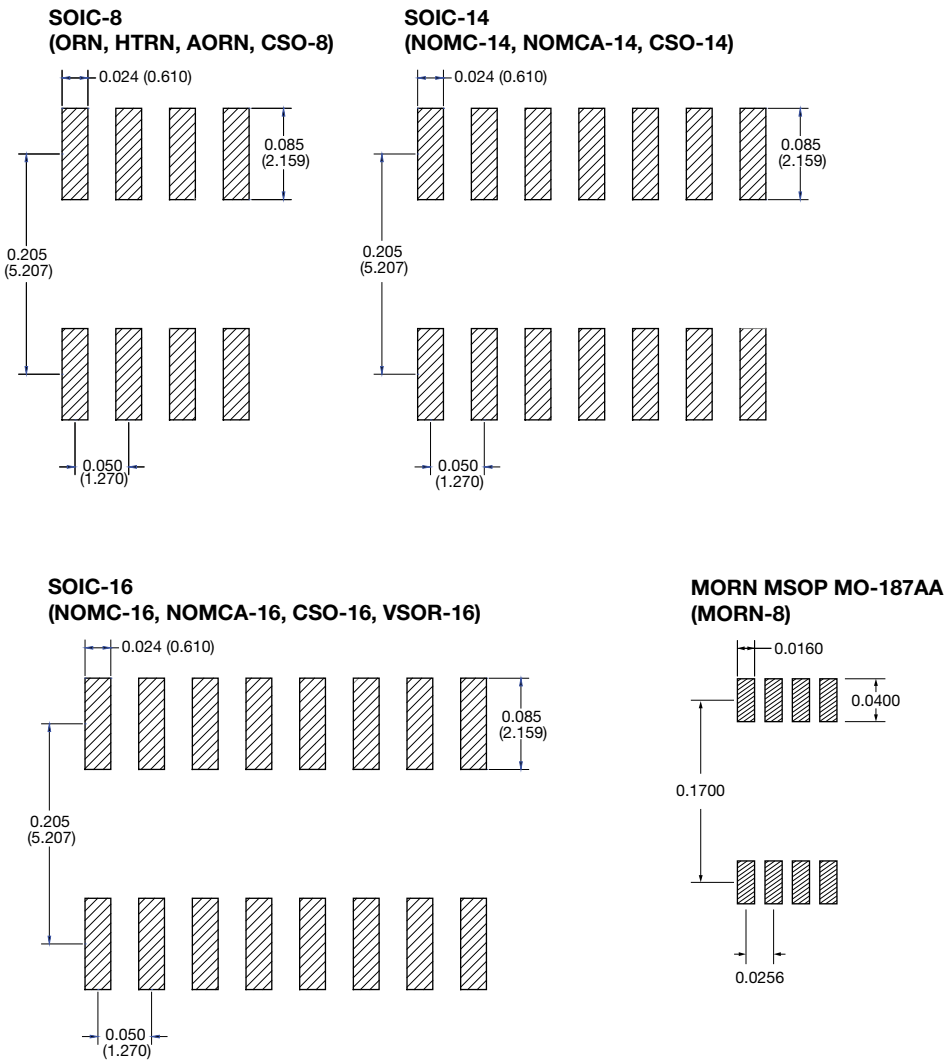



### Surface Mount Networks SOIC Medium Body 220 mils (TOMC Series)

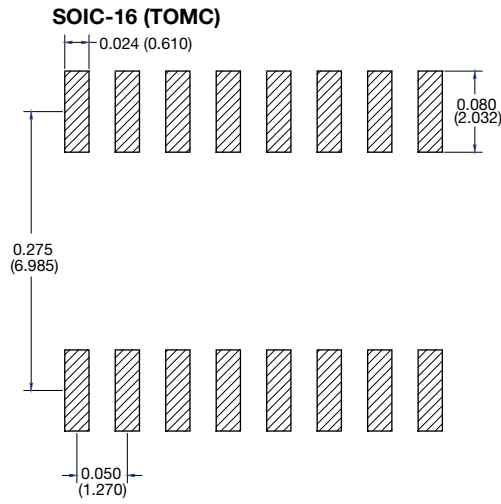

### Surface Mount Networks SOIC Wide Body 300 mils (WOMC Series)

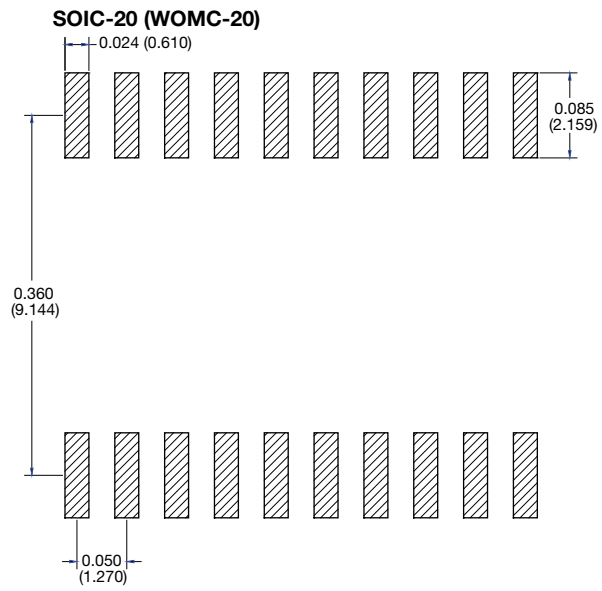
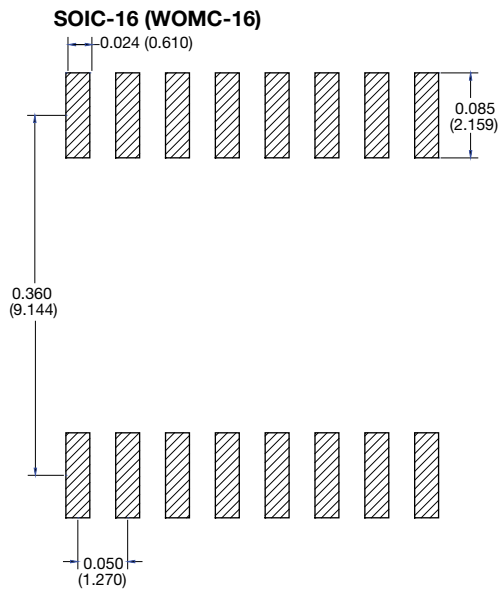



### Surface Mount Networks High Density SSOP, TSOP (VSSR, VTSR Series)

#### SSOP MO-137

##### VSSR-16

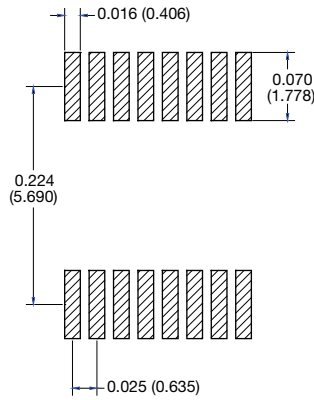

##### OSOP-16, OSOP-20, OSOP-24, VSSR-20

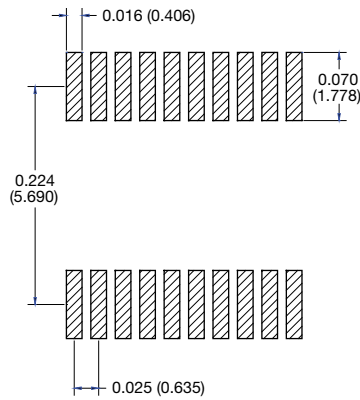

##### VSSR-24, HD-CSO-24

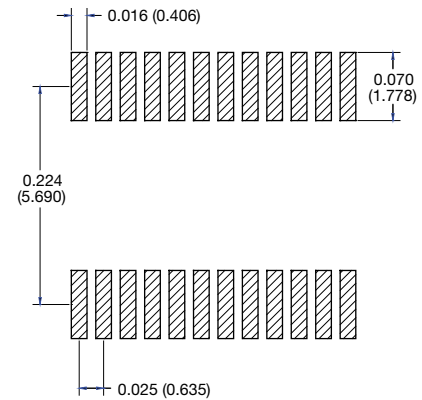

#### TSSOP MO-153

##### VTSR-16

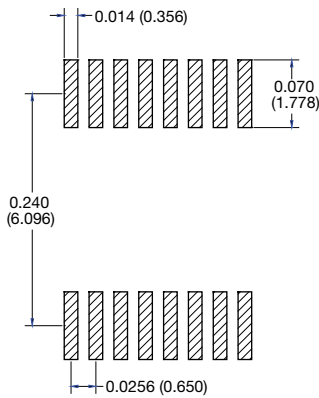

##### VTSR-20

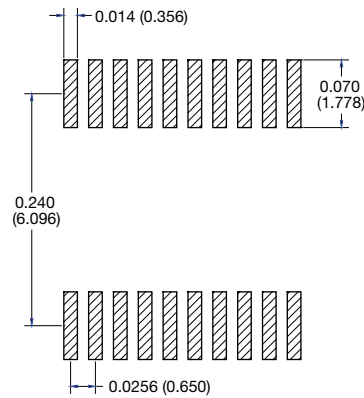

##### VTSR-24

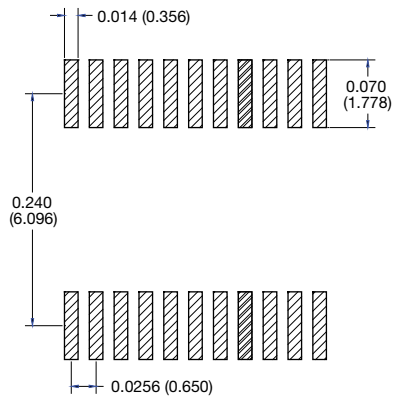

Surface Mount Leadless Networks (LCC Series)

**16 Pin LCC**

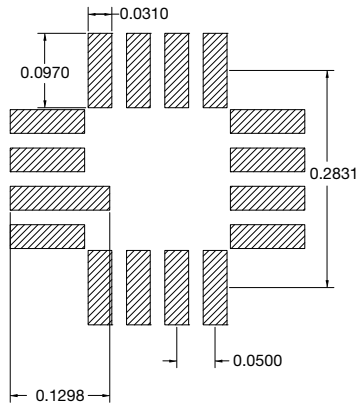

**20 Pin LCC**

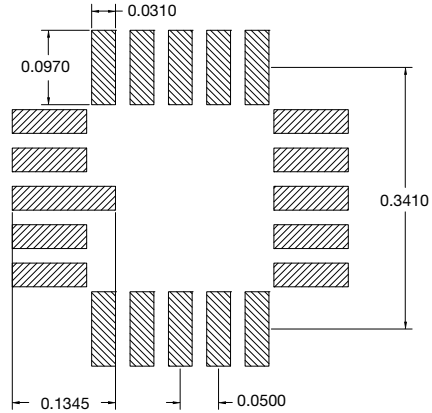

Surface Mount Leadless Networks (MPH Series)

**4 Pin LCC**

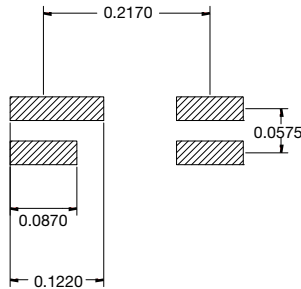

Surface Mount Leadless Packages DUAL/ QUAD Flat No Lead (DFN, QFN Series)

**DFN MLP**

**DFN-8 4 x 5 mm Sq**

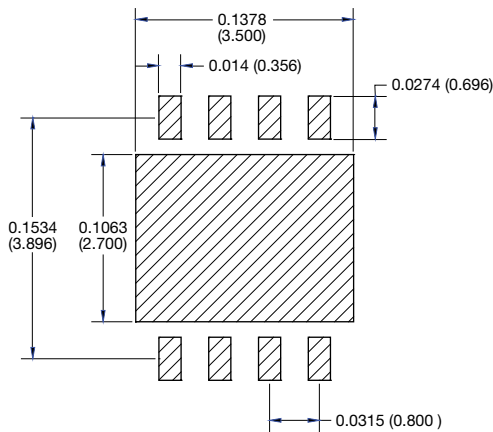

**QFN MLP**

**QFN-20 5 x 5 mm Sq**

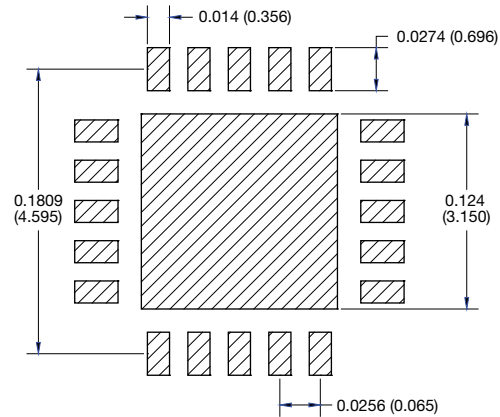



### Surface Mount Leadless Resistor Arrays (PR Series)

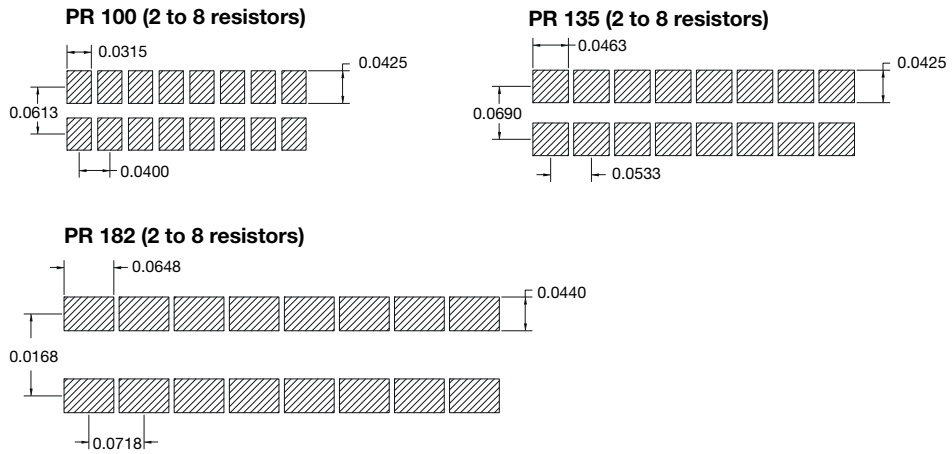

#### Note

- All dimensions in inches (mm)

### Flatpack

