



Chipsmall Limited consists of a professional team with an average of over 10 year of expertise in the distribution of electronic components. Based in Hongkong, we have already established firm and mutual-benefit business relationships with customers from,Europe,America and south Asia,supplying obsolete and hard-to-find components to meet their specific needs.

With the principle of “Quality Parts,Customers Priority,Honest Operation,and Considerate Service”,our business mainly focus on the distribution of electronic components. Line cards we deal with include Microchip,ALPS,ROHM,Xilinx,Pulse,ON,Everlight and Freescale. Main products comprise IC,Modules,Potentiometer,IC Socket,Relay,Connector.Our parts cover such applications as commercial,industrial, and automotives areas.

We are looking forward to setting up business relationship with you and hope to provide you with the best service and solution. Let us make a better world for our industry!



Contact us

Tel: +86-755-8981 8866 Fax: +86-755-8427 6832

Email & Skype: info@chipsmall.com Web: www.chipsmall.com

Address: A1208, Overseas Decoration Building, #122 Zhenhua RD., Futian, Shenzhen, China



MODEL PAXLSG - PAX LITE STRAIN GAGE METER / MILLIVOLT METER



- 3 1/2-DIGIT, 0.56" (14.2 MM) HIGH RED LED READOUT
- HIGH SENSITIVITY, 10 MV FULL SCALE
- WIDE RANGE GAIN AND OFFSET ADJUSTMENTS
- BUILT-IN EXCITATION 5 OR 10 VDC
- APPLICABLE AS REGULAR MILLIVOLT INDICATOR (SINGLE-ENDED OR DIFFERENTIAL INPUT)
- SELECTABLE DECIMAL POINTS
- OVER-RANGE INDICATION
- NEMA 4X/IP65 SEALED FRONT BEZEL
- OPTIONAL CUSTOM UNITS OVERLAY WITH BACKLIGHT



GENERAL DESCRIPTION

The Model PAXLSG expands the PAX Lite capabilities into the indication of pressure, load, force, and other parameters measured with strain gages. The unit features broad range scaling and can be used with a wide variety of strain gage resistances and bridge configurations. A built-in excitation source is jumper selectable for 5 or 10 VDC @ 120 mA maximum, and can power up to four full 350 Ω bridges in load averaging applications. Although designed primarily for strain-gage indication, the PAXLSG is also ideal for single-ended or differential millivolt input applications, with full-scale input ranges from 0 to 10 mV thru 0 to 2 VDC. Adjustable scaling and offset allow direct readout in nearly any engineering unit.

The meter has a NEMA 4X/IP65 sealed bezel and extensive testing of noise effects to CE requirements, allowing the meter to provide a tough yet reliable application solution.

SAFETY SUMMARY

All safety related regulations, local codes and instructions that appear in the literature or on equipment must be observed to ensure personal safety and to prevent damage to either the instrument or equipment connected to it. If equipment is used in a manner not specified by the manufacturer, the protection provided by the equipment may be impaired.



CAUTION: Risk of Danger.
 Read complete instructions prior to installation and operation of the unit.



CAUTION: Risk of electric shock.

DIMENSIONS In inches (mm)

Note: Recommended minimum clearance (behind the panel) for mounting clip installation is 2.1" (53.4) H x 5.0" (127) W.

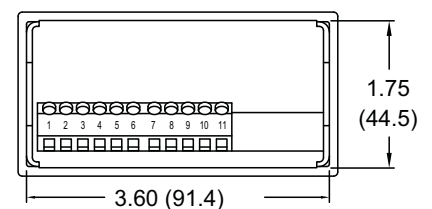
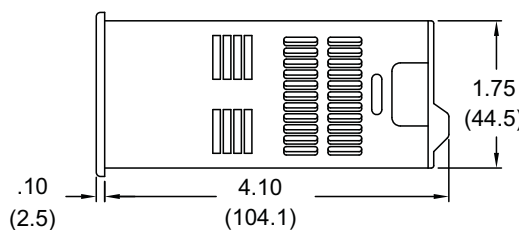
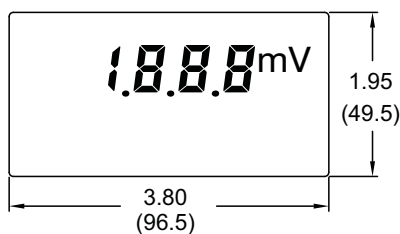

TABLE OF CONTENTS

Ordering Information	2	Wiring the Meter	5
General Meter Specifications	3	Scaling the Meter	6
Accessories	3	Calibrating the Meter	7
Installing the Meter	4	Applications	8
Setting the Jumpers and Switches	4		

ORDERING INFORMATION

Meter Part Numbers



SG - Strain Gage Meter

Accessories Part Numbers

TYPE	MODEL NO.	DESCRIPTION	PART NUMBERS
Accessories	PAXLBK	Units Label Kit Accessory	PAXLBK30

GENERAL METER SPECIFICATIONS

1. **DISPLAY:** 3 1/2-digit, 0.56" (14.2 mm) high, 7-segment red LED, (-) minus sign displayed when voltage is negative. Decimal points inserted before 1st, 2nd, or 3rd least significant digits by DIP switch selection.
2. **OVER-RANGE INDICATION:** Indicated by blanking 3 least significant digits.
3. **POWER:**
AC Power: 85 to 250 VAC, 50/60 HZ, 6 VA
Isolation: 2300 Vrms for 1 min. to all inputs.
4. **INPUT SIGNAL:** Single-ended or differential input, ± 2.0 V max. Gain (Sensitivity) is adjustable from 200 Units of Numerical Readout/millivolt input (gives full scale readout of 1999 at 10 mV input), to less than 1 Unit of Numerical Readout/mV (gives full scale readout of 1999 at 2.0 V input). Maximum common mode voltage swing with respect to signal ground, 0 to 7 V.
Note: Absolute maximum voltage that can be applied between the two input terminals or between input and signal common is 50 VDC.
5. **INPUT IMPEDANCE:** 100 M Ω
6. **LINEARITY:** $\pm(0.05\% \pm 1 \text{ digit})$
7. **LOW FREQUENCY NOISE REJECTION:**
Normal Mode Rejection: 84 dB @ 50/60 Hz
Common Mode Rejection: 50 dB with respect to excitation common; 110 dB with respect to earth ground.
8. **RESPONSE TIME:** 2.0 seconds to settle from step input.
9. **READING RATE:** 2.5 updated readings/second, nominal.
10. **EXCITATION SUPPLY:**
Jumper Selectable: 5 VDC @ 60 mA max., $\pm 2\%$
 10 VDC @ 120 mA max., $\pm 2\%$
Temperature coefficient (ratio metric): 20 ppm/ $^{\circ}\text{C}$ max.
11. **ENVIRONMENTAL CONDITIONS:**
Operating Temperature: 0 $^{\circ}$ to 60 $^{\circ}\text{C}$
Storage Temperature: -40 $^{\circ}$ to 80 $^{\circ}\text{C}$
Operating and Storage Humidity: 85% max. relative humidity (non-condensing)
Span Temperature Coeff.: 100 PPM/ $^{\circ}\text{C}$
Offset Temperature Coeff.: 100 PPM/ $^{\circ}\text{C}$
Vibration According to IEC 68-2-6: Operational 5 to 150 Hz, in X, Y, Z direction for 1.5 hours, 2g.
Shock According to IEC 68-2-27: Operational 30 g, 11 msec in 3 directions.
Altitude: Up to 2000 meters
12. **CERTIFICATIONS AND COMPLIANCES:**
SAFETY
 UL Recognized Component, File # E179259, UL61010A-1, CSA C22.2 No. 61010-1 Recognized to U.S. and Canadian requirements under the Component Recognition Program of Underwriters Laboratories, Inc.
 UL Listed, File # E137808, UL508, CSA C22.2 No. 14-M95
 LISTED by Und. Lab. Inc. to U.S. and Canadian safety standards
 Type 4X Enclosure rating (Face only), UL50

- IECEE CB Scheme Test Certificate # UL/8843A/UL
 CB Scheme Test Report # 04ME11209-20041018
 Issued by Underwriters Laboratories, Inc.
 IEC 61010-1, EN 61010-1: Safety requirements for electrical equipment for measurement, control, and laboratory use, Part 1.
 IP65 Enclosure rating (Face only), IEC 529
 IP20 Enclosure rating (Rear of unit), IEC 529

ELECTROMAGNETIC COMPATIBILITY

Emissions and Immunity to EN 61326: Electrical Equipment for Measurement, Control and Laboratory use.

Immunity to Industrial Locations:

Electrostatic discharge	EN 61000-4-2	Criterion A 4 kV contact discharge 8 kV air discharge
Electromagnetic RF fields	EN 61000-4-3	Criterion B 10 V/m
Fast transients (burst)	EN 61000-4-4	Criterion B 2 kV power 2 kV signal
Surge	EN 61000-4-5	Criterion A 1 kV L-L, 2 kV L&N-E power 1 kV signal
RF conducted interference	EN 61000-4-6	Criterion A 3 V/rms
Power frequency magnetic fields	EN 61000-4-8	Criterion A 30 A/m
Voltage dip/interruptions	EN 61000-4-11	Criterion A 0.5 cycle

Emissions:

Emissions	EN 55011	Class B
-----------	----------	---------

Notes:

1. *Criterion A: Normal operation within specified limits.*
2. *Criterion B: Temporary loss of performance from which the unit self-recovers.*

13. **CONNECTIONS:** High compression cage-clamp terminal block
Wire Strip Length: 0.3" (7.5 mm)
Wire Gauge: 30-14 AWG copper wire
Torque: 4.5 inch-lbs (0.51 N-m) max.
14. **CONSTRUCTION:** This unit is rated for NEMA 4X/IP65 outdoor use. IP20 Touch safe. Installation Category II, Pollution Degree 2. One piece bezel/case. Flame resistant. Panel gasket and mounting clip included.
15. **WEIGHT:** 0.65 lbs (0.24 kg)

ACCESSORIES

UNITS LABEL KIT (PAXLBK)

Each meter has a units indicator with backlighting that can be customized using the Units Label Kit. The backlight is controlled by a DIP switch.

1.0 INSTALLING THE METER

Installation

The PAX meets NEMA 4X/IP65 requirements when properly installed. The unit is intended to be mounted into an enclosed panel. Prepare the panel cutout to the dimensions shown. Remove the panel latch from the unit. Slide the panel gasket to the dimensions shown. Remove the panel latch from the unit. Slide the panel gasket over the rear of the unit to the back of the bezel. The unit should be installed fully assembled. Insert the unit into the panel cutout.

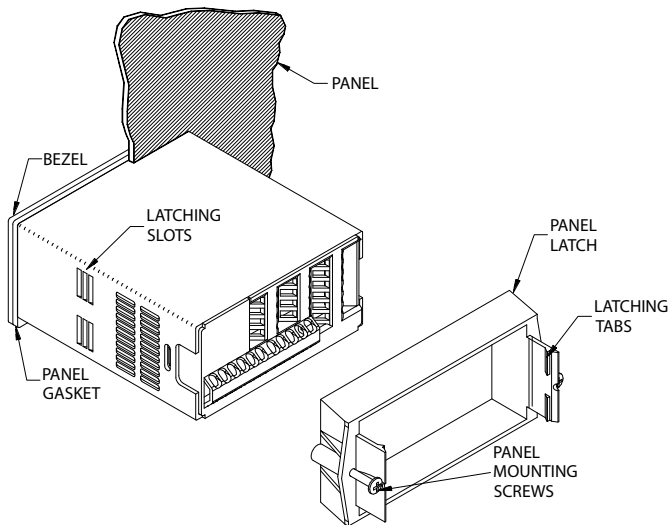

While holding the unit in place, push the panel latch over the rear of the unit so that the tabs of the panel latch engage in the slots on the case. The panel latch should be engaged in the farthest forward slot possible. To achieve a proper seal, tighten the latch screws evenly until the unit is snug in the panel (Torque to approximately 7 in-lbs [79N-cm]). Do not over-tighten the screws.

Installation Environment

The unit should be installed in a location that does not exceed the maximum operating temperature and provides good air circulation. Placing the unit near devices that generate excessive heat should be avoided.

The bezel should be cleaned only with a soft cloth and neutral soap product. Do NOT use solvents. Continuous exposure to direct sunlight may accelerate the aging process of the bezel.

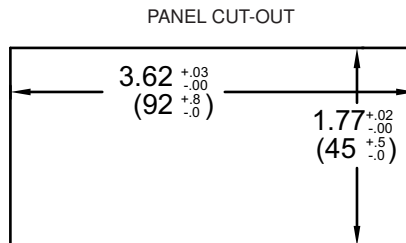

2.0 SETTING THE SWITCHES AND JUMPERS

The meter has switches that must be checked and/or changed prior to applying power. To access the switches, remove the meter base from the case by firmly squeezing and pulling back on the side rear finger tabs. This should lower the latch below the case slot (which is located just in front of the finger tabs). It is recommended to release the latch on one side, then start the other side latch.

Excitation Range Jumper

A jumper is used for selection of the 5 or 10 volt range. It is important that only one jumper position is used at a time.

Set-Up DIP Switches

Two banks of DIP switches are located inside the meter. The 9 position bank of switches is used for calibrating the meter. The values of these switches is discussed in section 5.0 Calibrating the Meter.

The bank of 4 switches located near the front display are used for the selection of decimal points and backlight annunciator. Selecting "ON" position enables the function.

SWITCH	FUNCTION
1	Decimal Point 1 (000.0)
2	Decimal Point 2 (00.00)
3	Decimal Point 3 (0.000)
4	Backlight Annunciator for Units Label

PAXLSG Jumper Selection

JUMPER SELECTIONS
The indicates factory setting.

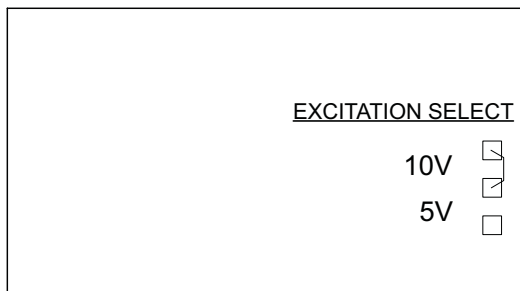

↓ REAR TERMINALS ↓

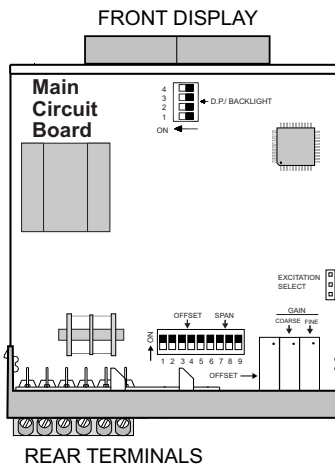

3.0 WIRING THE METER

WIRING OVERVIEW

Electrical connections are made via screw-clamp terminals located on the back of the meter. All conductors should conform to the meter's voltage and current ratings. All cabling should conform to appropriate standards of good installation, local codes and regulations. It is recommended that power supplied to the meter (AC) be protected by a fuse or circuit breaker.

When wiring the meter, compare the numbers embossed on the back of the meter case against those shown in wiring drawings for proper wire position. Strip the wire, leaving approximately 0.3" (7.5 mm) bare lead exposed (stranded wires should be tinned with solder). Insert the lead under the correct screw-clamp terminal and tighten until the wire is secure. (Pull wire to verify tightness.)

EMC INSTALLATION GUIDELINES

Although this meter is designed with a high degree of immunity to Electro-Magnetic Interference (EMI), proper installation and wiring methods must be followed to ensure compatibility in each application. The type of the electrical noise, its source or the method of coupling into the unit may be different for various installations. Listed below are some EMC guidelines for successful installation in an industrial environment.

1. The meter should be mounted in a metal enclosure, which is properly connected to protective earth.
2. Never run Signal or Control cables in the same conduit or raceway with AC power lines, conductors feeding motors, solenoids, SCR controls, and heaters, etc. The cables should be run in metal conduit that is properly grounded. This is especially useful in applications where cable runs are long

and portable two-way radios are used in close proximity or if the installation is near a commercial radio transmitter.

3. Signal or Control cables within an enclosure should be routed as far away as possible from contactors, control relays, transformers, and other noisy components.
4. In extremely high EMI environments, the use of external EMI suppression devices, such as ferrite suppression cores, is effective. Install them on Signal and Control cables as close to the unit as possible. Loop the cable through the core several times or use multiple cores on each cable for additional protection. Install line filters on the power input cable to the unit to suppress power line interference. Install them near the power entry point of the enclosure. The following EMI suppression devices (or equivalent) are recommended:

Ferrite Suppression Cores for signal and control cables:

Fair-Rite # 0443167251 (RLC #FCOR0000)

TDK # ZCAT3035-1330A

Steward #28B2029-0A0

Line Filters for input power cables:

Schaffner # FN2010-1/07 (RLC #LFIL0000)

Schaffner # FN670-1.8/07

Corcom #1VR3

Note: Reference manufacturer's instructions when installing a line filter.

5. Long cable runs are more susceptible to EMI pickup than short cable runs. Therefore, keep cable runs as short as possible.
6. Switching of inductive loads produces high EMI. Use of snubbers across inductive loads suppresses EMI.
Snubber: RLC#SNUB0000.

3.1 POWER WIRING

AC Power

Terminal 1: VAC

Terminal 2: VAC

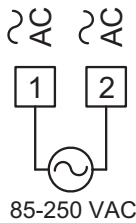

Excitation Power

Terminal 3: Common

Terminal 4: Excitation +

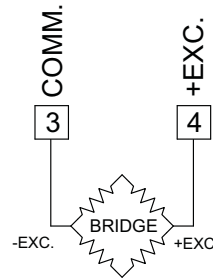

5 VDC @ 60 mA max, ±2%

10 VDC @ 120 mA max, ±2%

3.2 INPUT SIGNAL WIRING

2-Wire Single Ended Input

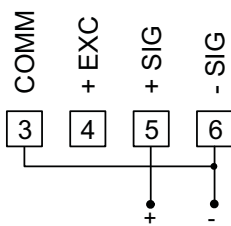

4-Wire Bridge Input

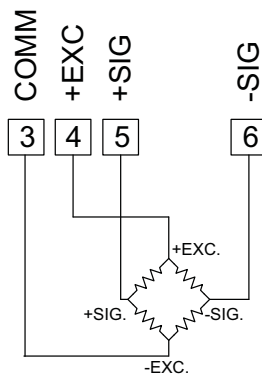

6-Wire Bridge Input

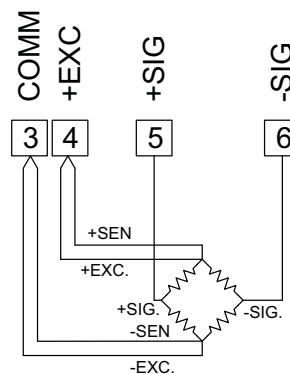

DEADLOAD COMPENSATION

In some cases, the combined deadload and liveload output may exceed the range of the input. To use this range, the output of the bridge can be offset a small amount by applying a fixed resistor across one arm of the bridge. This shifts the electrical output of the bridge downward to within the operating range of the meter. A 100 K ohm fixed resistor shifts the bridge output approximately -10 mV (350 ohm bridge, 10 V excitation).

Connect the resistor between +SIG and -SIG. Use a metal film resistor with a low temperature coefficient of resistance.

BRIDGE COMPLETION RESISTORS

For single strain gage applications, bridge completion resistors must be employed externally to the meter. Only use metal film resistors with a low temperature coefficient of resistance.

Load cells and pressure transducers are normally implemented as full resistance bridges and do not require bridge completion resistors.

4.0 SCALING THE METER

PAXLSG SCHEMATIC

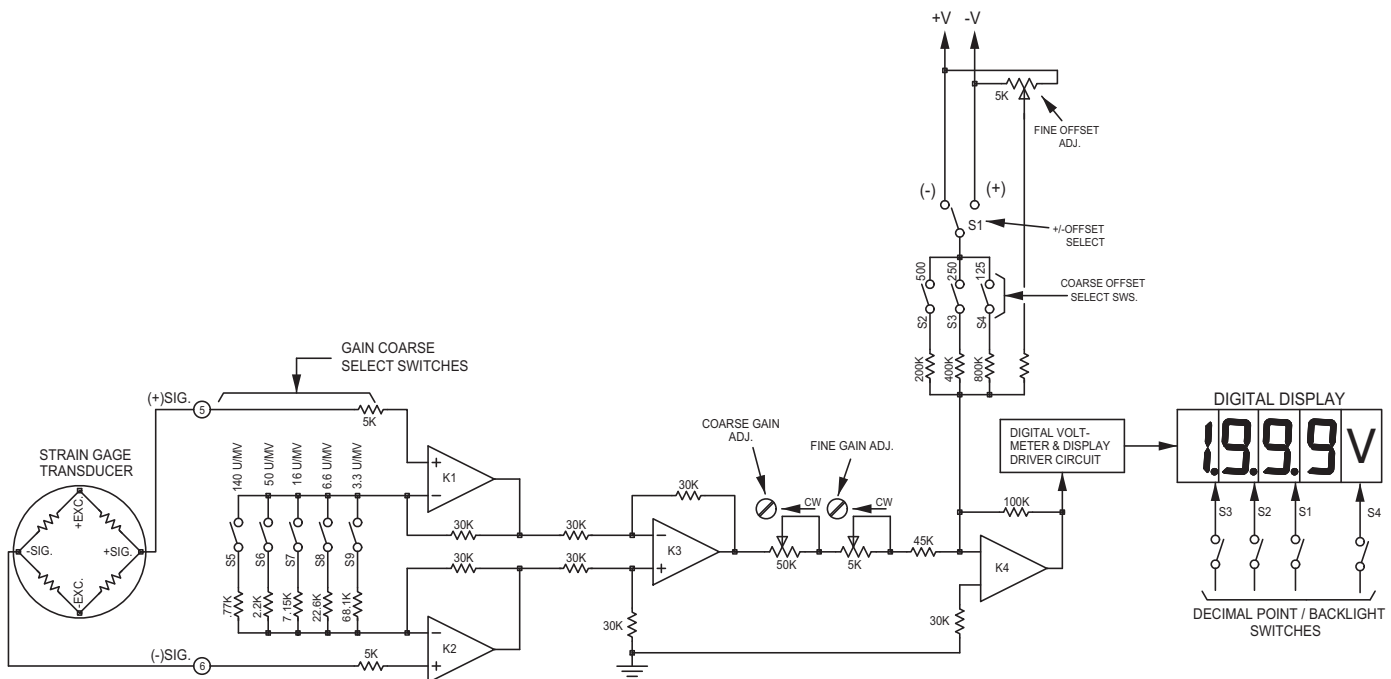

DESCRIPTION OF OPERATION

The Pax Lite Strain Gage Indicator (PAXLSG) consists of a digital voltmeter combined with a high-gain, differential input amplifier that has provision for wide range scaling adjustment (shown above). The unit also incorporates an excitation power supply (5 or 10 VDC) that delivers up to 120 mA. In the simplified schematic above, K1, K2, and K3 form a high-gain, high-stability, differential input preamplifier with a single ended output. The gain of this preamplifier is set up by coarse gain select switches S5 through S9. These switches can be turned on in combination to provide discrete steps of gain-range adjustment. The output of the preamplifier (K3 output) is applied to the summing amplifier (K4) through coarse and fine adjustable potentiometers. These adjustable potentiometers provide final vernier gain adjustment over a range of slightly more than 2:1. An adjustable offset voltage signal is also added in at the input of K4 for zero-balance or for applications where the transfer curve must be offset from zero.

GAIN ADJUSTMENTS

Gain is defined as the Units of Numerical change seen on the display per mV (millivolt) of input signal change (disregarding display decimal points). In effect, gain determines the slope of the transfer curve and is expressed in Units/mV.

$$\text{GAIN} = \frac{(\text{Max. Num. Readout}) - (\text{Min. Num. Readout})}{(\text{Max. mV Input Sig.}) - (\text{Min. mV Input Sig.})}$$

Note: Disregarded Decimal Points in Readout.

For example, if an PAXLSG is to display 50.0 @ 2 mV (min.) and 169.0 @ 19 mV (max.), the required gain will be:

$$\text{GAIN} = \frac{1690 \text{ Units} - 500 \text{ Units}}{19 \text{ mV} - 2 \text{ mV}} = 70 \text{ Units/mV}$$

Note: Remember, display decimal points are disregarded.

To establish this gain, the settings of the coarse gain select switches must first be determined. These switches establish the maximum end of the 2:1 adjustment range of the coarse and fine vernier gain adjustments.

COARSE GAIN SELECT SWITCHES

Each of the coarse gain select switches is marked with the amount of maximum gain it will contribute when turned on. They are turned on singly or in combination (adding up each of their gain contributions), to arrive at a maximum gain value that is just above the desired gain value. To achieve the desired gain of 70 Units/mV in the example just given, the following switches would be turned on:

$$S6 \text{ (Gain 50)} + S7 \text{ (Gain 16)} + S8 \text{ (Gain 6.6)} = 72.6 \text{ Units/mV}$$

With these switches ON, the coarse and fine vernier adjustments cover a gain range from about 36 Units/mV (½ of max.) to 72.6 Units/mV. The required gain of 70 Units/mV falls within this adjustable range.

COARSE AND FINE GAIN ADJUSTMENTS

Once the gain select switches have been set, the final gain calibration is made with the Coarse and Fine Gain adjustments. Both of these adjustments are 15-Turn, screwdriver adjustable potentiometers that increase gain with clockwise rotation. The Coarse adjustment has a 2:1 range. The Fine adjustment has a range of 5-10% (depending on the setting of the Coarse adjustment). Both pots are located at the rear of the meter.

OFFSET ADJUSTMENTS

Offset adjustments move the transfer curve up-and-down along the vertical axis without changing the slope (Gain). They are used to “balance” the output of transducers or to intentionally introduce an offset, such as tare-load compensation. The Fine Offset Adjustment is a 15-turn screwdriver adjustable potentiometer, located at the rear of the meter. It has a range of ±125 Numerical Units of offset which is sufficient for balancing the output of most transducers.

The Coarse Offset Switches (S2, 3, and 4) can be used to add additional steps of offset. Like the coarse gain select switches, the offset switches are marked with the approximate value of offset contributed by each switch, and they can be turned on in combinations with each switch, contributing its value to the total. Switch S1 selects the polarity of the offset signal and can be set to either add or subtract the offset contribution of the switches. The maximum offset that can be obtained with all switches ON and the Fine Offset at its maximum is ±1000, which is one half of the full scale readout.

5.0 CALIBRATING THE METER

There are three different methods that can be used to calibrate the PAXLSG, and the method chosen depends largely on the nature of the application. The three methods are:

VOLTAGE CALIBRATION

In this method, the transducer signal is simply replaced with an accurately measured input voltage that can be varied through the range normally delivered by the transducer (See Voltage Calibration Circuit, below). The PAXLSG is then adjusted to provide the proper readout.

SYSTEM CALIBRATION

In this method, the transducer is connected to the input of the PAXLSG in the final installation, or in a bench set-up simulating the actual installation. Accurately known inputs are then applied to the transducer (i.e. load, pressure, force, etc.), and the PAXLSG adjustments are made to provide the desired indication. This method is usually preferable to the Voltage Calibration method since it calibrates both the transducer and the PAXLSG as a combination, and reduces the inherent risk of inaccuracy or errors accumulated by separate calibration. However, it can only be used in applications where the parameter to be indicated can be easily varied and accurately measured or established. It is also very awkward to use if an offset or transducer unbalance must be dealt with because of Offset/Gain adjustment interaction.

COMBINATION VOLTAGE/SYSTEM CALIBRATION

In applications where tare-load, offset, or substantial transducer unbalance exists and where high accuracy is required in the final indication, it may be desirable to voltage calibrate the unit first to get it very close to its final settings. Then, after final installation, the unit can be "tweaked" to its final settings while using accurately known inputs to the system. These various factors make it impossible to set up one calibration procedure to cover all applications. However, using the following information on Voltage Calibration together with the examples given should provide a good basis for handling virtually any calibration requirement.

CALIBRATION EXAMPLE

"Voltage Calibration" can be easily performed for any application, using the calibration circuit shown below.

VOLTAGE CALIBRATION CIRCUIT (Using 350 Ohm Dummy Bridge)

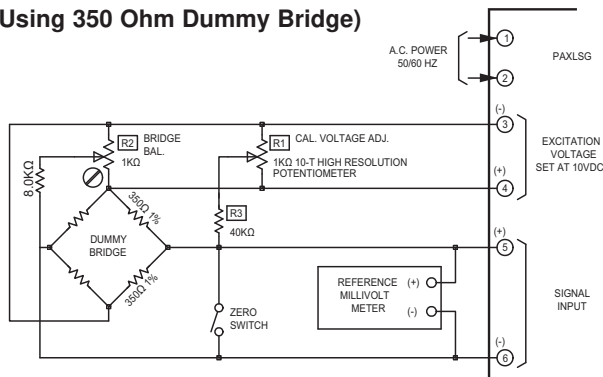

This 350 Ohms "Dummy Bridge" circuit delivers calibration voltages in ranges of 0 to ± 22 mV, 0 to +44 mV, or 0 to -44 mV, depending on the setting of R2. The range can be increased or decreased by adjusting the value of R3 (shown as 40 K). An accurate reference millivoltmeter is used to set up the calibration voltage, and a "Zero Switch" facilitates balancing without readjusting the calibration voltage. High-stability metalized resistors (1% tol.) should be used. The use of a dummy bridge insures a common-mode voltage during calibration that is very similar to that of the actual transducer.

SET-UP:

Before starting the procedure, the Input Swing Voltage (V_s), the Readout Span (R_s) and the required GAIN must be determined.

WHERE:

R_s = (Max. Numerical Display) - (Min. Numerical Display) *Disregard Decimal Points*

V_s = (mV in @ Max. Display) - (mV in @ Min. Display)

$$GAIN = \frac{R_s}{V_s} = \text{Units/mV}$$

EXAMPLE: Readout is to be 5.00 Units @ 2 mV minimum, and 15.00 Units @ 18 mV maximum. The transducer is a 350 Ω strain-gage bridge requiring 10 VDC excitation.

$$R_s = 1500 - 500 = 1000 \text{ Units}$$

$$V_s = 18 \text{ mV} - 2 \text{ mV} = 16 \text{ mV}$$

$$GAIN = \frac{1000}{16} = 62.5 \text{ Units/mV}$$

Note: While most strain gage readout applications are zero-based (i.e. zero readout @ zero input) this example was intentionally chosen because it included an offset reading at zero input. It will be used in the Calibration Procedure below to illustrate the most convenient way to handle offset situations without excessive interaction of gain and offset adjustments. If a zero-based example had been given, the minimum readout and input voltage would have both been zero. R_s and V_s would then simply be the maximum values of readout and input voltage respectively, gain would just be the ratio of (Max. Readout/Max. Input mV), and Steps 7 and 8 of the procedure below could be eliminated.

CALIBRATION PROCEDURE

1. Set the Coarse Gain Select Switches, S5 through S9 to establish a maximum range just exceeding the required gain. Referring to the example given, the required gain was calculated to be 62.5 Units/mV. Setting switches S6 and S7 ON gives $50 + 16 = 66$ Units/mV, which is just above the required amount. The following chart gives an approximate gain adjustment value for each switch:

SWITCH NUMBER	SPAN VALUE
5	140
6	50
7	16
8	6.6
9	3.3

All offset switches, S2, 3, and 4, should be off.

2. Connect the unit to the Calibration Circuit as shown. Set the excitation voltage range jumper to the 10 V position.
3. Place unit in the case and turn power on to the unit. Allow 10 minutes of warm-up time for stabilization.
4. Close the "Zero Switch" of the calibration circuit to obtain zero input voltage. Adjust the fine offset control to get a zero readout.
5. Open the "Zero Switch" of the calibrating circuit and set the input voltage to the calculated swing voltage, V_s . (V_s is 16 mV in the example given.) Now, adjust the Gain Coarse and Fine Controls to get a readout equal to the Readout Span. ($R_s = 1000$ Units in the example given.)
6. Repeat Step 4 and readjust zero if required. If zero readjustment was needed, repeat Step 5, then back to Step 4, etc., until Zero and R_s readings are acceptable.

*7. Set the calibration voltage to the minimum input level (2 mV in this example). Record the meter reading (125 in this example). Power the meter down and remove it from the case. Set the Coarse Offset Select Switches to get the corresponding minimum readout (add the switch offset value(s) to the recorded meter reading). In the example given, the minimum readout was 500 units @ 2 mV, therefore setting switches 3 and 4 gives us 125 (meter reading) + 125 (SW4) + 250 (SW3) = 500. The following chart gives an approximate offset adjustment value for each switch.

SWITCH NUMBER	OFFSET VALUE
2	500
3	250
4	125

- *8. Place unit in the case and turn power on to the unit. Use the fine offset adjustment to fine tune the desired minimum reading (500 in this example). Vary the input from the minimum to maximum levels and check the corresponding readouts. Fine-tune if necessary by readjusting the fine gain adjustment at the maximum end and the fine offset adjustment at the minimum end. (In the example, readout is 500 @ 2 mV min. and 1500 @ 18 mV max.) Alternate between minimum and maximum inputs as required until readout is within desired tolerance at the extremes.
9. Set appropriate decimal point switch (S2 for the example given).

The unit is now ready for installation.

* Steps 7 and 8 are not required in zero-based applications.

6.0 APPLICATIONS

EXAMPLE #1 PRESSURE READOUT & SYSTEM CALIBRATION

This illustration depicts a common application using a PAXLSG with a strain-gage pressure transducer for pressure indication. The gain required to display 150 Units @ 20 mV is 150/20, or 7.5 Units/mV. Setting the Coarse Gain Select Switches S8 and S9 ON, gives a gain range of 6.6 + 3.3, or 9.9 Units/mV maximum, which brackets the required gain. The transducer curve is zero-based (*i.e. zero readout at zero input*), and can be easily System Calibrated. A variable pressure input is applied to the transducer with a "Dead-Weight Tester" and the Fine Offset is adjusted to give a readout of zero with no pressure applied. Then 150 PSI is applied, the Coarse and Fine Gain controls are adjusted for a readout of 150. Pressure is removed, zero is checked and readjusted with the Fine Offset control if needed. Pressure is varied between zero and maximum, with the Fine Gain and Offset adjustments retrimmed as needed until the readout is within tolerance.

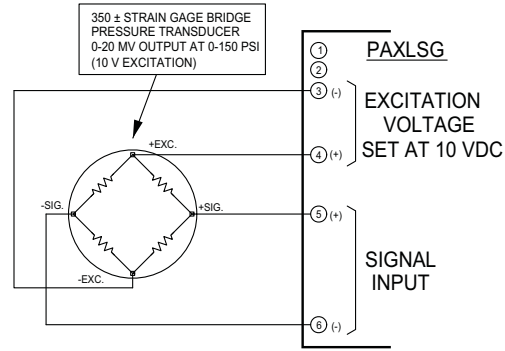

EXAMPLE #2 THE MODEL PAXLSG AS A MILLIVOLT METER

The PAXLSG can be used as a scaleable millivolt meter and will accept either single-ended or differential inputs when connected as shown. Input signals are referenced to the negative (common) side of the excitation supply (Terminal 3). Maximum common-mode voltage (for differential input) is 0 to +7 VDC.

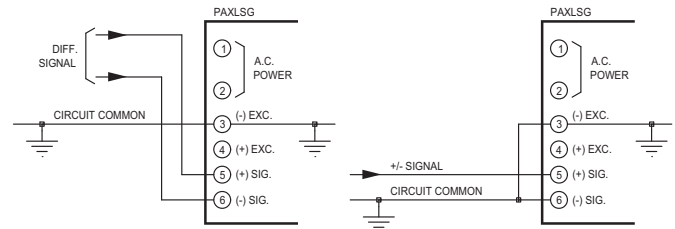

EXAMPLE #3 MULTIPLE LOAD-CELL INPUT, AVERAGE READING

The 120 mA excitation output capability of the PAXLSG allows it to operate multiple strain gage bridges. In this example, it is used to indicate the quantity of granular material held in a hopper that is supported by three load cells in a tripod mounting arrangement. The tare-weight of the empty hopper is about 30% of the full weight, requiring a significant offset for a zero readout when empty. The PAXLSG is first Voltage-Calibrated (*using the known output of the load cells at the empty and full conditions*). Then the unit is installed and fine trimmed (System Calibration) using known loads.

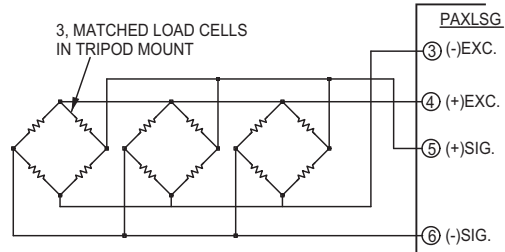

LIMITED WARRANTY

The Company warrants the products it manufactures against defects in materials and workmanship for a period limited to two years from the date of shipment, provided the products have been stored, handled, installed, and used under proper conditions. The Company's liability under this limited warranty shall extend only to the repair or replacement of a defective product, at The Company's option. The Company disclaims all liability for any affirmation, promise or representation with respect to the products.

The customer agrees to hold Red Lion Controls harmless from, defend, and indemnify RLC against damages, claims, and expenses arising out of subsequent sales of RLC products or products containing components manufactured by RLC and based upon personal injuries, deaths, property damage, lost profits, and other matters which Buyer, its employees, or sub-contractors are or may be to any extent liable, including without limitation penalties imposed by the Consumer Product Safety Act (P.L. 92-573) and liability imposed upon any person pursuant to the Magnuson-Moss Warranty Act (P.L. 93-637), as now in effect or as amended hereafter.

No warranties expressed or implied are created with respect to The Company's products except those expressly contained herein. The Customer acknowledges the disclaimers and limitations contained herein and relies on no other warranties or affirmations.

Red Lion Controls
Headquarters
20 Willow Springs Circle
York PA 17406
Tel + 1 (717) 767-6511
Fax + 1 (717) 764-0839

Red Lion Controls
Europe
Printerweg 10
NL - 3821 AD Amersfoort
Tel + 31 (0) 334 723 225
Fax + 31 (0) 334 893 793

Red Lion Controls
India
54, Vishvas Tenement
GST Road, New Ranip,
Ahmedabad-382480 Gujarat, India
Tel + 91 987 954 0503
Fax + 91 79 275 31 350

Red Lion Controls
China
Unit 101, XinAn Plaza
Building 13, No.99 Tianzhou Road
ShangHai, P.R. China 200223
Tel + 86 21 6113-3688
Fax + 86 21 6113-3683