



Chipsmall Limited consists of a professional team with an average of over 10 year of expertise in the distribution of electronic components. Based in Hongkong, we have already established firm and mutual-benefit business relationships with customers from,Europe,America and south Asia,supplying obsolete and hard-to-find components to meet their specific needs.

With the principle of "Quality Parts,Customers Priority,Honest Operation,and Considerate Service",our business mainly focus on the distribution of electronic components. Line cards we deal with include Microchip,ALPS,ROHM,Xilinx,Pulse,ON,Everlight and Freescale. Main products comprise IC,Modules,Potentiometer,IC Socket,Relay,Connector.Our parts cover such applications as commercial,industrial, and automotives areas.

We are looking forward to setting up business relationship with you and hope to provide you with the best service and solution. Let us make a better world for our industry!



Contact us

Tel: +86-755-8981 8866 Fax: +86-755-8427 6832

Email & Skype: info@chipsmall.com Web: www.chipsmall.com

Address: A1208, Overseas Decoration Building, #122 Zhenhua RD., Futian, Shenzhen, China



PC4H520NIP0F

Mini-flat Half-pitch Package Darlington Phototransistor Output High Collector-emitter Voltage Photocoupler



■ Description

PC4H520NIP0F contains a IRED optically coupled to a phototransistor.

It is packaged in a 4-pin Mini-flat, Half pitch type.

Input-output isolation voltage(rms) is 2.5kV.

Collector-emitter voltage is 350V and CTR is MIN. 1000% at input current of 1mA.

■ Features

1. 4-pin Mini-flat Half pitch package (Lead pitch : 1.27mm)
2. Double transfer mold package (Ideal for Flow Soldering)
3. High collector-emitter voltage (V_{CEO} : 350V)
4. Darlington phototransistor output (CTR : MIN.1000% at $I_F=1mA, V_{CE}=2V$)
5. Isolation voltage between input and output ($V_{iso(rms)}$: 2.5kV)
6. Lead-free and RoHS directive compliant

■ Agency approvals/Compliance

1. Recognized by UL1577 (Double protection isolation), file No. E64380 (as model No. **PC4H52**)
2. Package resin : UL flammability grade (94V-0)

■ Applications

1. Modems

Notice The content of data sheet is subject to change without prior notice.

In the absence of confirmation by device specification sheets, SHARP takes no responsibility for any defects that may occur in equipment using any SHARP devices shown in catalogs, data books, etc. Contact SHARP in order to obtain the latest device specification sheets before using any SHARP device.

Internal Connection Diagram

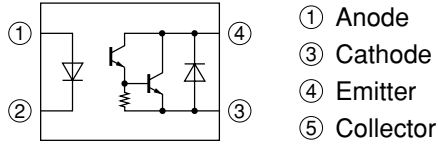

Outline Dimensions

(Unit : mm)

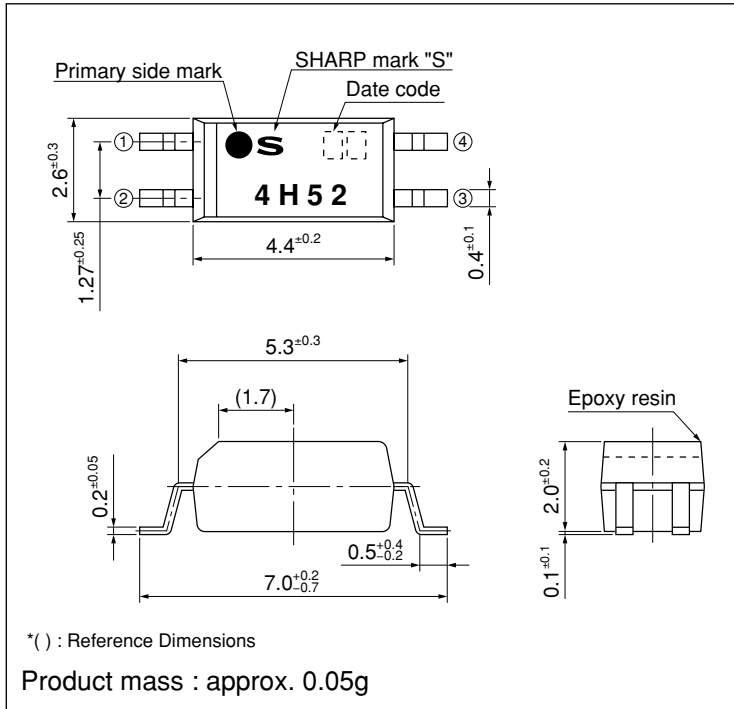

Plating material : SnCu (Cu : TYP. 2%)

Date code (2 digit)

1st digit				2nd digit	
Year of production				Month of production	
A.D.	Mark	A.D	Mark	Month	Mark
1990	A	2002	P	January	1
1991	B	2003	R	February	2
1992	C	2004	S	March	3
1993	D	2005	T	April	4
1994	E	2006	U	May	5
1995	F	2007	V	June	6
1996	H	2008	W	July	7
1997	J	2009	X	August	8
1998	K	2010	A	September	9
1999	L	2011	B	October	O
2000	M	2012	C	November	N
2001	N	∴	∴	December	D

repeats in a 20 year cycle

Country of origin

Japan

Rank mark

There is no rank mark indicator.

■ Absolute Maximum Ratings (T_a=25°C)

	Parameter	Symbol	Rating	Unit
Input	Forward current	I _F	50	mA
	*2 Peak forward current	I _{FM}	1	A
	Reverse voltage	V _R	6	V
	*1 Power dissipation	P	70	mW
Output	Collector-emitter voltage	V _{CEO}	350	V
	Emitter-collector voltage	V _{ECO}	0.1	V
	Collector current	I _C	120	mA
	*1 Collector power dissipation	P _C	180	mW
	*1 Total power dissipation	P _{tot}	210	mW
	Operating temperature	T _{opr}	-40 to +100	°C
	Storage temperature	T _{stg}	-55 to +125	°C
	*3 Isolation voltage	V _{iso (rms)}	2.5	kV
	*4 Soldering temperature	T _{sol}	260	°C

*1 Mounted glass epoxy PCB (Size : 20mm×20mm×1.6mm)

*2 Pulse width≤100μs, Duty ratio : 0.001

*3 40 to 60%RH, AC for 1 minute, f=60Hz

*4 For 10s

■ Electro-optical Characteristics (T_a=25°C)

	Parameter	Symbol	Conditions	MIN.	TYP.	MAX.	Unit
Input	Forward voltage	V _F	I _F =10mA	-	1.2	1.4	V
	Reverse current	I _R	V _R =4V	-	-	10	μA
	Terminal capacitance	C _t	V=0, f=1kHz	-	30	250	pF
Output	Collector dark current	I _{CEO}	V _{CE} =200V, I _F =0	-	-	200	μA
	Collector-emitter breakdown voltage	BV _{CEO}	I _C =0.1mA, I _F =0	350	-	-	V
Transfer characteristics	Current transfer ratio	I _C	I _F =1mA, V _{CE} =2V	10	40	120	mA
	Collector-emitter saturation voltage	V _{CE (sat)}	I _F =20mA, I _C =100mA	-	-	1.4	V
	Isolation resistance	R _{ISO}	DC500V, 40 to 60%RH	5×10 ¹⁰	1×10 ¹¹	-	Ω
	Floating capacitance	C _f	V=0, f=1MHz	-	0.6	1.0	pF
	Cut-off frequency	f _C	V _{CE} =2V, I _C =20mA, R _L =100Ω -3dB	1	7	-	kHz
	Response time	Rise time	t _r	V _{CE} =2V, I _C =20mA, R _L =100Ω	-	100	300
Fall time		t _f	-		20	100	μs

Fig.1 Forward Current vs. Ambient Temperature

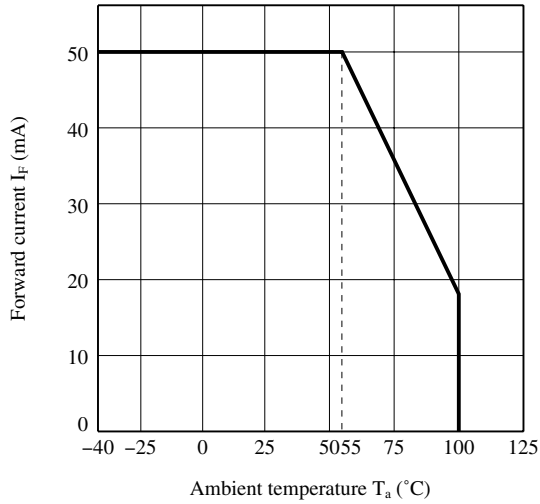

Fig.2 Diode Power Dissipation vs. Ambient Temperature

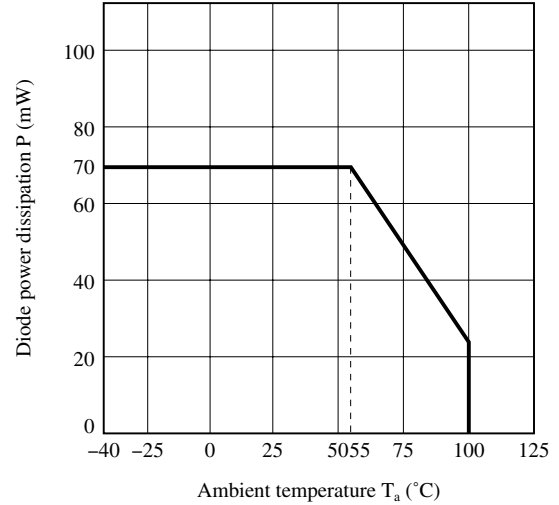

Fig.3 Collector Power Dissipation vs. Ambient Temperature

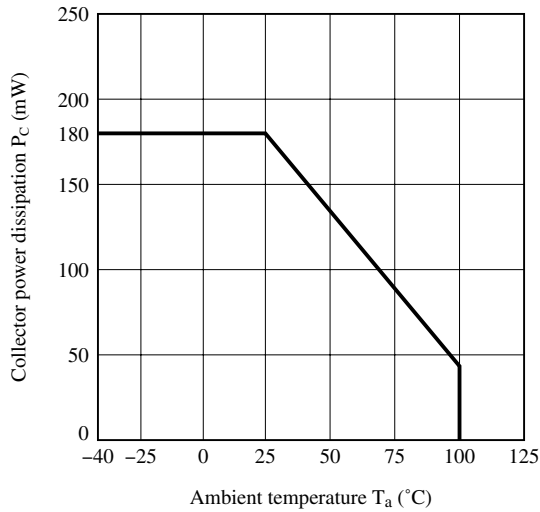

Fig.4 Total Power Dissipation vs. Ambient Temperature

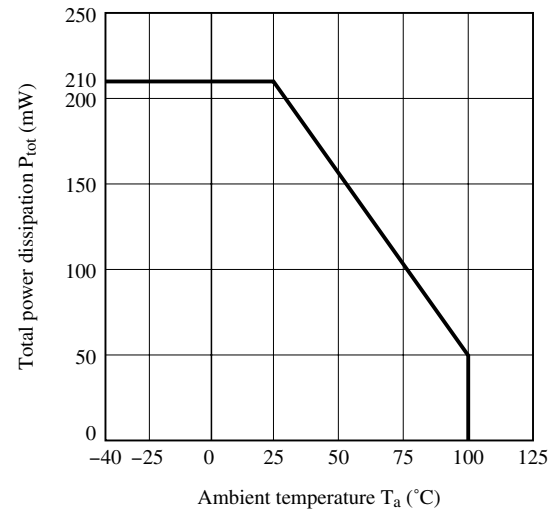

Fig.5 Peak Forward Current vs. Duty Ratio

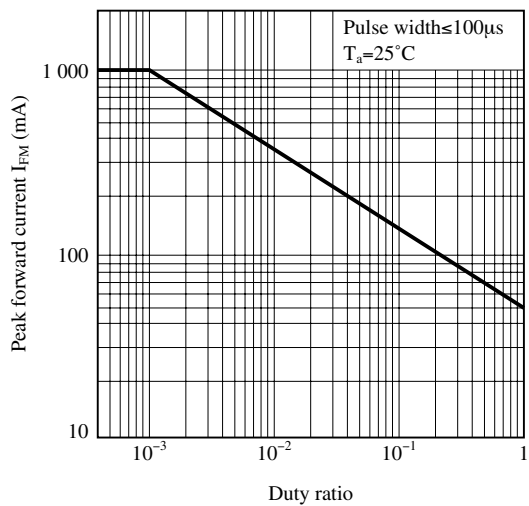

Fig.6 Forward Current vs. Forward Voltage

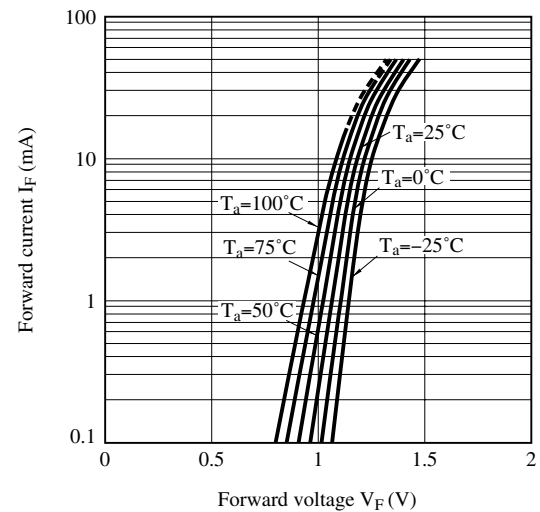

Fig.7 Current Transfer Ratio vs. Forward Current

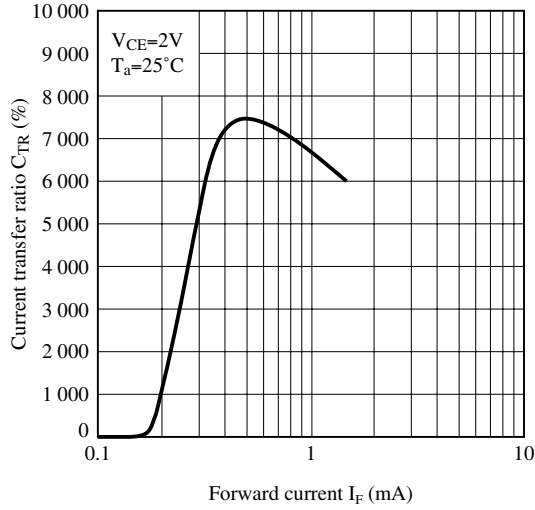

Fig.8 Collector Current vs. Collector-emitter Voltage

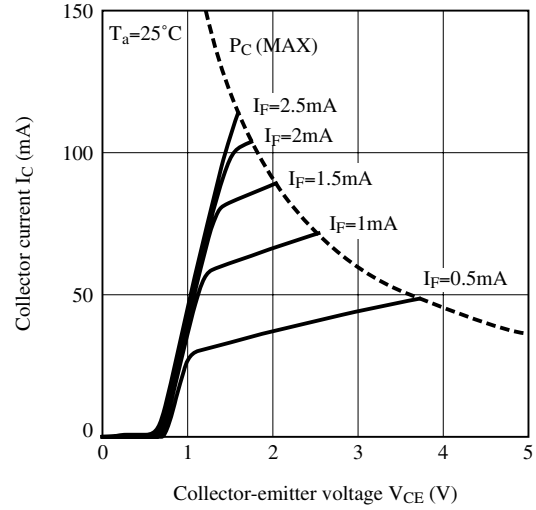

Fig.9 Collector Current vs. Forward Current

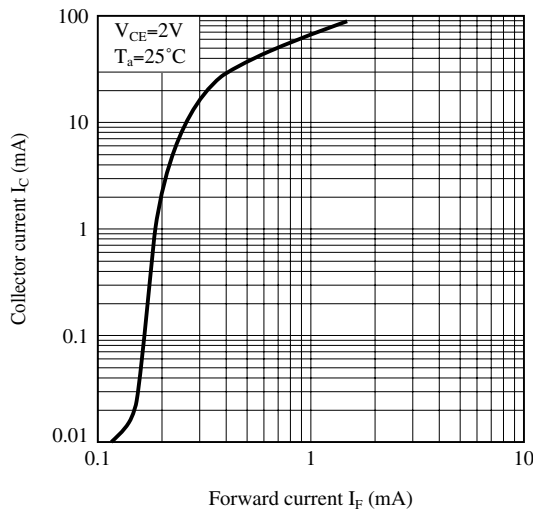

Fig.10 Relative Current Transfer Ratio vs. Ambient Temperature

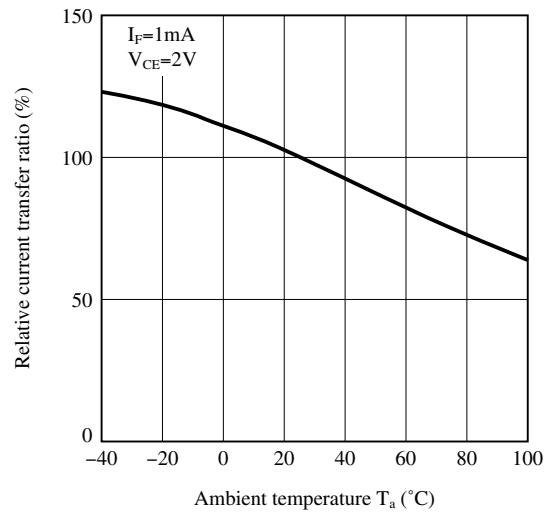

Fig.11 Collector Dark Current vs. Ambient Temperature

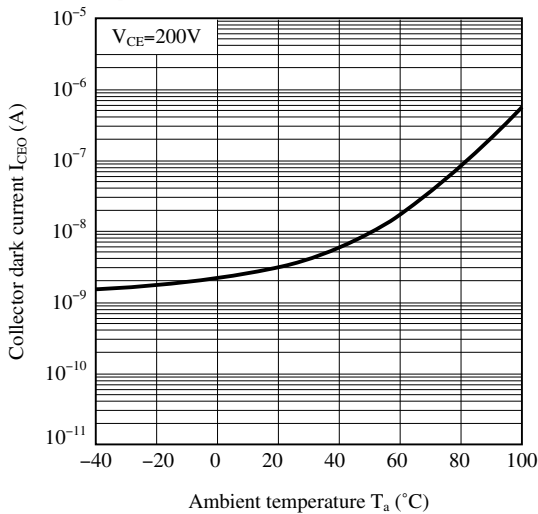

Fig.12 Collector Saturation Voltage vs. Ambient Temperature

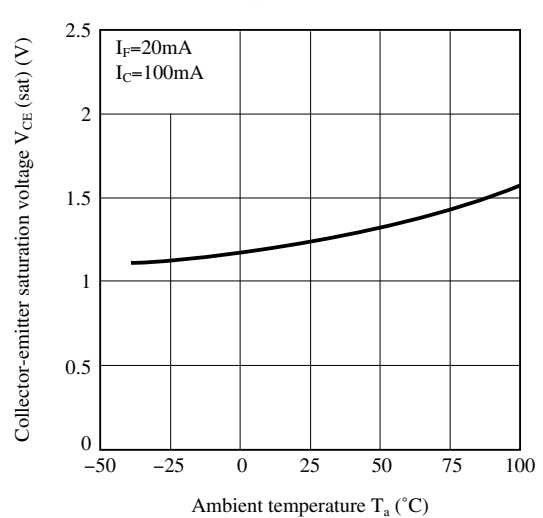

Fig.13 Response Time vs. Load Resistance

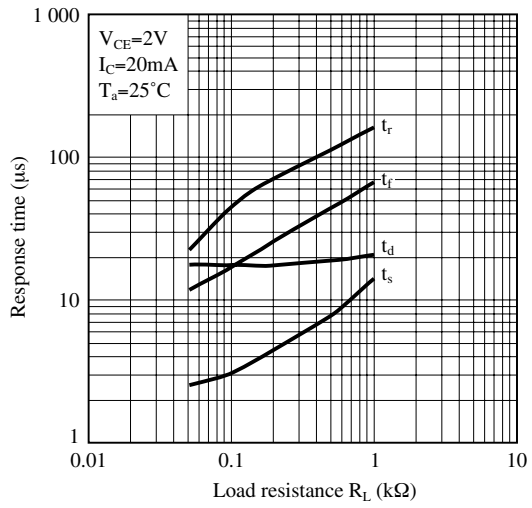
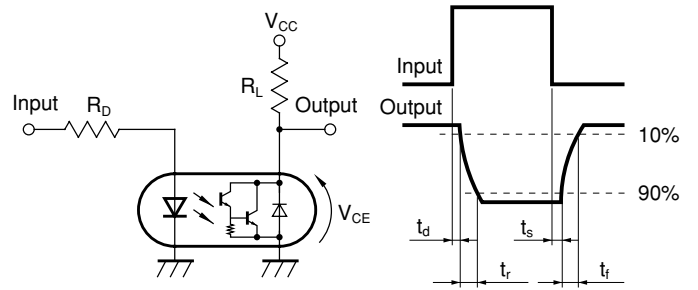

Fig.14 Test Circuit for Response Time



Please refer to the conditions in Fig.13

Remarks : Please be aware that all data in the graph are just for reference and not for guarantee.

■ Design Considerations

● Design guide

While operating at $I_F < 1.0\text{mA}$, CTR variation may increase.
Please make design considering this fact.

This product is not designed against irradiation and incorporates non-coherent IRED.

● Degradation

In general, the emission of the IRED used in photocouplers will degrade over time.

In the case of long term operation, please take the general IRED degradation (50% degradation over 5 years) into the design consideration.

● Recommended Foot Print (reference)

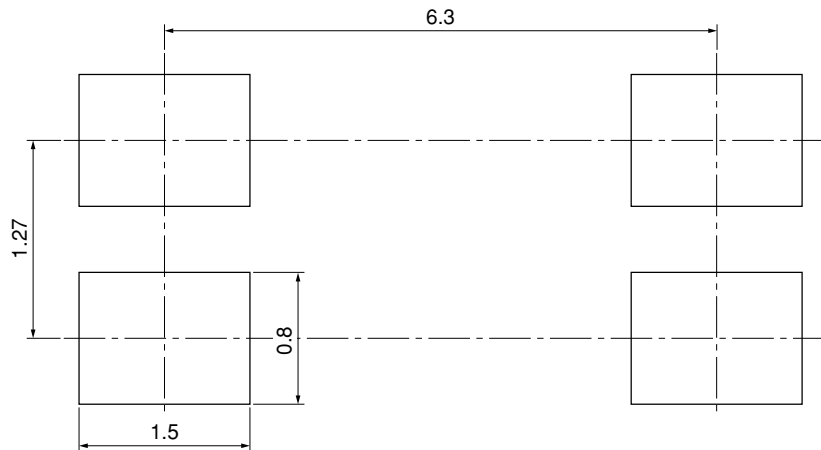

(Unit : mm)

☆ For additional design assistance, please review our corresponding Optoelectronic Application Notes.

■ Manufacturing Guidelines

● Soldering Method

Reflow Soldering:

Reflow soldering should follow the temperature profile shown below.

Soldering should not exceed the curve of temperature profile and time.

Please don't solder more than twice.

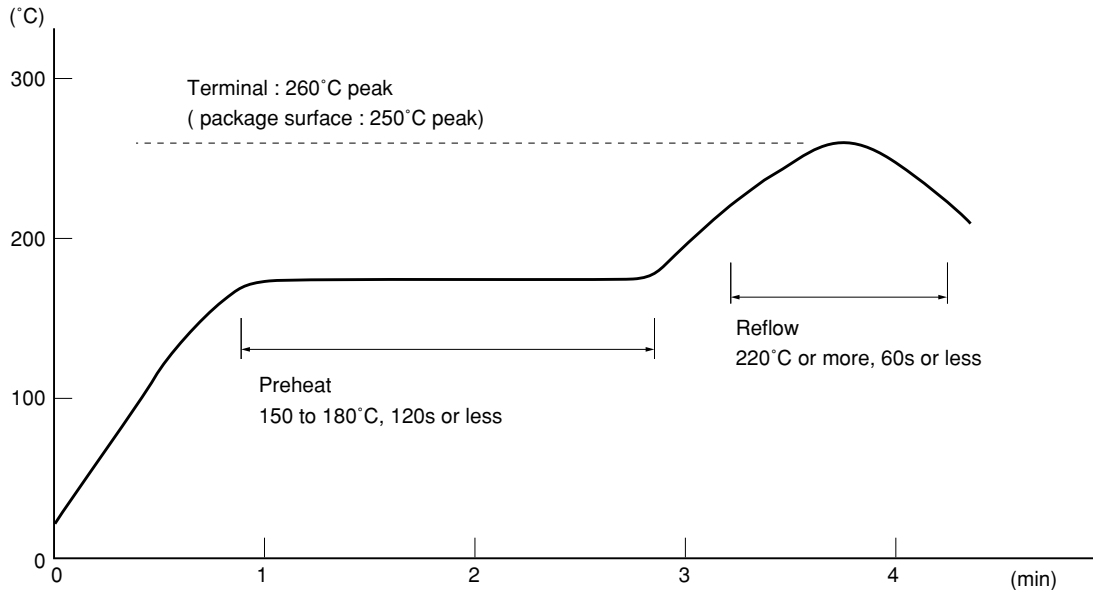

Flow Soldering :

Due to SHARP's double transfer mold construction submersion in flow solder bath is allowed under the below listed guidelines.

Flow soldering should be completed below 260°C and within 10s.

Preheating is within the bounds of 100 to 150°C and 30 to 80s.

Please don't solder more than twice.

Hand soldering

Hand soldering should be completed within 3s when the point of solder iron is below 400°C.

Please don't solder more than twice.

Other notices

Please test the soldering method in actual condition and make sure the soldering works fine, since the impact on the junction between the device and PCB varies depending on the tooling and soldering conditions.

● Cleaning instructions**Solvent cleaning:**

Solvent temperature should be 45°C or below Immersion time should be 3 minutes or less

Ultrasonic cleaning:

The impact on the device varies depending on the size of the cleaning bath, ultrasonic output, cleaning time, size of PCB and mounting method of the device.

Therefore, please make sure the device withstands the ultrasonic cleaning in actual conditions in advance of mass production.

Recommended solvent materials:

Ethyl alcohol, Methyl alcohol and Isopropyl alcohol

In case the other type of solvent materials are intended to be used, please make sure they work fine in actual using conditions since some materials may erode the packaging resin.

● Presence of ODC

This product shall not contain the following materials.

And they are not used in the production process for this product.

Regulation substances : CFCs, Halon, Carbon tetrachloride, 1.1.1-Trichloroethane (Methylchloroform)

Specific brominated flame retardants such as the PBBOs and PBBs are not used in this product at all.

This product shall not contain the following materials banned in the RoHS Directive (2002/95/EC).

- Lead, Mercury, Cadmium, Hexavalent chromium, Polybrominated biphenyls (PBB), Polybrominated diphenyl ethers (PBDE).

■ **Package specification**

● **Tape and Reel package**

Package materials

Carrier tape : PS

Cover tape : PET (three layer system)

Reel : PS

Carrier tape structure and Dimensions

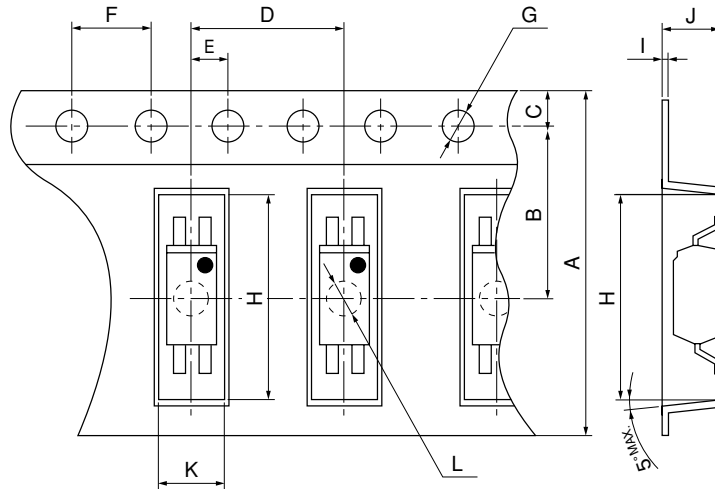

Dimensions List							(Unit : mm)
A	B	C	D	E	F	G	
12.0±0.3	5.5±0.1	1.75±0.1	8.0±0.1	2.0±0.1	4.0±0.1	φ1.5 ^{+0.1} ₀	
H	I	J	K	L			
7.5±0.1	0.3±0.05	2.3±0.1	3.1±0.1	φ1.6 ^{+0.1} ₀			

Reel structure and Dimensions

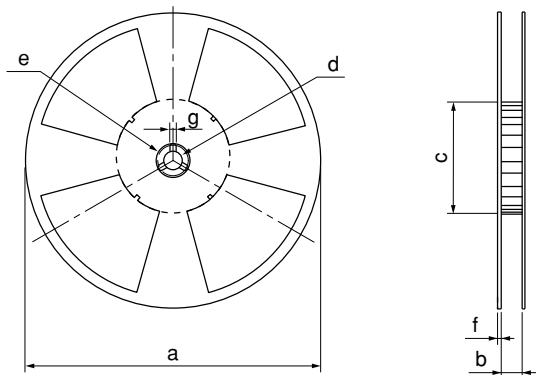

Dimensions List				(Unit : mm)
a	b	c	d	
330	13.5±1.5	100±1.0	13±0.5	
e	f	g		
23±1.0	2.0±0.5	2.0±0.5		

Direction of product insertion

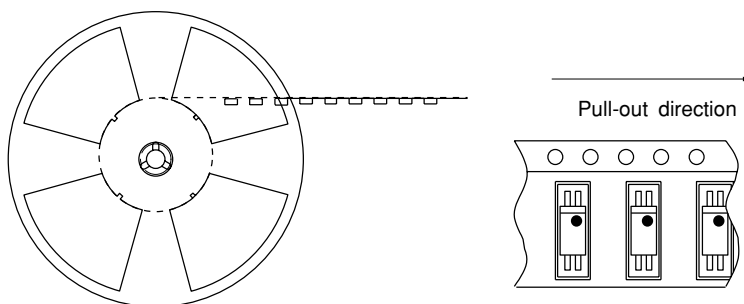

[Packing : 3 000pcs/reel]

■ Important Notices

· The circuit application examples in this publication are provided to explain representative applications of SHARP devices and are not intended to guarantee any circuit design or license any intellectual property rights. SHARP takes no responsibility for any problems related to any intellectual property right of a third party resulting from the use of SHARP's devices.

· Contact SHARP in order to obtain the latest device specification sheets before using any SHARP device. SHARP reserves the right to make changes in the specifications, characteristics, data, materials, structure, and other contents described herein at any time without notice in order to improve design or reliability. Manufacturing locations are also subject to change without notice.

· Observe the following points when using any devices in this publication. SHARP takes no responsibility for damage caused by improper use of the devices which does not meet the conditions and absolute maximum ratings to be used specified in the relevant specification sheet nor meet the following conditions:

(i) The devices in this publication are designed for use in general electronic equipment designs such as:

- Personal computers
- Office automation equipment
- Telecommunication equipment [terminal]
- Test and measurement equipment
- Industrial control
- Audio visual equipment
- Consumer electronics

(ii) Measures such as fail-safe function and redundant design should be taken to ensure reliability and safety when SHARP devices are used for or in connection

with equipment that requires higher reliability such as:

- Transportation control and safety equipment (i.e., aircraft, trains, automobiles, etc.)
- Traffic signals
- Gas leakage sensor breakers
- Alarm equipment
- Various safety devices, etc.

(iii) SHARP devices shall not be used for or in connection with equipment that requires an extremely high level of reliability and safety such as:

- Space applications
- Telecommunication equipment [trunk lines]
- Nuclear power control equipment
- Medical and other life support equipment (e.g., scuba).

· If the SHARP devices listed in this publication fall within the scope of strategic products described in the Foreign Exchange and Foreign Trade Law of Japan, it is necessary to obtain approval to export such SHARP devices.

· This publication is the proprietary product of SHARP and is copyrighted, with all rights reserved. Under the copyright laws, no part of this publication may be reproduced or transmitted in any form or by any means, electronic or mechanical, for any purpose, in whole or in part, without the express written permission of SHARP. Express written permission is also required before any use of this publication may be made by a third party.

· Contact and consult with a SHARP representative if there are any questions about the contents of this publication.