



Chipsmall Limited consists of a professional team with an average of over 10 year of expertise in the distribution of electronic components. Based in Hongkong, we have already established firm and mutual-benefit business relationships with customers from,Europe,America and south Asia,supplying obsolete and hard-to-find components to meet their specific needs.

With the principle of "Quality Parts,Customers Priority,Honest Operation,and Considerate Service",our business mainly focus on the distribution of electronic components. Line cards we deal with include Microchip,ALPS,ROHM,Xilinx,Pulse,ON,Everlight and Freescale. Main products comprise IC,Modules,Potentiometer,IC Socket,Relay,Connector.Our parts cover such applications as commercial,industrial, and automotives areas.

We are looking forward to setting up business relationship with you and hope to provide you with the best service and solution. Let us make a better world for our industry!



Contact us

Tel: +86-755-8981 8866 Fax: +86-755-8427 6832

Email & Skype: info@chipsmall.com Web: www.chipsmall.com

Address: A1208, Overseas Decoration Building, #122 Zhenhua RD., Futian, Shenzhen, China



UM10473

OL2300 Demo board user manual

Rev. 01 — 29 August 2011

User manual

Document information

Info	Content
Keywords	OL2300, User manual, UHF, RF, transmitter, fractional-N-PLL
Abstract	This user manual describes the architecture and functionalities of the OL2300 UHF transmitter evaluation board.



Revision history

Rev	Date	Description
v.1	20110829	initial version

Contact information

For more information, please visit: <http://www.nxp.com>

For sales office addresses, please send an email to: salesaddresses@nxp.com

1. Introduction

OL2300 is a UHF ASK/FSK fractional-N transmitter IC. The device provides a fully integrated fractional-N PLL frequency synthesizer and a power amplifier to drive an external antenna.

The purpose of this manual is to provide an introduction to the evaluation board named "LID1204", which is intended to evaluate the internal functional blocks of the OL2300..

The evaluation board is equipped with a serial RS232 interface to connect the board to a PC. A Windows GUI provides a means to access the different special function registers of OL2300. The onboard controller PCF7941 acts as a logical interface between RS232 and OL2300 and it is programmed accordingly.

The power amplifier output of OL2300 is matched to 50 Ω and can be directly connected to appropriate measurement devices.

The evaluation board is available in two versions; one for the 315 MHz and one for the 434 MHz ISM frequency bands. Each version has a different mounting for the crystal and different matching network of the 50 Ω SMA connector output.

An 868 MHz version can be created by using the 434 MHz board, and changing some of the component values (see [Figure 1](#)).

[Section 2 "Evaluation board schematic"](#) gives details of component placement, usage and typical measurement results.

2. Evaluation board schematic

The schematic of the evaluation board is shown in [Figure 1](#).

The 125 kHz transponder antenna of the PCF7941 and the three switches are not mounted.

The transmitter section of the board is isolated by removing the following six jumpers: TX_SUPPLY, EN, SCK, SDIO, CKOUT, SDO. The jumpers allow the following:

- evaluation of the onboard OL2300 IC in combination with another μC
- monitoring of the SPI connection
- current measurements

The crystal which is connected to the oscillator pins of OL2300 is an NDK NX5032GA. A frequency of 13.28963 MHz is chosen to cover the 434 MHz band as well as the 868 MHz and the 915 MHz bands. However, for the 868 MHz and 915 MHz band, the matching network must be adapted accordingly.

In the 315 MHz version, the crystal frequency is 18.37036 MHz. The reference clock frequency is divided by two to keep the PLL frequency below the specified maximum of 920 MHz. To achieve this frequency limitation, the internal XTAL clock divider is set to $\text{XOSL} = 1$.

The UHF matching network is adapted to transform the $50\ \Omega$ terminated output impedance of connector X2 to the optimal impedance of the RF power amplifier. This is done in a way to attain the highest possible output power in power mode III (PAM=3) with a harmonic suppression of at least $-50\ \text{dBc}$.

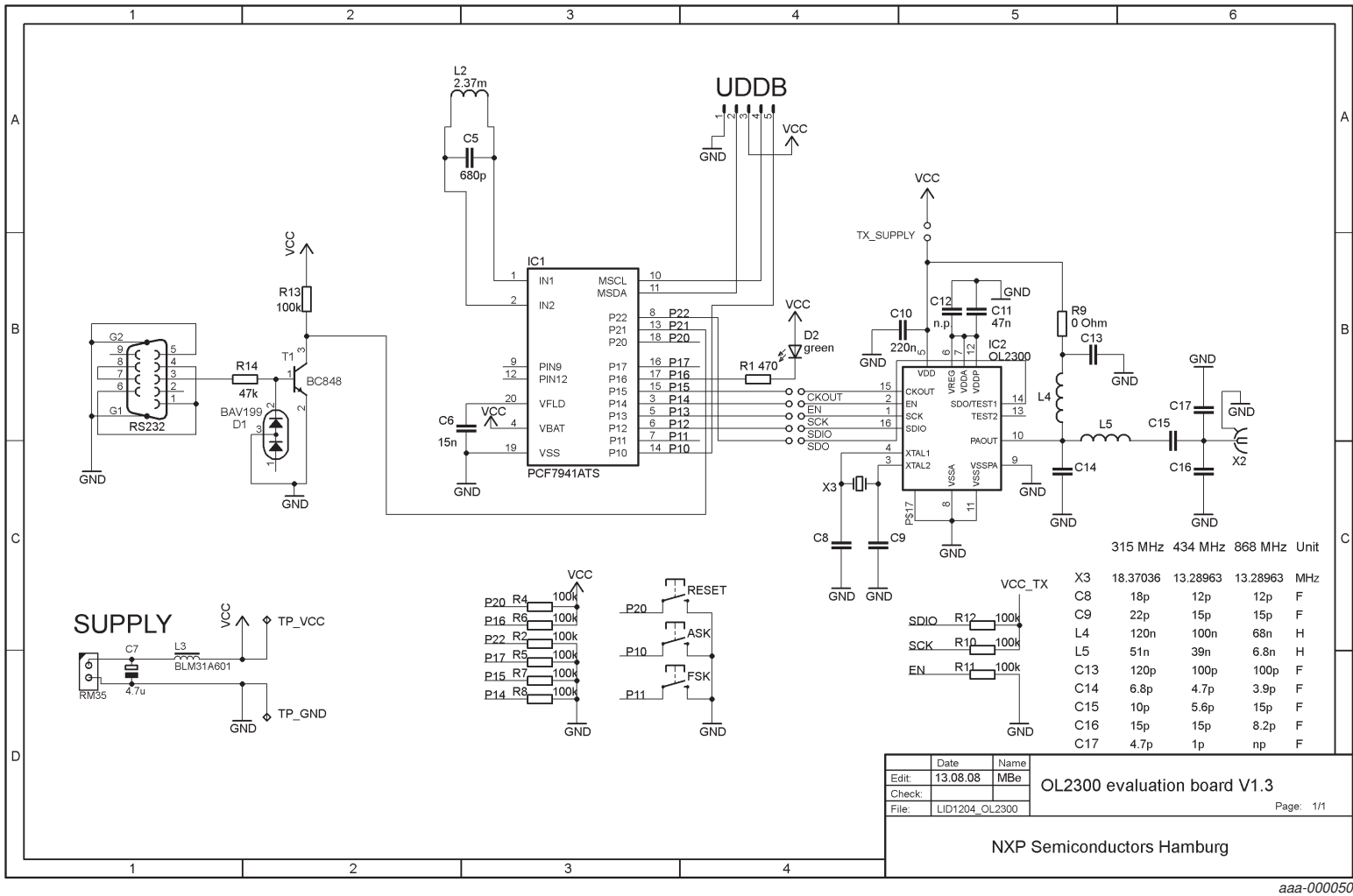

Fig 1. Schematic of OL2300 RF evaluation board

3. Component placement

Figure 2 shows the component layout on the evaluation board as viewed from the top side.

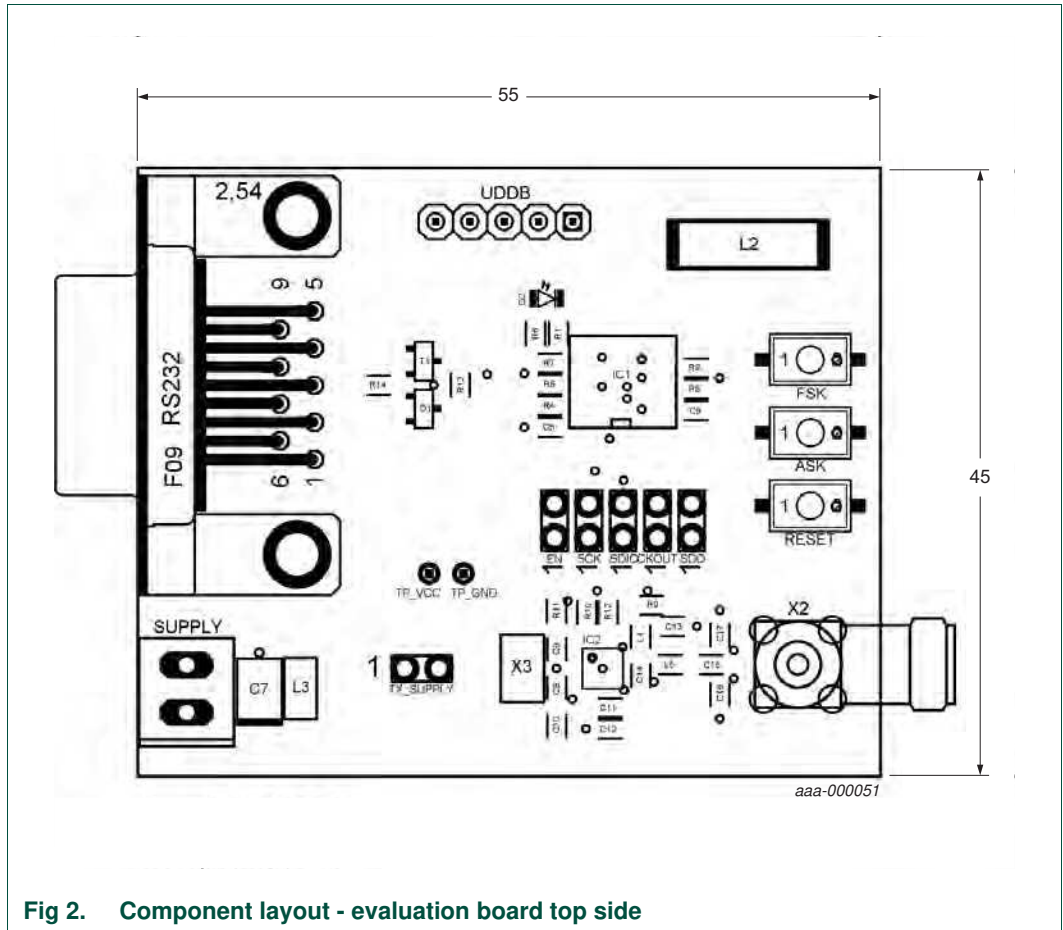

Fig 2. Component layout - evaluation board top side

4. Usage

Connect a supply voltage (2.1 V up to 3.6 V) to the supply connector, according to the indications on the board layout. For safety reasons, the maximum current is limited to 50 mA.

When a serial connection between the evaluation board and a PC is established, the Windows software 'Frantic.exe' can be run. On start-up, the program initializes the special function register set of OL2300 using the first available COM port. The communication port used by the program is shown in the left lower corner of the GUI. Each interaction with the Windows program is immediately transferred to reflect the changes in the register set of OL2300. The Windows program provides context-sensitive help.

A 50 Ω spectrum analyzer is directly connected to X2. Ensure that the analyzer input attenuator setting matches the RF output power level of the evaluation board using a starting reference value of +20 dBm.

5. Measurement results

The evaluation board measurements are made under the following conditions, unless otherwise stated:

- Supply voltage $V_{CC} = 2.7\text{ V}$
- Power mode PAM = 3 with CASC = 0 and ENRAD = 0
- Output amplitude AMH = 15
- Temperature T = room temperature
- Carrier frequency $f_C = 433.92\text{ MHz}$

Detailed measurements have been performed for the 434 MHz version of the evaluation board only.

Measurement instruments:

- Spectrum Analyzer: Rohde & Schwarz FSP7
- Multimeter: Agilent 34401A

The following results indicate typical values only and vary as a result of device spreads, component tolerances or temperature changes.

5.1 General

Table 1. Typical performance

Symbol	Parameter	Conditions	Version (MHz)			Unit
			315	434	868	
I_{pd}	power-down current	-	<10	<10	<10	nA
I_{CC}	supply current	XTAL on	250	250	250	μA
		PLL locked	2.1	2.7	2.7	mA
		PA enabled	12.1	13.5	13	mA
P_o	output power	-	9.8	9.3	8.5	dBm
P_{sp}	spurious output power	reference	-47	-47	-42	dBc
		harmonic	-54	-52	-46	dBc

- Center frequency: 315 MHz
- Data rate: 4.8 kbps Manchester coded (symbol rate = 9600 chips/s)
- Modulation type: FSK
- Frequency deviation: 4.8 kHz

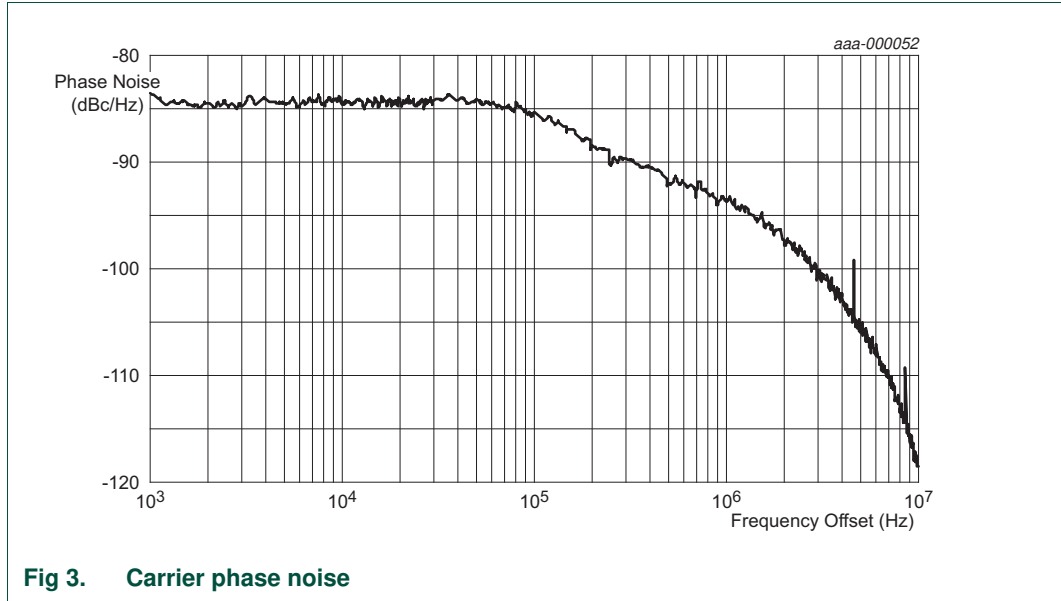

Fig 3. Carrier phase noise

5.2 Output power (P_O)

5.2.1 P_O = f(AMH, PAM)

The data provided in [Table 2](#) is based on the power of the carrier when measured during CW operation.

Table 2. Output power [f(AMH, PAM)]

AMH	P _O (dBm)				I _{CC} (mA)			
	PAM = 0	PAM = 1	PAM = 2	PAM = 3	PAM = 0	PAM = 1	PAM = 2	PAM = 3
0	-75	-75	-75	-75	2.62	2.62	2.62	2.62
1	-21.97	-19.40	-15.20	-10.30	2.86	2.94	3.16	3.66
2	-15.70	-13.14	-8.98	-4.10	3.10	3.27	3.70	4.71
3	-12.14	-9.66	-5.58	-0.76	3.35	3.60	4.24	5.71
4	-9.32	-7.05	-3.12	-1.60	3.60	3.91	4.74	6.66
5	-7.55	-5.25	-1.30	3.35	3.84	4.22	5.25	7.60
6	-6.27	-3.87	0.18	4.77	4.03	4.49	5.73	8.49
7	-4.93	-2.56	1.45	5.84	4.28	4.81	6.23	9.29
8	-3.55	-1.30	2.54	6.64	4.52	5.12	6.71	9.99
9	-2.80	-0.50	3.41	7.27	4.71	5.37	7.15	10.62
10	-2.06	0.30	4.24	7.79	4.89	5.63	7.59	11.21
11	-1.38	1	4.95	8.20	5.09	5.90	8.01	11.72
12	-0.52	1.79	5.63	8.54	5.32	6.19	8.44	12.20
13	0.01	2.34	6.17	8.82	5.51	6.44	8.83	12.63
14	0.41	2.80	6.65	9.06	5.65	6.64	9.18	13.03
15	0.93	3.32	7.09	9.27	5.84	6.90	9.54	13.41

[Figure 4](#) is based on measurement data provided in [Table 2](#)

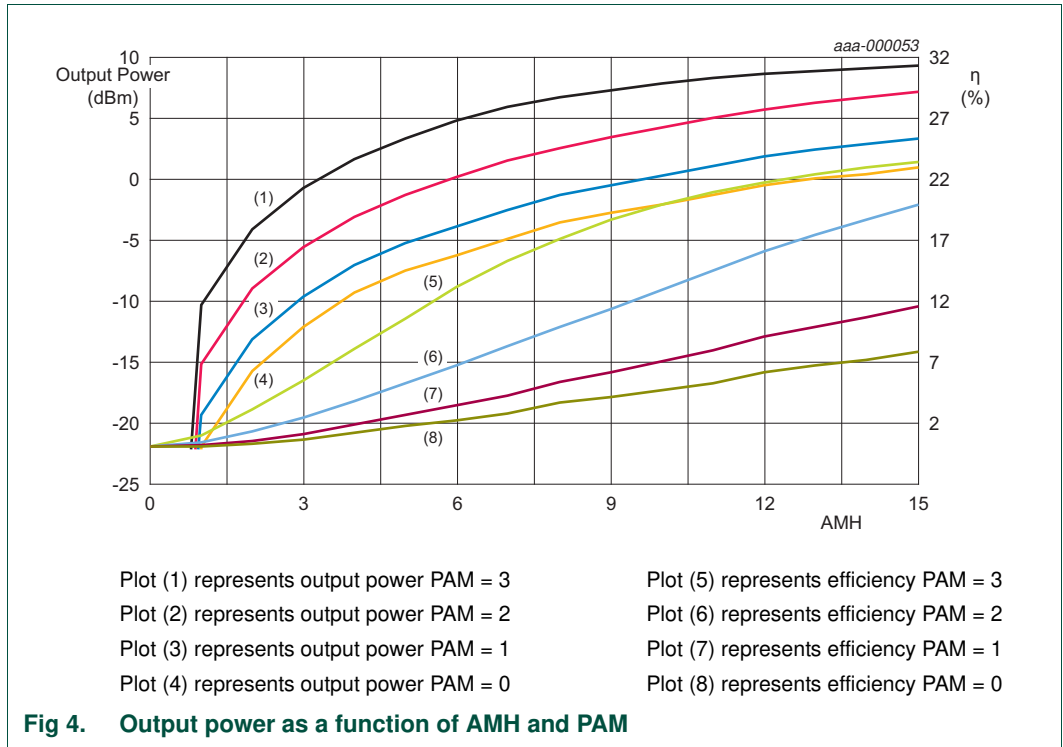

5.2.2 $P_o = f(V_{CC}, CASC, ENRAD)$

Table 3. Output power [f(V_{CC}, CASC, ENRAD)]

V _{CC} (V)	CASC = 0, ENRAD = 0		CASC = 1, ENRAD = 1	
	P _o (dBm)	I _{CC} (mA)	P _o (dBm)	I _{CC} (mA)
2.1	6.86	10.81	6.42	10.01
2.2	7.32	11.30	6.74	10.27
2.3	7.76	11.76	7.04	10.51
2.4	8.17	12.19	7.31	10.74
2.5	8.55	12.61	7.57	10.96
2.6	8.91	13.02	7.80	11.17
2.7	9.25	13.41	8.02	11.37
2.8	9.58	13.78	8.21	11.56
2.9	9.88	14.15	8.39	11.74
3.0	10.17	14.51	8.54	11.90
3.1	10.43	14.82	8.68	12.06
3.2	10.68	15.11	8.80	12.20
3.3	10.91	15.39	8.90	12.33
3.4	11.14	15.65	8.98	12.45
3.5	11.34	15.91	9.06	12.56
3.6	11.54	16.16	9.11	12.66

Figure 5 is based on measurement data provided in Table 3

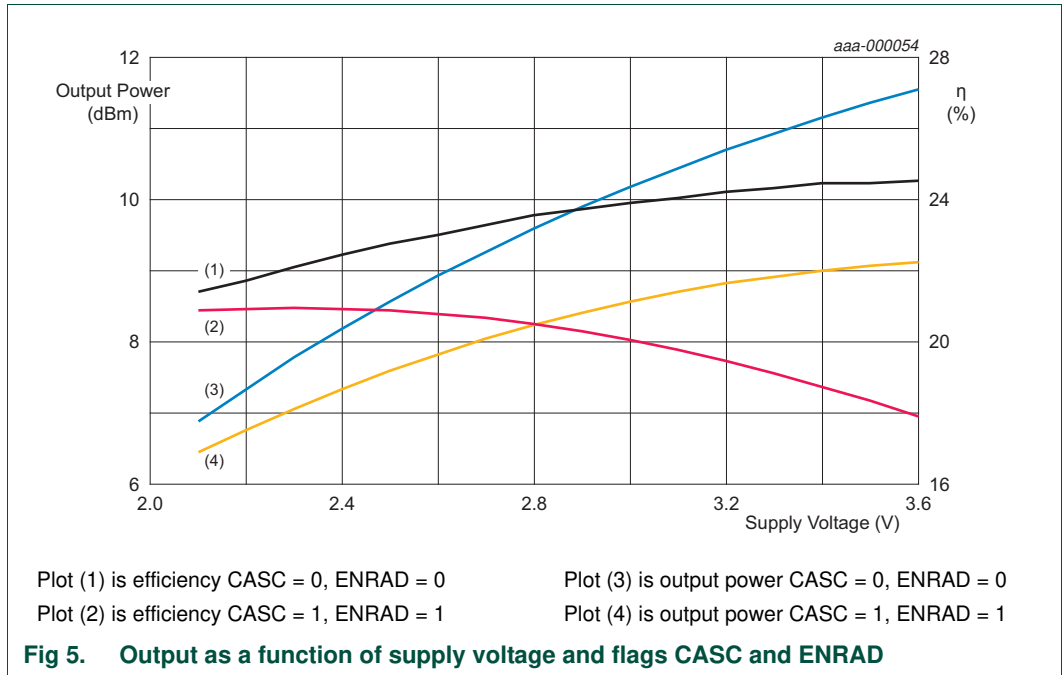

5.3 Output Spectrum

The most significant spurious RF outputs of the OL2300 as measured at the RF output connector are shown in Figure 6 to Figure 9. The spectrum analyzer is connected directly to the evaluation board. The spectrum analyzer settings can be seen. Measurements are made under conditions: CW, VCC = 2.7 V, AMH = 15.

5.3.1 315 MHz

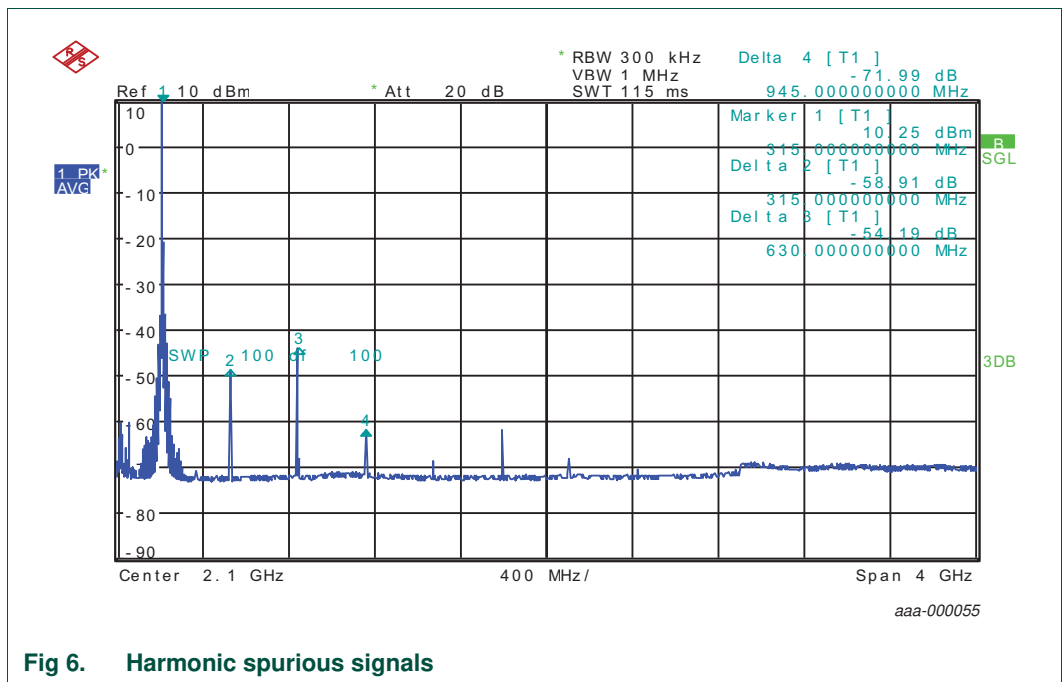

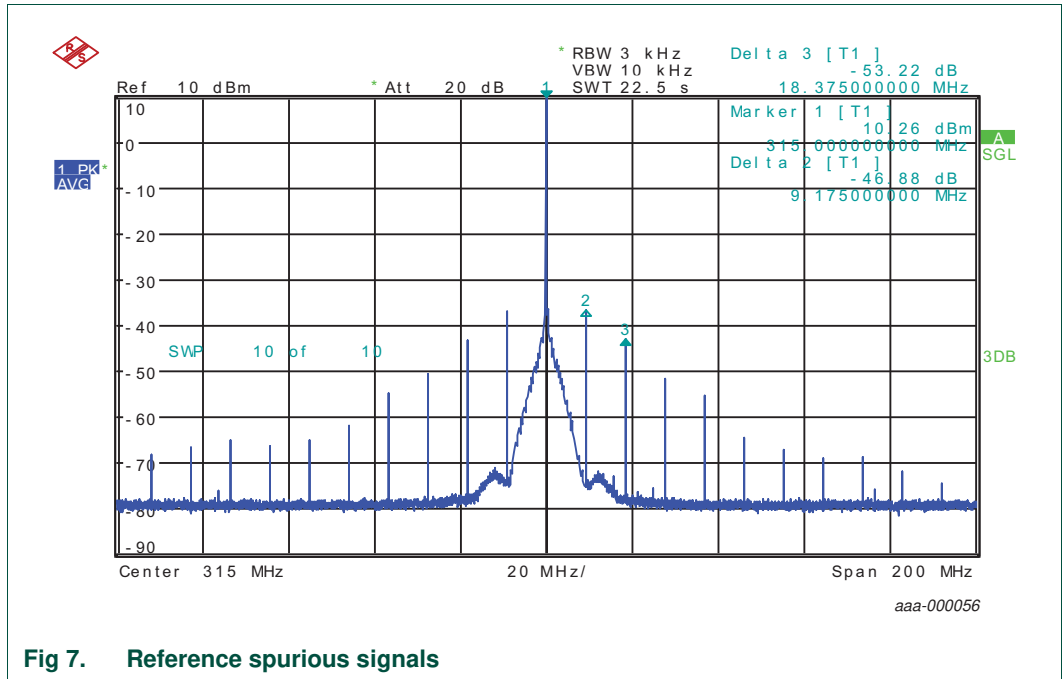

Fig 7. Reference spurious signals

5.3.2 434 MHz

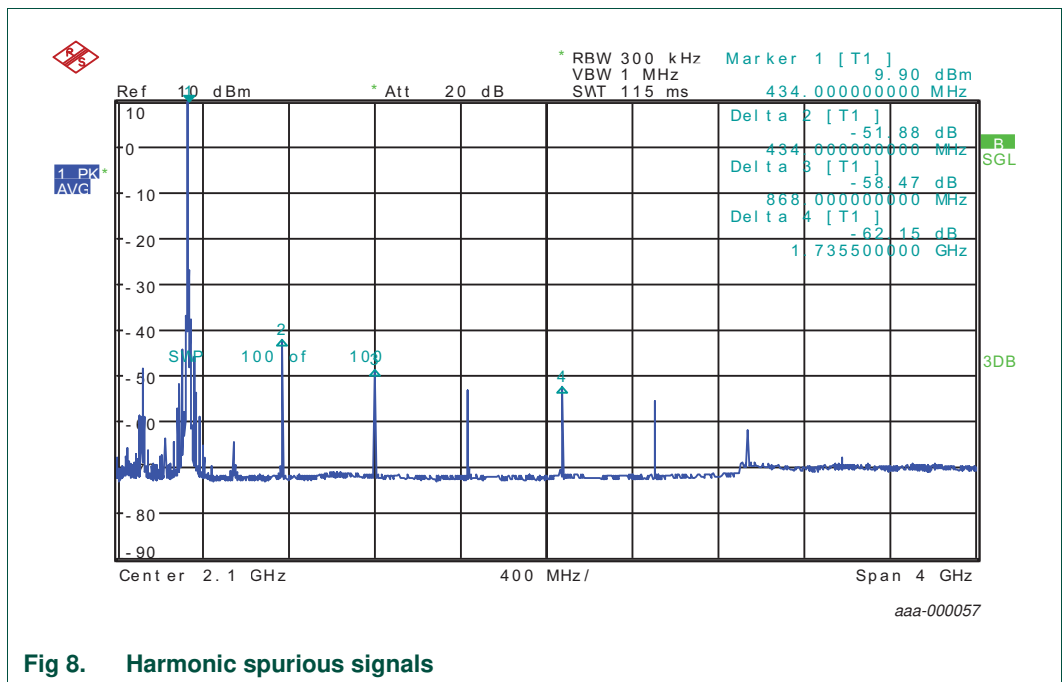
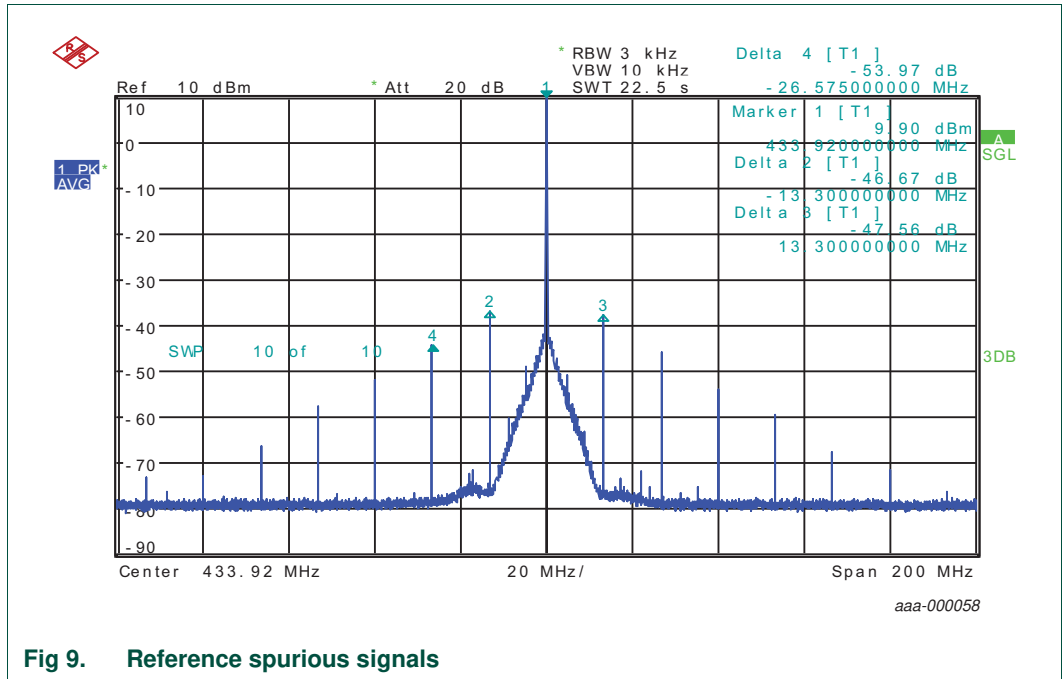

Fig 8. Harmonic spurious signals



5.4 ASK modulation

The output of OL2300, when set to ASK modulation, is measured in frequency and time domain for ASK and Soft-ASK. [Figure 10](#) and [Figure 11](#) show the results.

A modulation frequency of 20 kHz is used for the measurements.

$V_{CC} = 2.7\text{ V}$, $AMH = 15$, $AML = 0$, $RBW = 300\text{ kHz}$

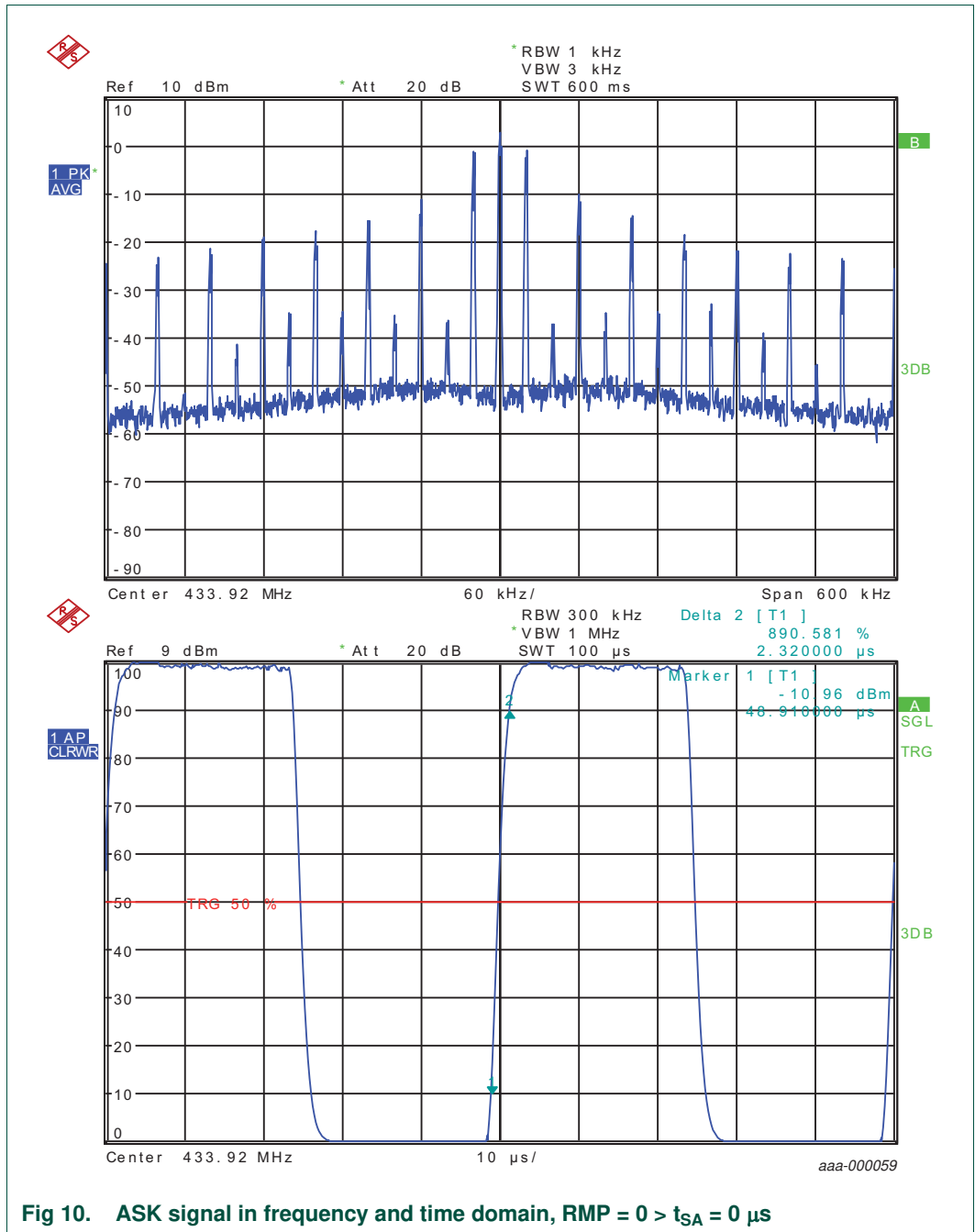

Fig 10. ASK signal in frequency and time domain, $RMP = 0 > t_{SA} = 0\ \mu s$

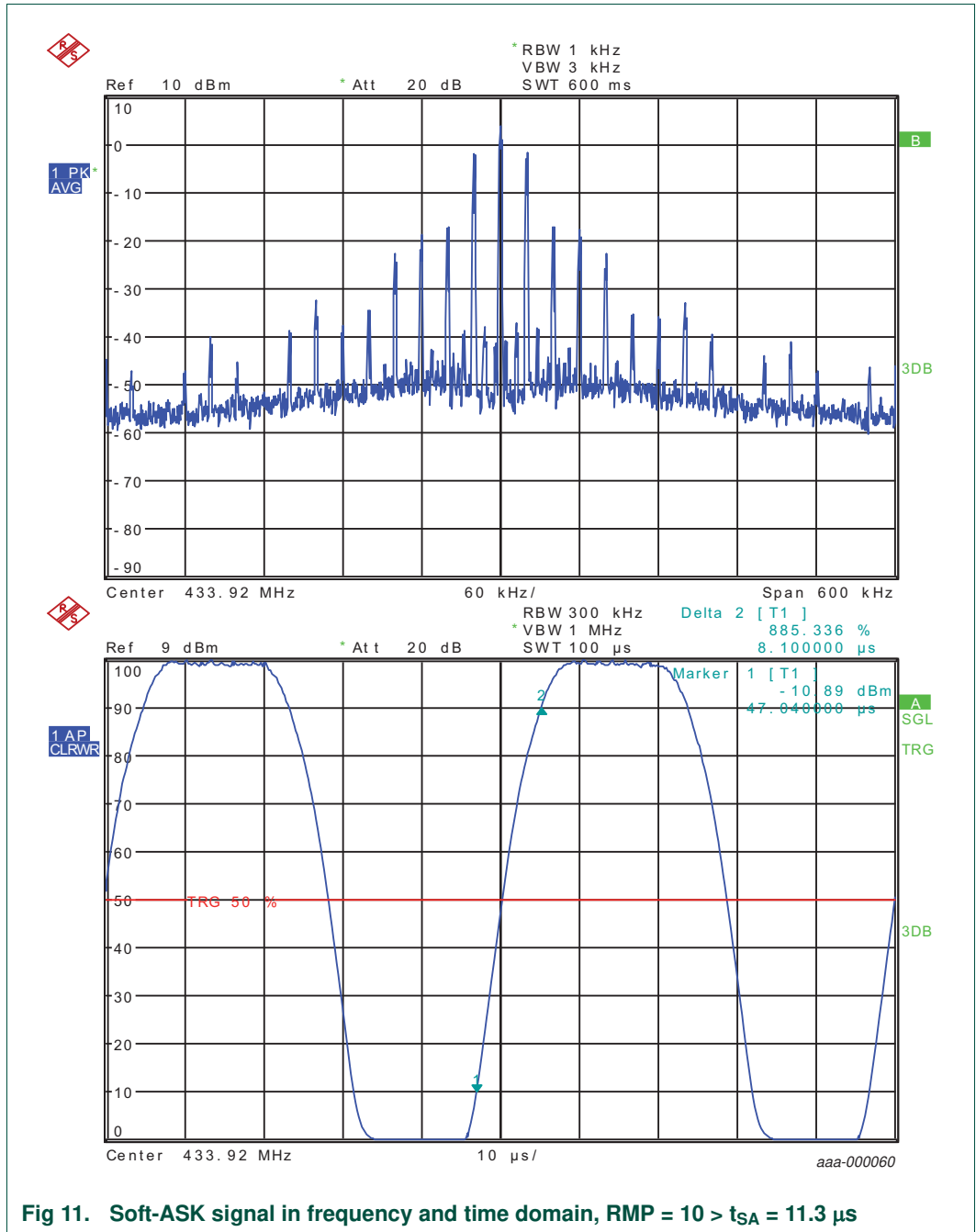

Fig 11. Soft-ASK signal in frequency and time domain, RMP = 10 > t_{SA} = 11.3 μs

5.5 FSK modulation

The output of OL2300, when set to FSK modulation, is measured in frequency and time domain for FSK and Soft-FSK. Figure 12 and Figure 13 show the results.

OL2300 was set to a modulation frequency of 20 kHz using an FSK deviation of 20.3 kHz. $V_{CC} = 2.7\text{ V}$, $AMH = 15$, $AML = 0$, $RBW = 200\text{ kHz}$.

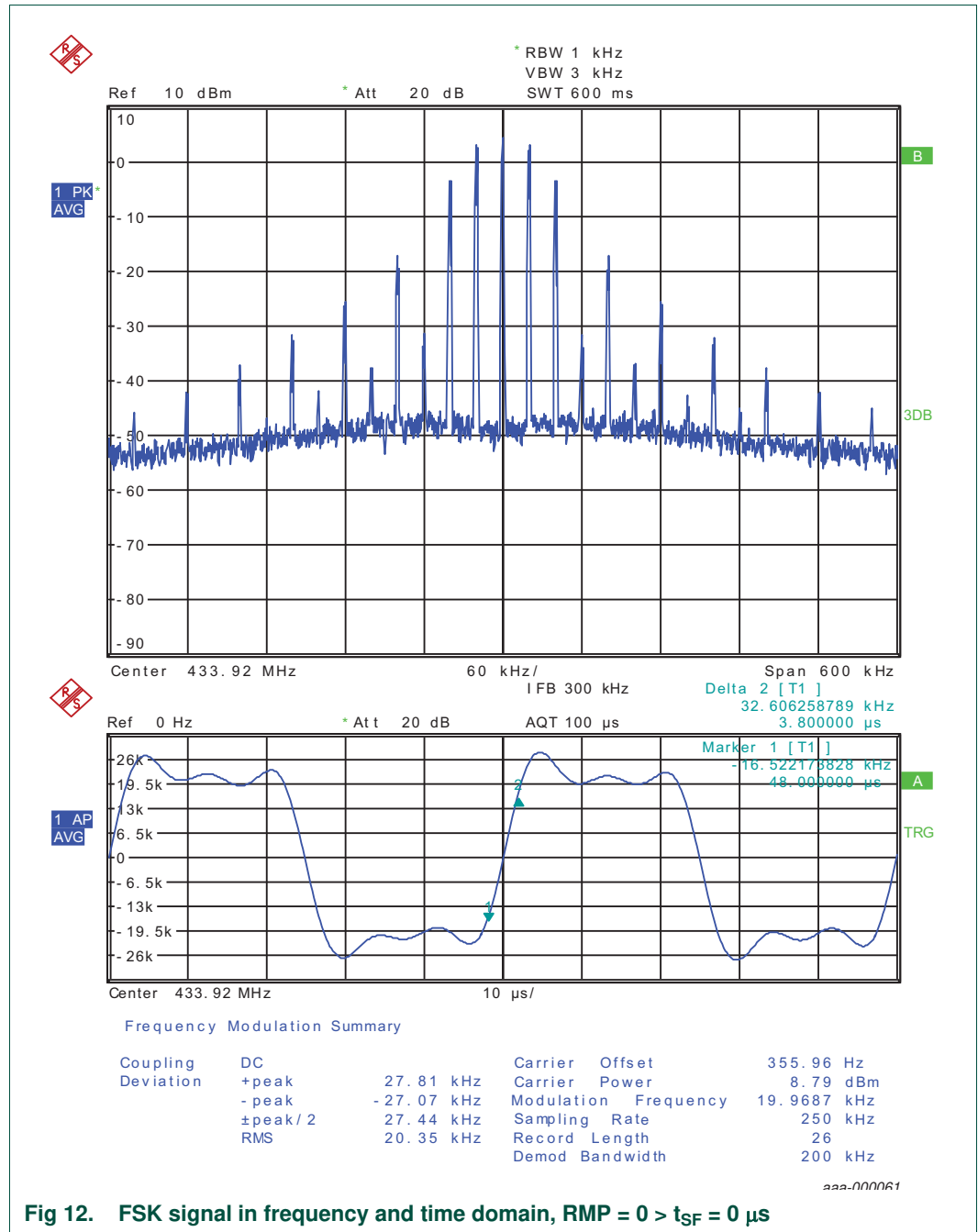

Fig 12. FSK signal in frequency and time domain, $RMP = 0 > t_{SF} = 0\text{ }\mu\text{s}$

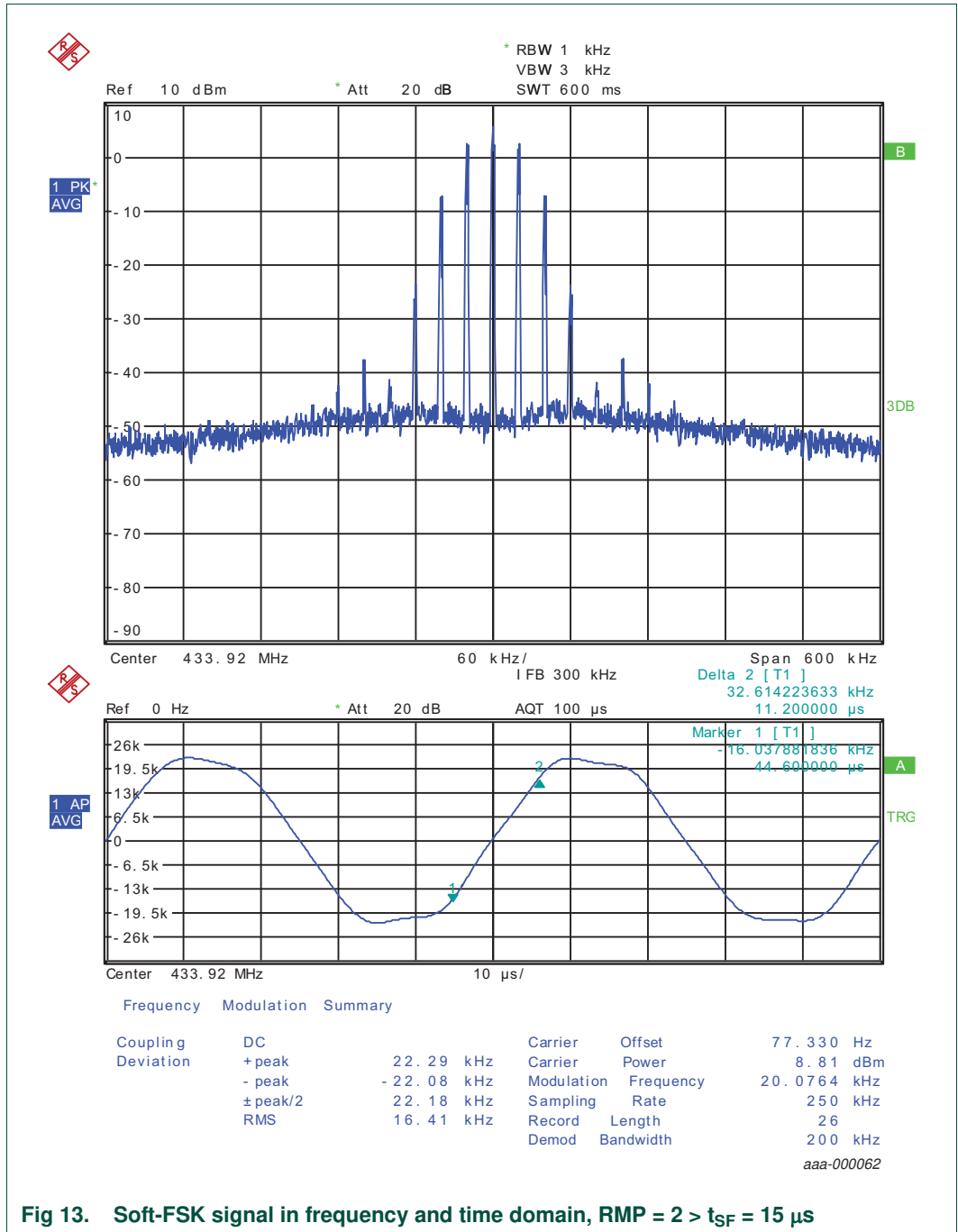

Fig 13. Soft-FSK signal in frequency and time domain, $RMP = 2 > t_{SF} = 15 \mu s$

6. Legal information

6.1 Definitions

Draft — The document is a draft version only. The content is still under internal review and subject to formal approval, which may result in modifications or additions. NXP Semiconductors does not give any representations or warranties as to the accuracy or completeness of information included herein and shall have no liability for the consequences of use of such information.

6.2 Disclaimers

Limited warranty and liability — Information in this document is believed to be accurate and reliable. However, NXP Semiconductors does not give any representations or warranties, expressed or implied, as to the accuracy or completeness of such information and shall have no liability for the consequences of use of such information.

In no event shall NXP Semiconductors be liable for any indirect, incidental, punitive, special or consequential damages (including - without limitation - lost profits, lost savings, business interruption, costs related to the removal or replacement of any products or rework charges) whether or not such damages are based on tort (including negligence), warranty, breach of contract or any other legal theory.

Notwithstanding any damages that customer might incur for any reason whatsoever, NXP Semiconductors' aggregate and cumulative liability towards customer for the products described herein shall be limited in accordance with the *Terms and conditions of commercial sale* of NXP Semiconductors.

Right to make changes — NXP Semiconductors reserves the right to make changes to information published in this document, including without limitation specifications and product descriptions, at any time and without notice. This document supersedes and replaces all information supplied prior to the publication hereof.

Suitability for use — NXP Semiconductors products are not designed, authorized or warranted to be suitable for use in life support, life-critical or safety-critical systems or equipment, nor in applications where failure or malfunction of an NXP Semiconductors product can reasonably be expected to result in personal injury, death or severe property or environmental damage. NXP Semiconductors accepts no liability for inclusion and/or use of NXP Semiconductors products in such equipment or applications and therefore such inclusion and/or use is at the customer's own risk.

Applications — Applications that are described herein for any of these products are for illustrative purposes only. NXP Semiconductors makes no representation or warranty that such applications will be suitable for the specified use without further testing or modification.

Customers are responsible for the design and operation of their applications and products using NXP Semiconductors products, and NXP Semiconductors accepts no liability for any assistance with applications or customer product

design. It is customer's sole responsibility to determine whether the NXP Semiconductors product is suitable and fit for the customer's applications and products planned, as well as for the planned application and use of customer's third party customer(s). Customers should provide appropriate design and operating safeguards to minimize the risks associated with their applications and products.

NXP Semiconductors does not accept any liability related to any default, damage, costs or problem which is based on any weakness or default in the customer's applications or products, or the application or use by customer's third party customer(s). Customer is responsible for doing all necessary testing for the customer's applications and products using NXP Semiconductors products in order to avoid a default of the applications and the products or of the application or use by customer's third party customer(s). NXP does not accept any liability in this respect.

Export control — This document as well as the item(s) described herein may be subject to export control regulations. Export might require a prior authorization from national authorities.

Evaluation products — This product is provided on an "as is" and "with all faults" basis for evaluation purposes only. NXP Semiconductors, its affiliates and their suppliers expressly disclaim all warranties, whether express, implied or statutory, including but not limited to the implied warranties of non-infringement, merchantability and fitness for a particular purpose. The entire risk as to the quality, or arising out of the use or performance, of this product remains with customer.

In no event shall NXP Semiconductors, its affiliates or their suppliers be liable to customer for any special, indirect, consequential, punitive or incidental damages (including without limitation damages for loss of business, business interruption, loss of use, loss of data or information, and the like) arising out of the use of or inability to use the product, whether or not based on tort (including negligence), strict liability, breach of contract, breach of warranty or any other theory, even if advised of the possibility of such damages.

Notwithstanding any damages that customer might incur for any reason whatsoever (including without limitation, all damages referenced above and all direct or general damages), the entire liability of NXP Semiconductors, its affiliates and their suppliers and customer's exclusive remedy for all of the foregoing shall be limited to actual damages incurred by customer based on reasonable reliance up to the greater of the amount actually paid by customer for the product or five dollars (US\$5.00). The foregoing limitations, exclusions and disclaimers shall apply to the maximum extent permitted by applicable law, even if any remedy fails of its essential purpose.

6.3 Trademarks

Notice: All referenced brands, product names, service names and trademarks are the property of their respective owners.

7. Contents

1	Introduction	3
2	Evaluation board schematic	4
3	Component placement	6
4	Usage	7
5	Measurement results	8
5.1	General	8
5.2	Output power (P_o)	9
5.2.1	$P_o = f(\text{AMH, PAM})$	9
5.2.2	$P_o = f(V_{CC}, \text{CASC, ENRAD})$	10
5.3	Output Spectrum	11
5.3.1	315 MHz	11
5.3.2	434 MHz	12
5.4	ASK modulation	14
5.5	FSK modulation	16
6	Legal information	18
6.1	Definitions	18
6.2	Disclaimers	18
6.3	Trademarks	18
7	Contents	19

Please be aware that important notices concerning this document and the product(s) described herein, have been included in section 'Legal information'.

© NXP B.V. 2011.

All rights reserved.

For more information, please visit: <http://www.nxp.com>

For sales office addresses, please send an email to: salesaddresses@nxp.com

Date of release: 29 August 2011

Document identifier: UM10473