



Chipsmall Limited consists of a professional team with an average of over 10 year of expertise in the distribution of electronic components. Based in Hongkong, we have already established firm and mutual-benefit business relationships with customers from,Europe,America and south Asia,supplying obsolete and hard-to-find components to meet their specific needs.

With the principle of “Quality Parts,Customers Priority,Honest Operation,and Considerate Service”,our business mainly focus on the distribution of electronic components. Line cards we deal with include Microchip,ALPS,ROHM,Xilinx,Pulse,ON,Everlight and Freescale. Main products comprise IC,Modules,Potentiometer,IC Socket,Relay,Connector.Our parts cover such applications as commercial,industrial, and automotives areas.

We are looking forward to setting up business relationship with you and hope to provide you with the best service and solution. Let us make a better world for our industry!



## Contact us

Tel: +86-755-8981 8866 Fax: +86-755-8427 6832

Email & Skype: info@chipsmall.com Web: www.chipsmall.com

Address: A1208, Overseas Decoration Building, #122 Zhenhua RD., Futian, Shenzhen, China



DATA SHEET

# PD18-73/PD18-73LF: 1.71-1.99 GHz Two-Way 0° Power Splitter/Combiner

## Applications

- Signal distribution/combining
- GSM, WCDMA, PCS/DCS

## Features

- Low cost
- Low profile
- Small SOT-6 package (MSL1, 260 °C per JEDEC J-STD-020)



Skyworks Pb-free products are compliant with all applicable legislation. For additional information, refer to *Skyworks Definition of Lead (Pb)-Free*, document number SQ04-0073.

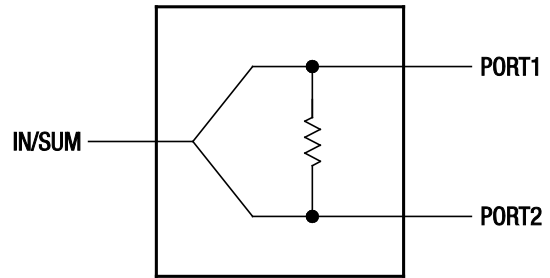

S2709

Figure 1. PD18-73/PD18-73LF Block Diagram

## Description

The PD18-73/PD18-73LF are monolithic, two-way in-phase hybrid junction power splitter/combiners for the 1.71 to 1.99 GHz band. Either device offers low loss, high isolation, good input/output matching, and exceptional phase/amplitude balance.

A functional block diagram is shown in Figure 1. The pin configuration and package are shown in Figure 2. Signal pin assignments and functional pin descriptions are provided in Table 1.

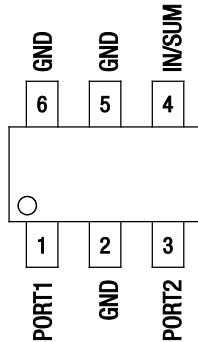

S2710

Figure 2. PD18-73/PD18-73LF Pinout – 6-Pin SOT-6 (Top View)

**Table 1. PD18-73/PD18-73LF Signal Descriptions**

Pin #	Name	Description	Pin #	Name	Description
1	PORT1	RF port 1	4	IN/SUM	RF in or sum port
2	GND	RF ground	5	GND	RF ground
3	PORT2	RF port 2	6	GND	RF ground

**Table 2. PD18-73/PD18-73LF Absolute Maximum Ratings (Note 1)**

Parameter	Symbol	Minimum	Maximum	Units
RF input power, CW (Note 2)	P <sub>IN</sub>		1.5	W
RF input power, CW (Note 3)	P <sub>IN</sub>		0.75	W
Operating temperature	T <sub>OP</sub>	-40	+85	°C
Storage temperature	T <sub>STG</sub>	-65	+150	°C

**Note 1:** Exposure to maximum rating conditions for extended periods may reduce device reliability. There is no damage to device with only one parameter set at the limit and all other parameters set at or below their nominal value. Exceeding any of the limits listed here may result in permanent damage to the device.

**Note 2:** When used as a power divider with a 2.0:1 maximum VSWR on all ports.

**Note 3:** When used as a power combiner with a 2.0:1 maximum VSWR on all ports.

---

**CAUTION:** Although this device is designed to be as robust as possible, Electrostatic Discharge (ESD) can damage this device. This device must be protected at all times from ESD. Static charges may easily produce potentials of several kilovolts on the human body or equipment, which can discharge without detection. Industry-standard ESD precautions should be used at all times.

---

**Table 3. PD18-73/PD18-73LF Electrical Specifications (Note 1)**  
**(Characteristic Impedance [Z<sub>0</sub>] = 50 Ω, Unless Otherwise Noted)**

Parameter	Symbol	Test Condition	Min	Typical	Max	Units
Frequency	f		1.71		1.99	GHz
Insertion loss less 3 dB split	IL	P <sub>IN</sub> @ pin 4 = 0 dBm		0.4	0.6	dB
Isolation	Iso	P <sub>IN</sub> @ pin 4 = 0 dBm	18	23		dB
Input VSWR	VSWR <sub>IN</sub>	P <sub>IN</sub> @ pin 4 = 0 dBm		1.3:1	1.5:1	-
Output VSWR	VSWR <sub>OUT</sub>	P <sub>IN</sub> @ pin 4 = 0 dBm		1.2:1	1.4:1	-
Amplitude balance		P <sub>IN</sub> @ pin 4 = 0 dBm		±0.1	±0.2	dB
Phase balance		P <sub>IN</sub> @ pin 4 = 0 dBm		±1	±3	deg

**Note 1:** Performance is guaranteed only under the conditions listed in this Table.

### Electrical and Mechanical Specifications

The absolute maximum ratings of the PD18-73/PD18-73LF are provided in Table 2. Electrical specifications are provided in Table 3.

Typical performance characteristics of the PD18-73/PD18-73LF are illustrated in Figures 3 through 8.

**Typical Performance Characteristics**  
 (Characteristic Impedance [ $Z_0$ ] = 50  $\Omega$ , Unless Otherwise Noted)

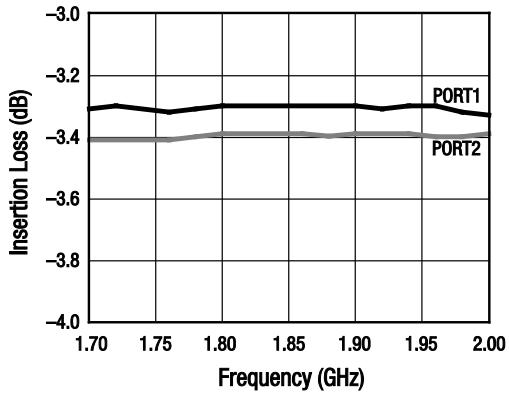

**Figure 3. Insertion Loss vs Frequency**

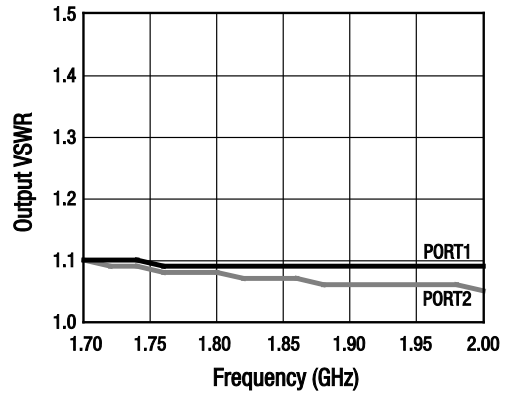

**Figure 4. Output VSWR vs Frequency**

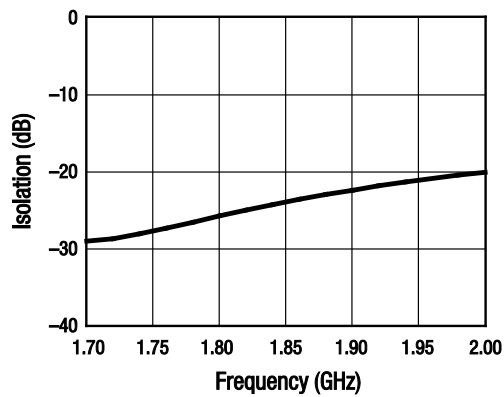

**Figure 5. Isolation vs Frequency**

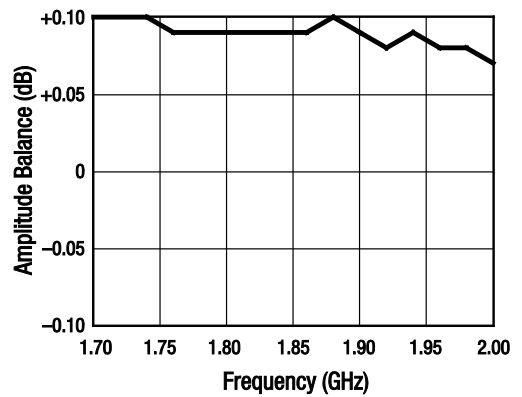

**Figure 6. Amplitude Balance vs Frequency**

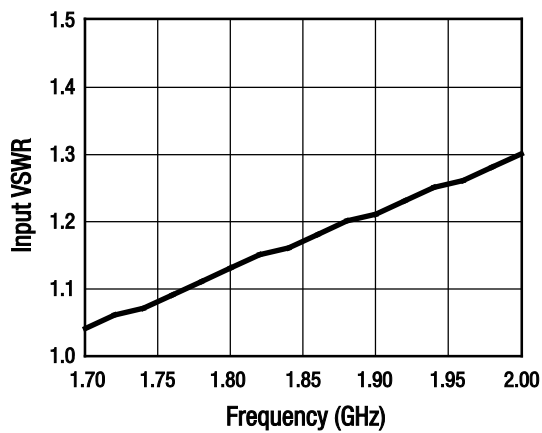

**Figure 7. Input VSWR vs Frequency**

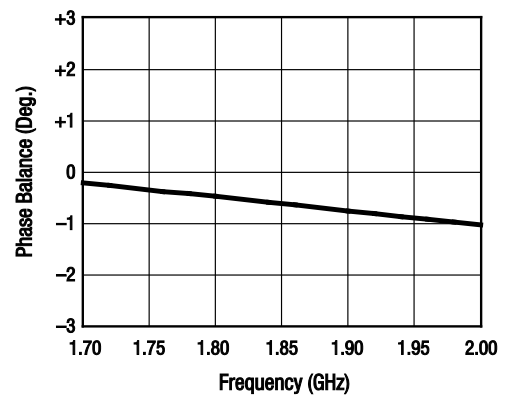

**Figure 8. Phase Balance vs Frequency**

**Recommended Board Layout**

The recommended layout for the PD18-73/PD18-73LF is shown in Figure 9.

**Package Dimensions**

Package dimensions for the 6-pin SOT-6 are shown in Figure 10, and tape and reel dimensions are provided in Figure 11.

**Package and Handling Information**

Instructions on the shipping container label regarding exposure to moisture after the container seal is broken must be followed. Otherwise, problems related to moisture absorption may occur when the part is subjected to high temperature during solder assembly.

THE PD18-73/PD18-73LF is rated to Moisture Sensitivity Level 1 (MSL1) at 260 °C. It can be used for lead or lead-free soldering. For additional information, refer to the Skyworks Application Note, *Solder Reflow Information*, document number 200164.

Care must be taken when attaching this product, whether it is done manually or in a production solder reflow environment. Production quantities of this product are shipped in a standard tape and reel format.

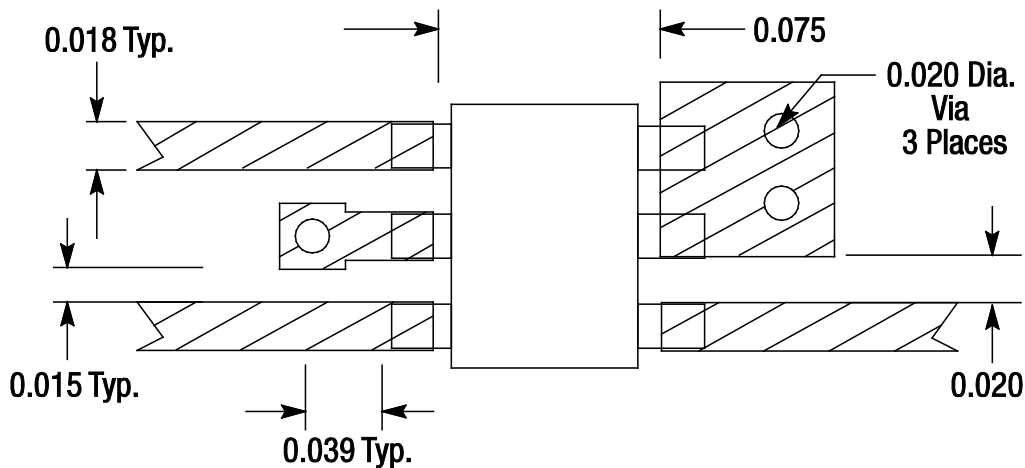

Material is 10 mil FR4.  
All measurements in inches.

S2711

**Figure 9. PD18-73/PD18-73LF Recommended Board Layout**

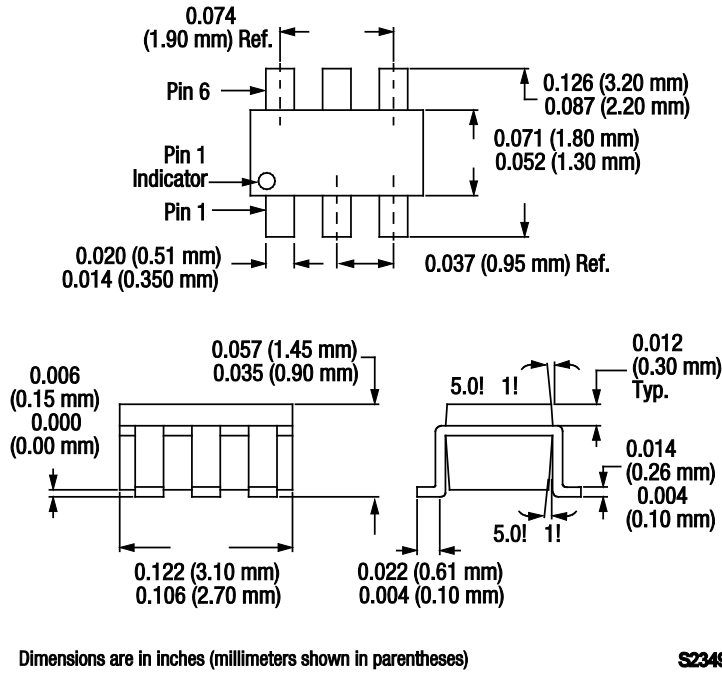
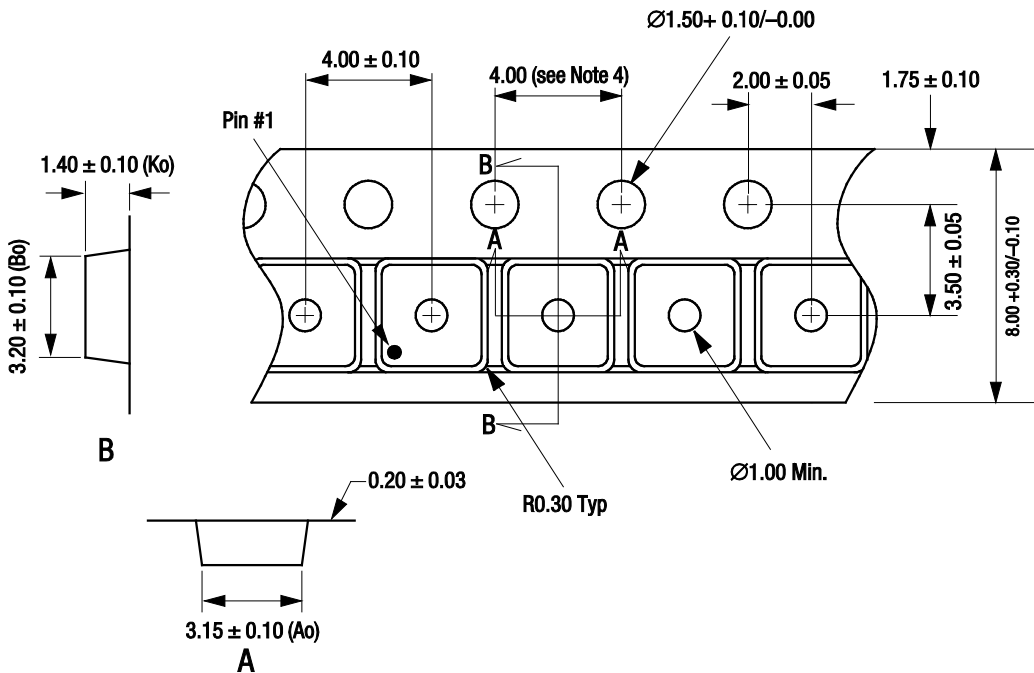

Figure 10. PD18-73/PD18-73LF 6-Pin SOT-6 Package Dimensions



- Notes:
1. Carrier tape: black conductive polystyrene.
  2. Cover tape material: transparent conductive HSA.
  3. Cover tape size: 5.40 mm width.
  4. Ten sprocket hole pitch cumulative tolerance =  $\pm 0.20$  mm.
  5. All measurements are in millimeters.
  6. Standard reel size is 7 inches. Standard reel quantity is 3000 pcs.

S1681

Figure 11. PD18-73/PD18-73LF Tape and Reel Dimensions

## Ordering Information

Model Name	Manufacturing Part Number
PD18-73/PD18-73LF Two-Way Power Splitter/Combiner	PD18-73/PD18-73LF

Copyright © 2002-2008, 2011 Skyworks Solutions, Inc. All Rights Reserved.

Information in this document is provided in connection with Skyworks Solutions, Inc. ("Skyworks") products or services. These materials, including the information contained herein, are provided by Skyworks as a service to its customers and may be used for informational purposes only by the customer. Skyworks assumes no responsibility for errors or omissions in these materials or the information contained herein. Skyworks may change its documentation, products, services, specifications or product descriptions at any time, without notice. Skyworks makes no commitment to update the materials or information and shall have no responsibility whatsoever for conflicts, incompatibilities, or other difficulties arising from any future changes.

No license, whether express, implied, by estoppel or otherwise, is granted to any intellectual property rights by this document. Skyworks assumes no liability for any materials, products or information provided hereunder, including the sale, distribution, reproduction or use of Skyworks products, information or materials, except as may be provided in Skyworks Terms and Conditions of Sale.

THE MATERIALS, PRODUCTS AND INFORMATION ARE PROVIDED "AS IS" WITHOUT WARRANTY OF ANY KIND, WHETHER EXPRESS, IMPLIED, STATUTORY, OR OTHERWISE, INCLUDING FITNESS FOR A PARTICULAR PURPOSE OR USE, MERCHANTABILITY, PERFORMANCE, QUALITY OR NON-INFRINGEMENT OF ANY INTELLECTUAL PROPERTY RIGHT; ALL SUCH WARRANTIES ARE HEREBY EXPRESSLY DISCLAIMED. SKYWORKS DOES NOT WARRANT THE ACCURACY OR COMPLETENESS OF THE INFORMATION, TEXT, GRAPHICS OR OTHER ITEMS CONTAINED WITHIN THESE MATERIALS. SKYWORKS SHALL NOT BE LIABLE FOR ANY DAMAGES, INCLUDING BUT NOT LIMITED TO ANY SPECIAL, INDIRECT, INCIDENTAL, STATUTORY, OR CONSEQUENTIAL DAMAGES, INCLUDING WITHOUT LIMITATION, LOST REVENUES OR LOST PROFITS THAT MAY RESULT FROM THE USE OF THE MATERIALS OR INFORMATION, WHETHER OR NOT THE RECIPIENT OF MATERIALS HAS BEEN ADVISED OF THE POSSIBILITY OF SUCH DAMAGE.

Skyworks products are not intended for use in medical, lifesaving or life-sustaining applications, or other equipment in which the failure of the Skyworks products could lead to personal injury, death, physical or environmental damage. Skyworks customers using or selling Skyworks products for use in such applications do so at their own risk and agree to fully indemnify Skyworks for any damages resulting from such improper use or sale.

Customers are responsible for their products and applications using Skyworks products, which may deviate from published specifications as a result of design defects, errors, or operation of products outside of published parameters or design specifications. Customers should include design and operating safeguards to minimize these and other risks. Skyworks assumes no liability for applications assistance, customer product design, or damage to any equipment resulting from the use of Skyworks products outside of stated published specifications or parameters.

Skyworks, the Skyworks symbol, and "Breakthrough Simplicity" are trademarks or registered trademarks of Skyworks Solutions, Inc., in the United States and other countries. Third-party brands and names are for identification purposes only, and are the property of their respective owners. Additional information, including relevant terms and conditions, posted at [www.skyworksinc.com](http://www.skyworksinc.com), are incorporated by reference.