



Chipsmall Limited consists of a professional team with an average of over 10 year of expertise in the distribution of electronic components. Based in Hongkong, we have already established firm and mutual-benefit business relationships with customers from,Europe,America and south Asia,supplying obsolete and hard-to-find components to meet their specific needs.

With the principle of “Quality Parts,Customers Priority,Honest Operation,and Considerate Service”,our business mainly focus on the distribution of electronic components. Line cards we deal with include Microchip,ALPS,ROHM,Xilinx,Pulse,ON,Everlight and Freescale. Main products comprise IC,Modules,Potentiometer,IC Socket,Relay,Connector.Our parts cover such applications as commercial,industrial, and automotives areas.

We are looking forward to setting up business relationship with you and hope to provide you with the best service and solution. Let us make a better world for our industry!



## Contact us

Tel: +86-755-8981 8866 Fax: +86-755-8427 6832

Email & Skype: info@chipsmall.com Web: www.chipsmall.com

Address: A1208, Overseas Decoration Building, #122 Zhenhua RD., Futian, Shenzhen, China



# Photoelectrics

## Retro-reflective for Transparent Objects

### Type PD30CNG02...MU

CARLO GAVAZZI



- Miniature sensor range
- Range: 2 m, with reflector
- Sensitivity adjustment by Teach-In programming
- Modulated, red light 617 nm
- Supply voltage: 10 to 30 VDC
- Output: 100 mA, NPN or PNP preset
- Make and break switching function programmable
- LED indication for output, stability and power ON
- Protection: reverse polarity, short circuit and transients
- Cable and plug versions
- Excellent EMC performance
- Mute function (sensor blanking)



## Product Description

The PD30CNG02 sensor family comes in a compact 10 x 30 x 20 mm reinforced PMMA/ABS housing. The sensors are useful in applications where detection of transparent objects are needed. Compact housing and high power LED for excellent performance-size ratio.

The Teach-In function for adjustment of the sensitivity makes the sensors highly flexible. The output type is preset (NPN or PNP), and the output switching function is programmable (NO or NC). The mute function can be used for testing the sensor for: Malfunctioning, disconnection, optical axis adjustment, dusty and dirty lenses.

## Ordering Key PD30CNG02PPM5MU

Type	PD30CNG02PPM5MU
Housing style	PD30CNG02PPM5MU
Housing size	PD30CNG02PPM5MU
Housing material	PD30CNG02PPM5MU
Housing length	PD30CNG02PPM5MU
Detection principle	PD30CNG02PPM5MU
Sensing distance	PD30CNG02PPM5MU
Output type	PD30CNG02PPM5MU
Output configuration	PD30CNG02PPM5MU
Connection type	PD30CNG02PPM5MU
Mute	PD30CNG02PPM5MU

## Type Selection

Housing W x H x D	Range S <sub>n</sub>	Connection	Ordering no. NPN Make or break switching	Ordering no. PNP Make or break switching
10 x 30 x 20 mm	2 m	Cable	PD 30 CNG 02 NPMU	PD 30 CNG 02 PPMU
10 x 30 x 20 mm	2 m	Plug	PD 30 CNG 02 NPM5MU	PD 30 CNG 02 PPM5MU

**Note:** Reflectors to be ordered separately

## Specifications EN 60947-5-2

<b>Rated operating distance (S<sub>n</sub>)</b>	Up to 2 m, with reflector Ø 80 mm (ER4)	<b>Protection</b>	Short-circuit, reverse polarity and transients
<b>Detection reliability</b>	20% attenuation	<b>Light source</b>	inGaAlP, LED, 617 nm
<b>Blind zone</b>	10 mm	<b>Light type, not polarized</b>	Red, modulated
<b>Sensitivity</b>	Adjustable by Teach-In	<b>Sensing angle</b>	± 2°
<b>Temperature drift</b>	≤ 0.1%/°C Teach settings are valid for teach temperature ± 20°C	<b>Ambient light</b>	10,000 lux
<b>Hysteresis (H) (differential travel)</b>	≤ 10%	<b>Light spot</b>	110 mm @ 1.5 m
<b>Rated operational volt. (U<sub>B</sub>)</b>	10 to 30 VDC (ripple included)	<b>Operating frequency</b>	1000 Hz
<b>Ripple (U<sub>rpp</sub>)</b>	≤ 10%	<b>Response time</b>	OFF-ON (t <sub>ON</sub> ) ≤ 0.5 ms ON-OFF (t <sub>OFF</sub> ) ≤ 0.5 ms
<b>Output current</b>	≤ 100 mA ≤ 100 mA (max. load capacity 100 nF)	<b>Power ON delay (t<sub>v</sub>)</b>	≤ 300 ms
<b>No load supply current (I<sub>o</sub>)</b>	≤ 30 mA @ 24 VDC	<b>Output function</b>	NPN and PNP NO/NC switching function
<b>Minimum operational current (I<sub>m</sub>)</b>	0.5 mA	<b>Mute function</b>	Preset Set up by button
<b>OFF-state current (I<sub>r</sub>)</b>	≤ 100 µA	Emitter off	0 to 3 sec
<b>Voltage drop (U<sub>d</sub>)</b>	≤ 2.4 VDC @ 100 mA	Operating mode	0 to 2.5 VDC (NPN) 5 to 30 VDC (PNP) Not connected
		<b>Indication</b>	LED, yellow LED, green
		Output ON	LED, yellow
		Signal stability ON and power ON	LED, green



## Specifications (cont.) EN 60947-5-2

<b>Environment</b>		<b>Rated insulation voltage</b>	500 VAC (rms)
Installation category	III (IEC 60664/60664A; 60947-1)	<b>Housing material</b>	
Pollution degree	3 (IEC 60664/60664A; 60947-1)	Body	ABS
Degree of protection	IP 67 (IEC 60529; 60947-1)	Front material	PMMA, red
<b>Ambient temperature</b>		<b>Connection</b>	
Operating	-25° to +55°C (-13° to +131°F)	Cable	PVC, black, 2 m 4 x 0.14 mm <sup>2</sup> , Ø = 3.3 mm M8, 4-pin (CON, 54-series)
Storage	-40° to +70°C (-40° to +158°F)	Plug	
<b>Vibration</b>	10 to 55 Hz, 0.5 mm/7.5 g (IEC 60068-2-6)	<b>Weight</b>	With cable: 40 g With plug: 10 g
<b>Shock</b>	30 g / 11ms, 3 pos, 3 neg per axis (IEC 60068-2-6, 60068-2-32)	<b>CE-marking</b>	Yes
		<b>Approvals</b>	cULus (UL508)

## Operation Diagram

tv = Power ON delay

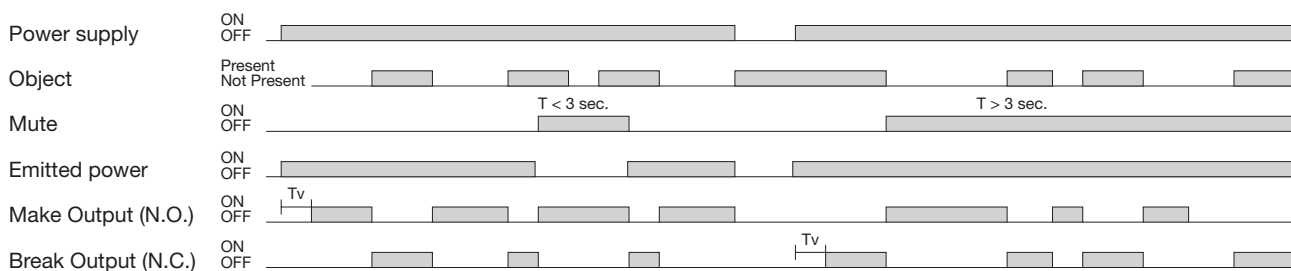

## Wiring Diagrams

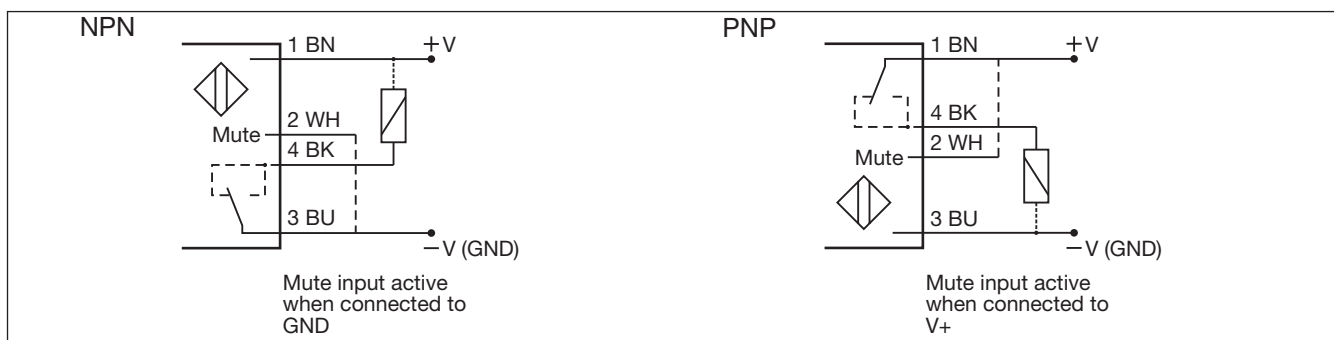

## Detection Diagram

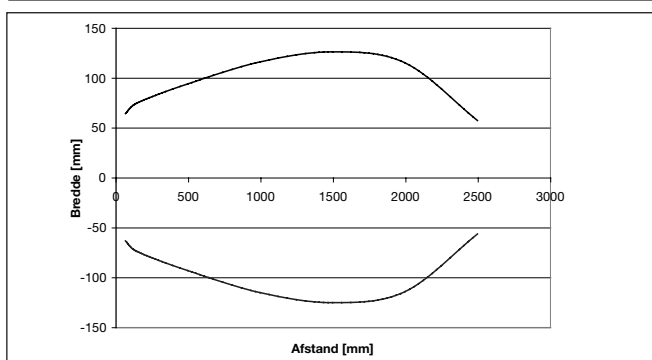

## Excess Gain



## Signal Stability Indication

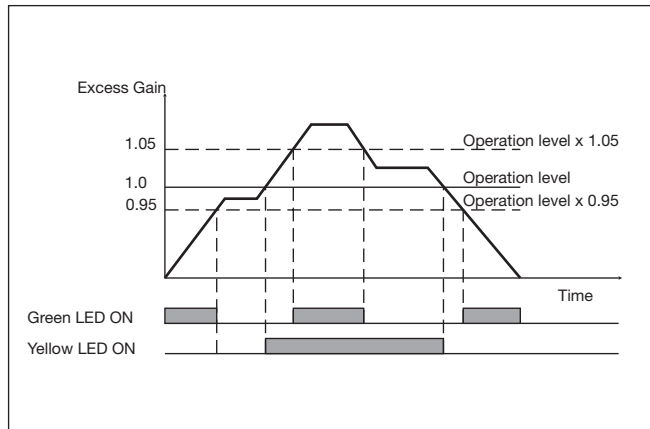

## Accessories

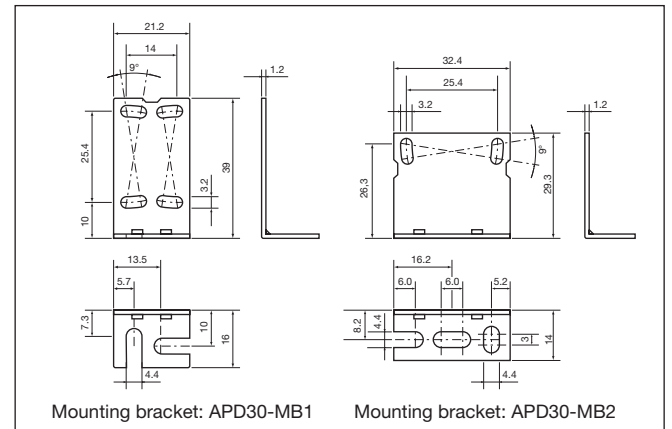

## Dimensions

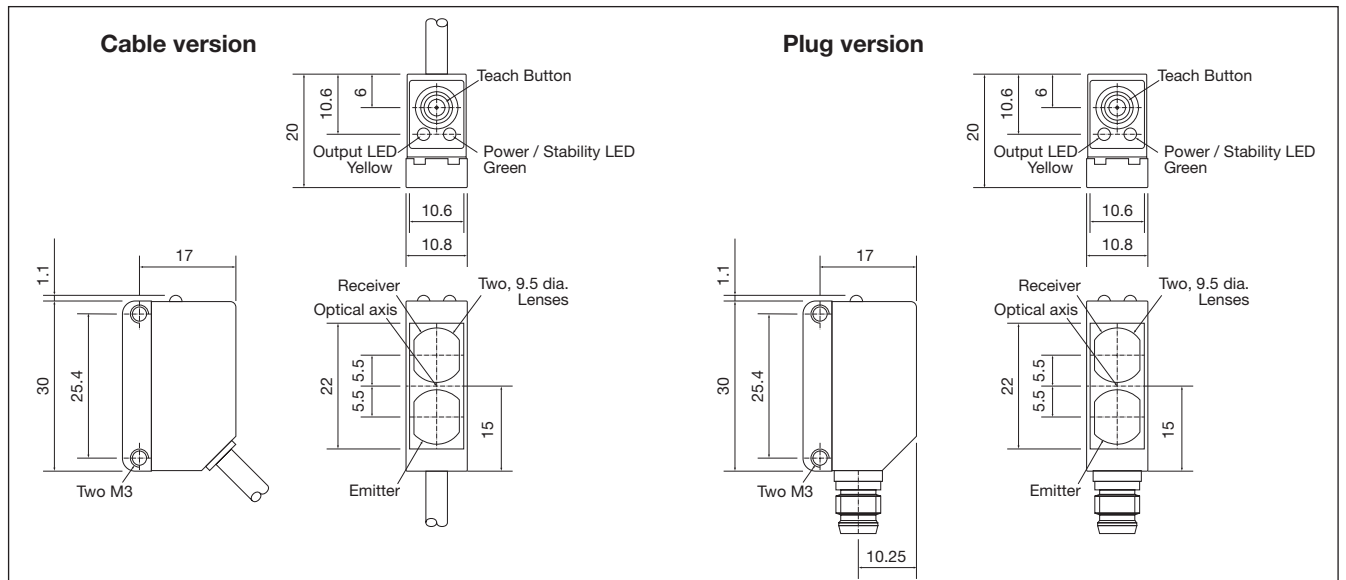

## Installation Hints

<p>To avoid interference from inductive voltage / current peaks, separate the proximity switch cables from any other power cables. E.g. Engine, contactor or solenoid cables</p> <p>Incorrect Correct &gt; 100 mm</p>	<p>Relief of the cable strain</p> <p>Incorrect Correct</p> <p>The cable should not be pulled</p>	<p>Protection of the sensing face</p> <p>Incorrect</p> <p>A proximity switch should not serve as mechanical stop</p>	<p>Sensor mounted on a mobile carrier</p> <p>Any repetitive flexing of the cable should be avoided</p>
---	--	--	--

## Delivery Contents

- Photoelectric switch: PD 30 CNG 02 ...MU
- Installation instruction
- Mountingbracket APD30-MB1
- **Packaging:** Cardboard box

## Accessories

- Mounting bracket APD30-MB2 to be purchased separately

## Teach functions

### Normal operation, optimized switching point

1. Line up the sensor with the reflector. Yellow LED and Green LED are ON.
2. Press the button for 3 seconds until both LEDs flashes simultaneously.  
(The first switch point is stored)
3. Place the object between the sensor and reflector in the detection zone.
4. Press the button once and the sensor is ready to operate (Green LED ON, Yellow LED ON)  
(The second switch point is stored)

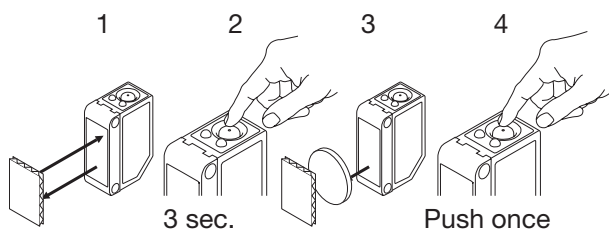

### For make or break set-up (N.O. or N.C.)

1. Press the button for 10 seconds, until the green LEDs flashes.
2. While the green LED flashes, the output is inverted each time the button is pressed. Yellow LED indicates N.O. function selected.  
If the button is not pressed within the next 10 seconds, the current output is stored.

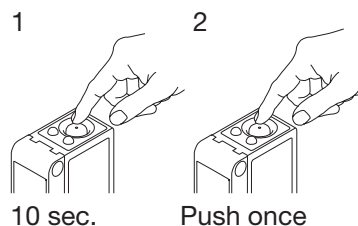

### For maximum sensing distance (default setting)

1. Line up the sensor with the reflector, place a new transparent object between the sensor and reflector in the detection zone. Yellow LED is OFF and Green LED is ON.
2. Press the button for 3 seconds until both LEDs flashes simultaneously.  
(The first switch point is stored)
3. Press the button a second time and the sensor is ready to operate (Green LED ON, Yellow LED ON)  
(The second switch point is stored)

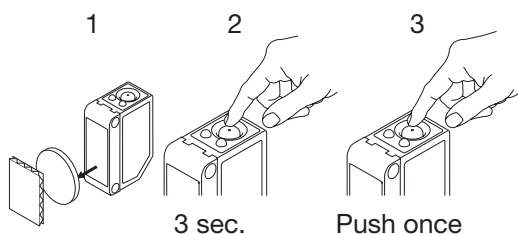

### For the most transparent objects

1. Line up the sensor with the reflector. Yellow LED and Green LED are ON.
2. Press the button for 3 seconds until both LEDs flashes simultaneously.  
(The first switch point is stored)
3. Press the button a second time and the sensor is ready to operate (Green LED ON, Yellow LED ON)  
(The second switch point is stored)

