



Chipsmall Limited consists of a professional team with an average of over 10 year of expertise in the distribution of electronic components. Based in Hongkong, we have already established firm and mutual-benefit business relationships with customers from,Europe,America and south Asia,supplying obsolete and hard-to-find components to meet their specific needs.

With the principle of “Quality Parts,Customers Priority,Honest Operation,and Considerate Service”,our business mainly focus on the distribution of electronic components. Line cards we deal with include Microchip,ALPS,ROHM,Xilinx,Pulse,ON,Everlight and Freescale. Main products comprise IC,Modules,Potentiometer,IC Socket,Relay,Connector.Our parts cover such applications as commercial,industrial, and automotives areas.

We are looking forward to setting up business relationship with you and hope to provide you with the best service and solution. Let us make a better world for our industry!



Contact us

Tel: +86-755-8981 8866 Fax: +86-755-8427 6832

Email & Skype: info@chipsmall.com Web: www.chipsmall.com

Address: A1208, Overseas Decoration Building, #122 Zhenhua RD., Futian, Shenzhen, China





PD54008 PD54008S

RF POWER TRANSISTORS *The LdmoST FAMILY*

N-CHANNEL ENHANCEMENT-MODE LATERAL MOSFETs

- EXCELLENT THERMAL STABILITY
- COMMON SOURCE CONFIGURATION
- $P_{OUT} = 8\text{ W}$ with 11.5 dB gain @ 500 MHz / 7.5 V
- NEW RF PLASTIC PACKAGE

DESCRIPTION

The PD54008 is a common source N-Channel, enhancement-mode lateral Field-Effect RF power transistor. It is designed for high gain, broad band commercial and industrial applications. It operates at 7 V in common source mode at frequencies of up to 1 GHz. PD54008 boasts the excellent gain, linearity and reliability of ST's latest LDMOS technology mounted in the first true SMD plastic RF power package, PowerSO-10RF. PD54008's superior linearity performance makes it an ideal solution for portable radio.

The PowerSO-10 plastic package, designed to offer high reliability, is the first ST JEDEC approved, high power SMD package. It has been specially optimized for RF needs and offers excellent RF performances and ease of assembly.

Mounting recommendations are available in www.st.com/rf/ (look for application note AN1294)

ABSOLUTE MAXIMUM RATINGS ($T_{CASE} = 25^{\circ}\text{C}$)

Symbol	Parameter	Value	Unit
$V_{(BR)DSS}$	Drain-Source Voltage	25	V
V_{GS}	Gate-Source Voltage	± 20	V
I_D	Drain Current	5	A
P_{DISS}	Power Dissipation (@ $T_c = 70^{\circ}\text{C}$)	73	W
T_j	Max. Operating Junction Temperature	165	$^{\circ}\text{C}$
T_{STG}	Storage Temperature	-65 to +150	$^{\circ}\text{C}$

THERMAL DATA

$R_{th(j-c)}$	Junction -Case Thermal Resistance	1.2	$^{\circ}\text{C}/\text{W}$
---------------	-----------------------------------	-----	-----------------------------

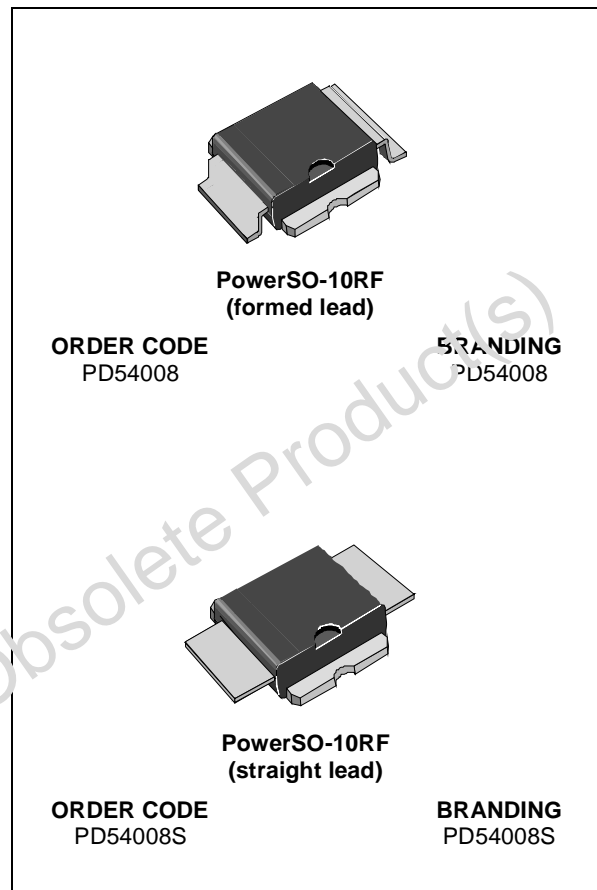

PD54008 - PD54008S

ELECTRICAL SPECIFICATION (T_{CASE} = 25°C)

STATIC

Symbol	Test Conditions		Min.	Typ.	Max.	Unit
I _{DSS}	V _{GS} = 0 V	V _{DS} = 25 V			1	μA
I _{GSS}	V _{GS} = 20 V	V _{DS} = 0 V			1	μA
V _{GS(Q)}	V _{DS} = 10 V	I _D = 150 mA	2.0		5.0	V
V _{DS(ON)}	V _{GS} = 10 V	I _D = 2 A			0.6	V
g _{FS}	V _{DS} = 10 V	I _D = 2 A	2.0	2.5		mho
C _{ISS}	V _{GS} = 0 V	V _{DS} = 7.5 V		91		pF
C _{OSS}	V _{GS} = 0 V	V _{DS} = 7.5 V		68		pF
C _{RSS}	V _{GS} = 0 V	V _{DS} = 7.5 V		8.5		pF

DYNAMIC

Symbol	Test Conditions				Min.	Typ.	Max.	Unit
P _{1dB}	V _{DD} = 7.5 V	I _{DQ} = 150 mA		f = 500 MHz	8			W
G _P	V _{DD} = 7.5 V	I _{DQ} = 150 mA	P _{OUT} = 8 W	f = 500 MHz	10	11.5		dB
η _D	V _{DD} = 7.5 V	I _{DQ} = 150 mA	P _{OUT} = 8 W	f = 500 MHz	50	55		%
Load mismatch	V _{DD} = 9.5 V	I _{DQ} = 150 mA	P _{OUT} = 8 W	f = 500 MHz	20:1			VSWR
	ALL PHASE ANGLES							

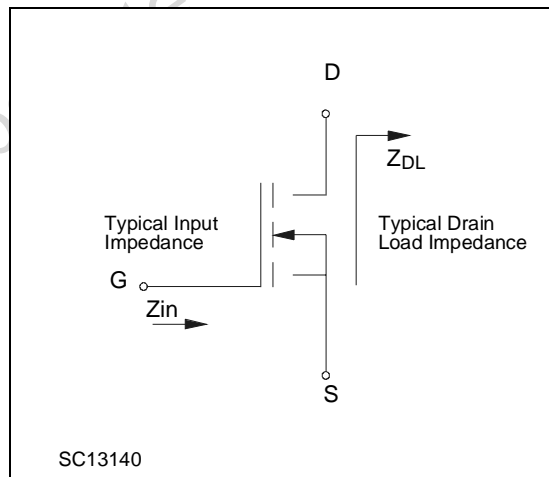
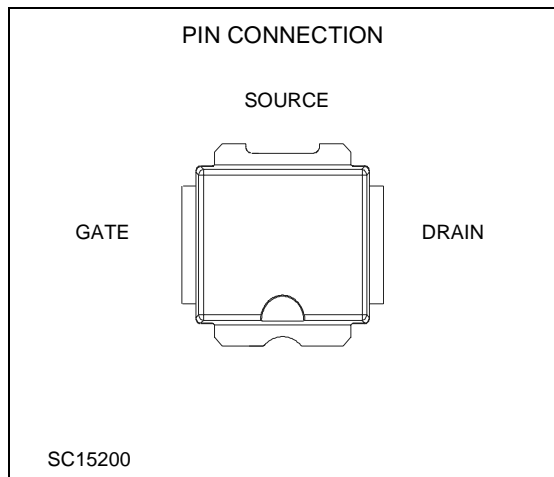

IMPEDANCE DATA

PD54008

FREQ. (MHz)	Z _{IN} (Ω)	Z _{DL} (Ω)
175	2.3 - j 4.8	1.9 + j 1.9
200	2.1 - j 4.0	2.8 + j 1.1
250	1.3 - j 3.8	2.3 + j 0.0
480	1.65 + j 0.53	1.35 - j 1.57
500	1.73 + j 0.96	1.48 - j 1.62
520	1.73 + j 1.15	1.47 - j 1.97

PD54008S

FREQ. (MHz)	Z _{IN} (Ω)	Z _{DL} (Ω)
480	1.22 - j 0.91	1.04 - j 0.65
500	1.20 - j 0.48	1.28 - j 0.55
520	1.28 - j 0.74	1.44 - j 0.99



TYPICAL PERFORMANCE

Capacitance vs. Drain Voltage

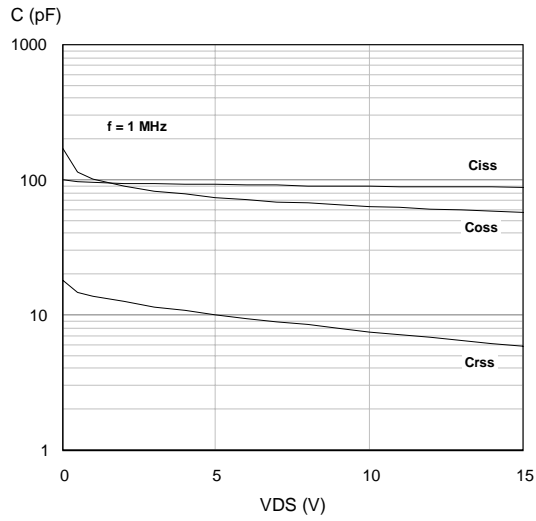

Drain Current vs. Gate-Source Voltage

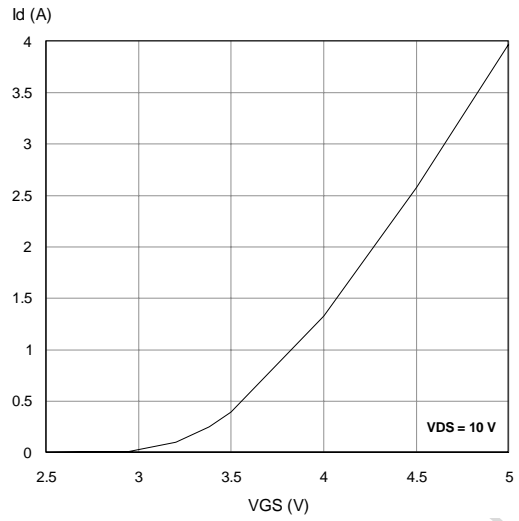

Gate-Source Voltage vs Case Temperature

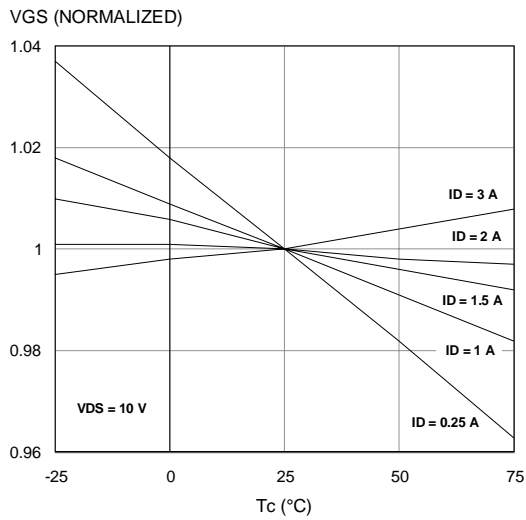

Obsolete Product(s)

PD54008 - PD54008S

TYPICAL PERFORMANCE (PD54008)

Output Power vs. Input Power

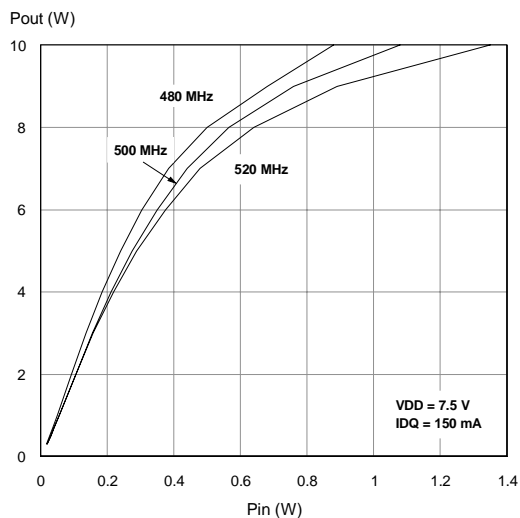

Power Gain vs. Output Power

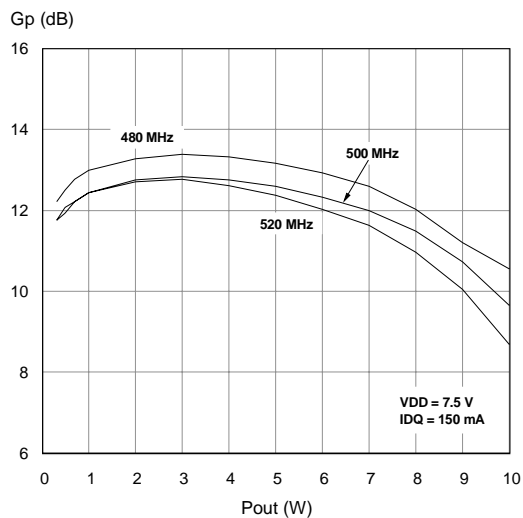

Drain Efficiency vs. Output Power

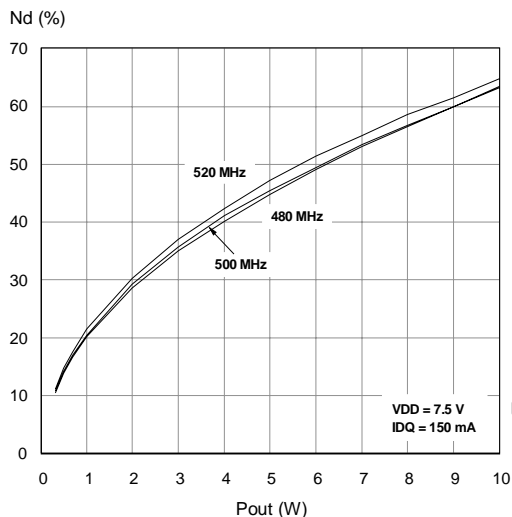

Return Loss vs. Output Power

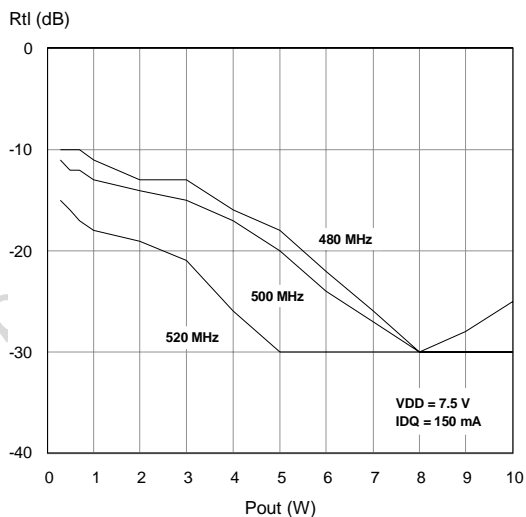

Output Power vs. Bias Current

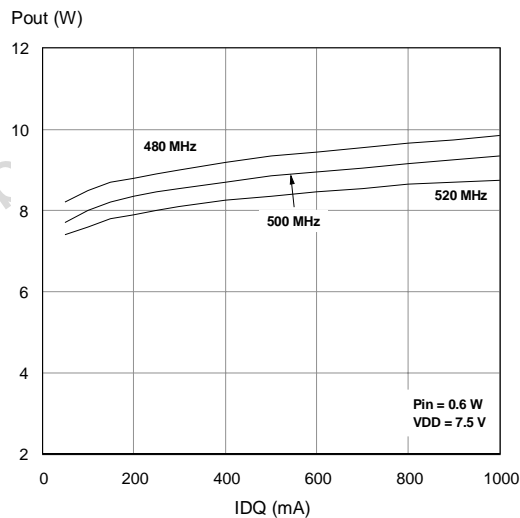

Drain Efficiency vs. Bias Current

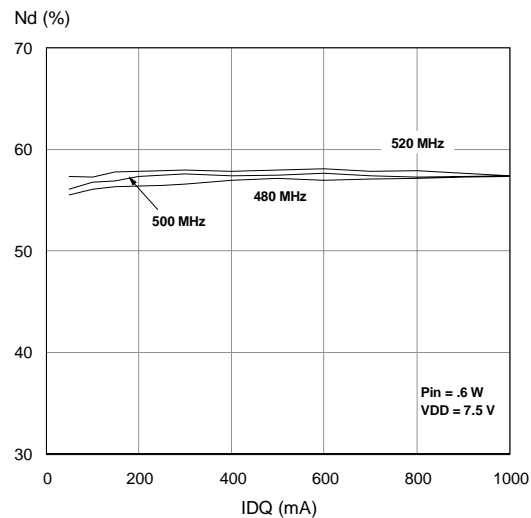

TYPICAL PERFORMANCE (PD54008)

Output Power vs. Drain Voltage

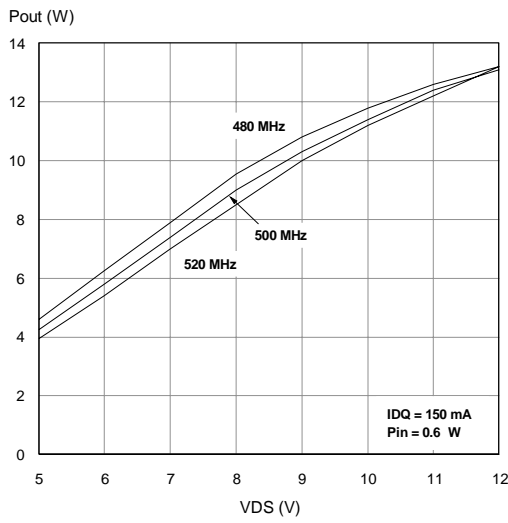

Drain Efficiency vs. Drain Voltage

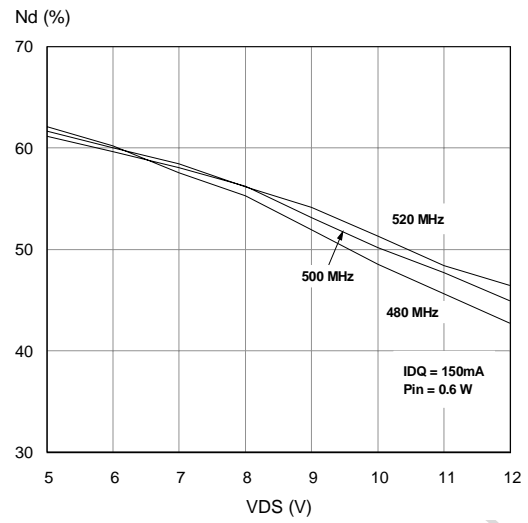

Output Power vs. Gate Bias Voltage

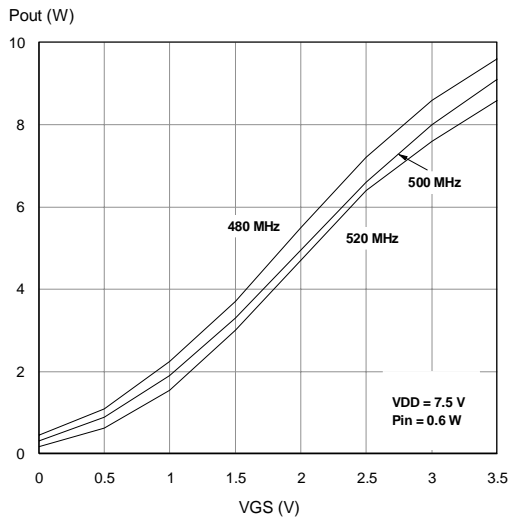

IMD3 vs. Output Power (470MHz)

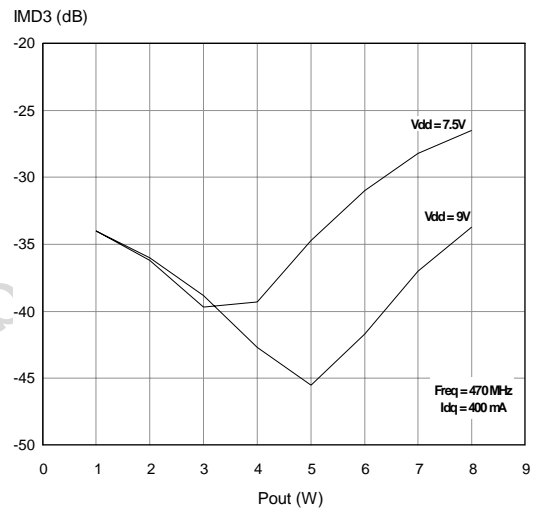

Power Gain vs. Output Power

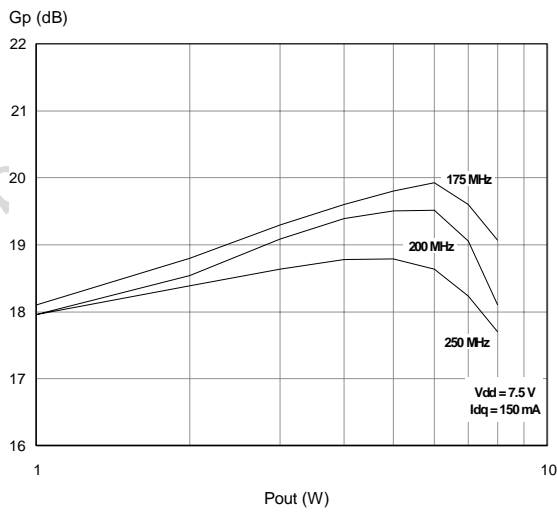

Return Loss and Efficiency vs. Output Power

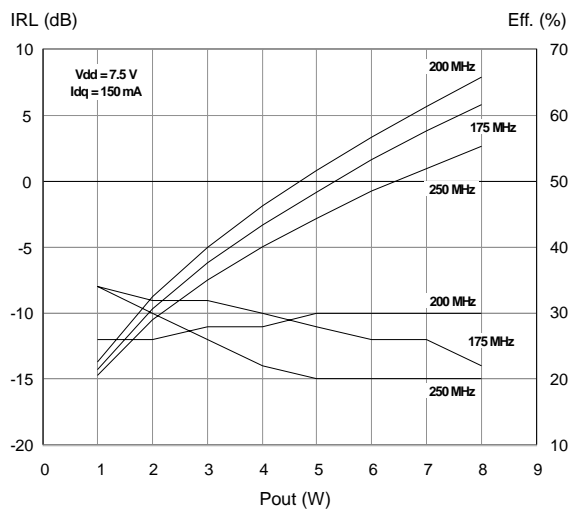

PD54008 - PD54008S

TYPICAL PERFORMANCE (PD54008S)

Output Power vs. Input Power

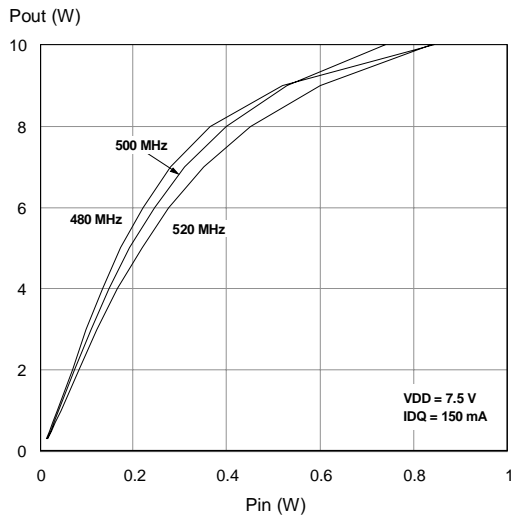

Power Gain vs. Output Power

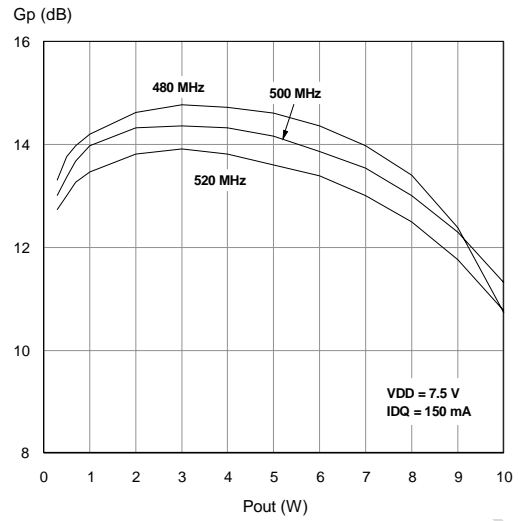

Drain Efficiency vs. Output Power

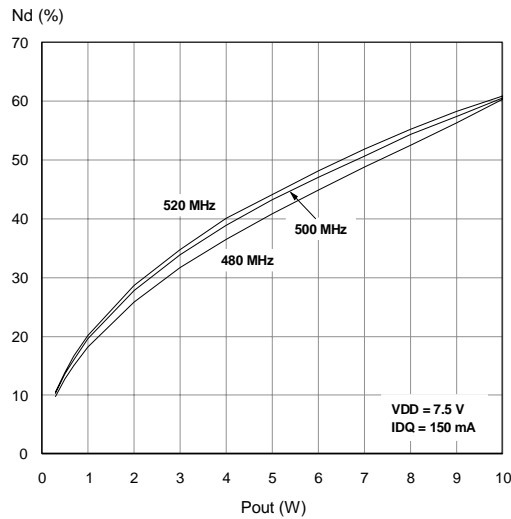

Return Loss vs. Output Power

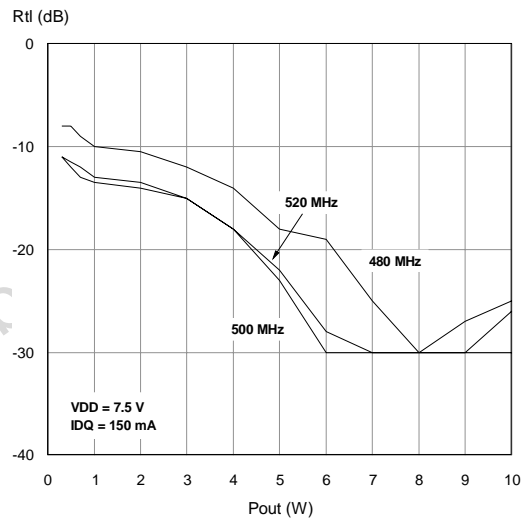

Output Power vs. Bias Current

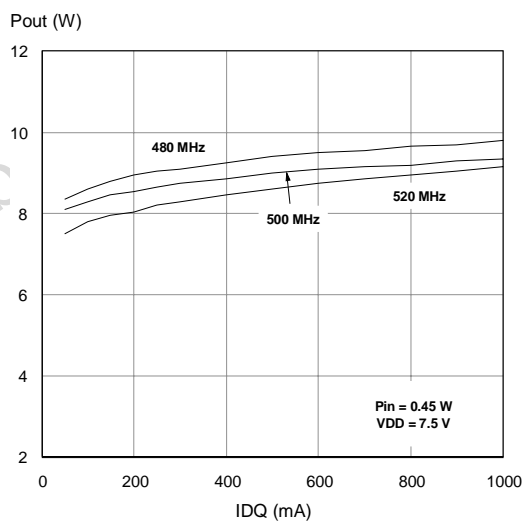

Drain Efficiency vs. Bias Current

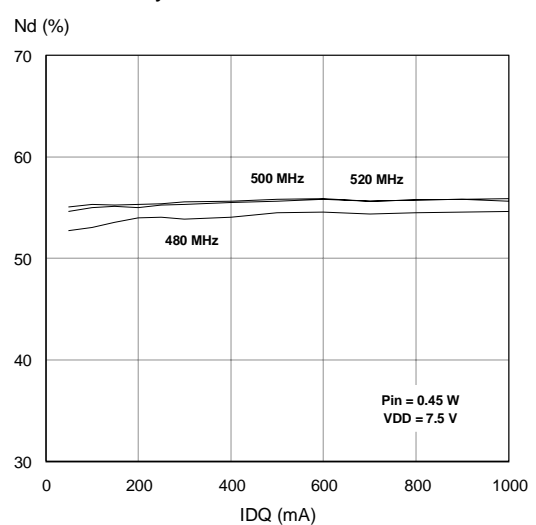

TYPICAL PERFORMANCE (PD54008S)

Output Power vs. Drain Voltage

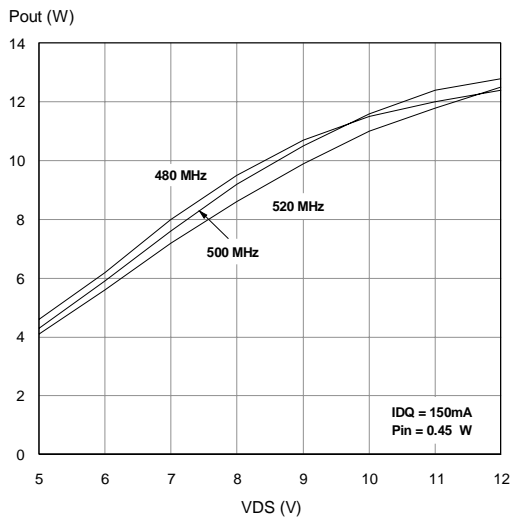

Drain Efficiency vs. Drain Voltage

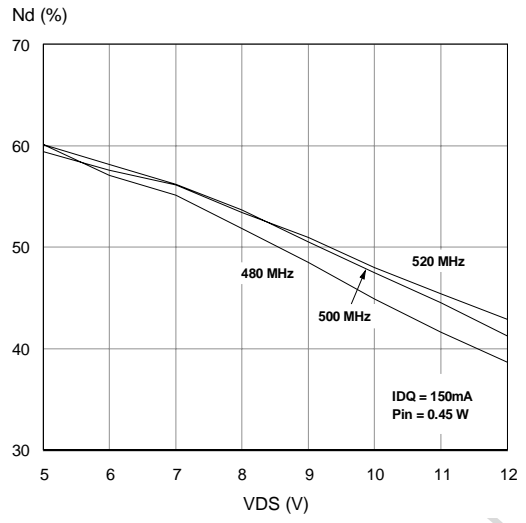

Output Power vs. Gate Bias Voltage

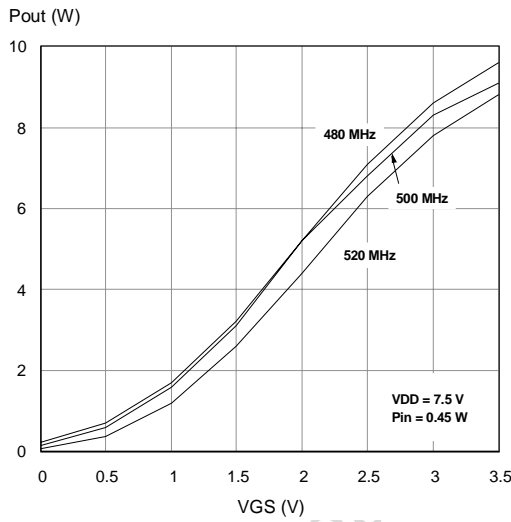

Obsolete Product(s)

TEST CIRCUIT SCHEMATIC

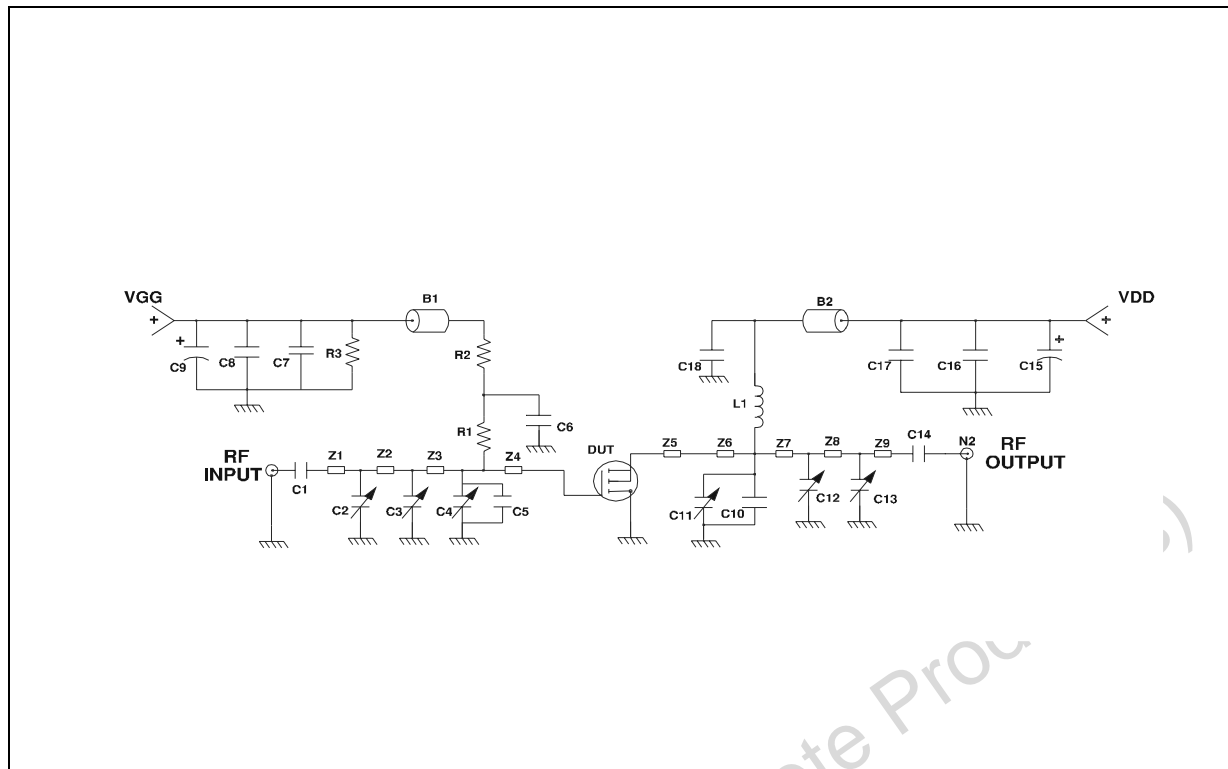

TEST CIRCUIT COMPONENT PART LIST

COMPONENT	DESCRIPTION
B1,B2	FERRITE BEAD
C1,C12	300 pF, 100 mil CHIP CAPACITOR
C2,C3,C4,C11,C12,C13	1 to 20 pF TRIMMER CAPACITOR
C6, C18	120 pF 100 mil CHIP CAPACITOR
C9, C15	10 μ F, 50 V ELECTROLYTIC CAPACITOR
C8, C16	0.1 mF, 100 mil CHIP CAP
C7, C17	1.000 pF 100 mil CHIP CAP
C5, C10	33 pF, 100 mil CHIP CAP
L1	56 nH, 7 TURN, COILCRAFT
N1, N2	TYPE N FLANGE MOUNT
R1	15 Ω , 1 W CHIP RESISTOR
R2	1 K Ω , 1 W CHIP RESISTOR
R3	33 K Ω , 1 W CHIP RESISTOR
Z1	0.471" X 0.080" MICROSTRIP
Z2	1.082" X 0.080" MICROSTRIP
Z3	0.372" X 0.080" MICROSTRIP
Z4,Z5	0.260" X 0.223" MICROSTRIP
Z6	0.050" X 0.080" MICROSTRIP
Z7	0.551" X 0.080" MICROSTRIP
Z8	0.825" X 0.080" MICROSTRIP
Z9	0.489" X 0.080" MICROSTRIP
BOARD	ROGER, ULTRA LAM 2000 THK 0.030", $\epsilon_r = 2.55$ 2oz. ED cu 2 SIDES.

TEST CIRCUIT

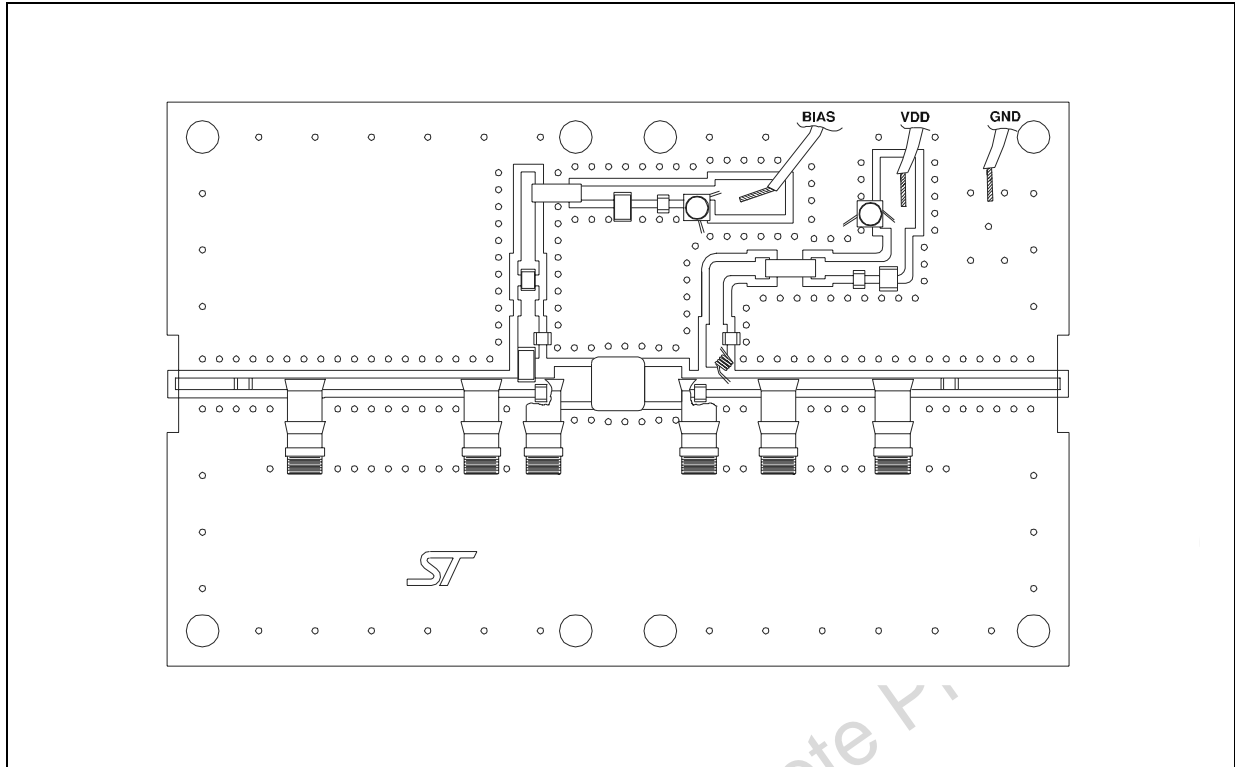

TEST CIRCUIT PHOTOMASTER

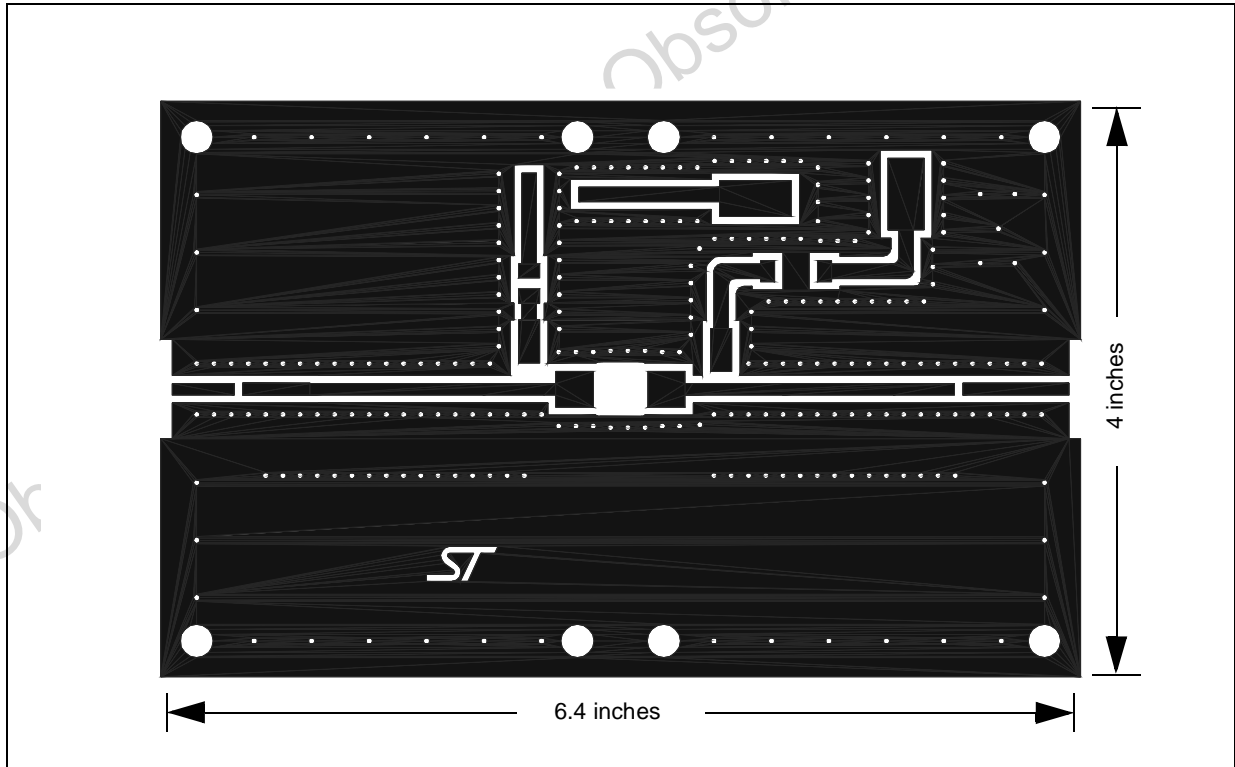

PD54008 - PD54008S**COMMON SOURCE S-PARAMETER (PD54008S)** $(V_{DS} = 7.5V \quad I_{DS} = 150mA)$

FREQ (MHz)	$ S_{11} $	$S_{11}\angle\Phi$	$ S_{21} $	$S_{21}\angle\Phi$	$ S_{12} $	$S_{12}\angle\Phi$	$ S_{22} $	$S_{22}\angle\Phi$
50	0.760	-161	9.32	84	0.034	-3	0.743	-160
100	0.810	-167	4.44	72	0.003	-16	0.761	-166
150	0.838	-169	2.86	63	0.031	-24	0.783	-167
200	0.862	-171	2.01	56	0.028	-31	0.817	-168
250	0.881	-172	1.50	48	0.026	-38	0.845	-169
300	0.900	-173	1.16	42	0.023	-43	0.866	-170
350	0.916	-174	0.92	37	0.021	-47	0.888	-171
400	0.927	0	0.75	32	0.019	-51	0.906	-172
450	0.938	-175	0.61	28	0.017	-54	0.918	-173
500	0.945	-176	0.52	25	0.015	-56	0.932	-174
550	0.952	-177	0.44	22	0.013	-59	0.940	-175
600	0.957	-178	0.38	19	0.012	-60	0.950	-176
650	0.963	-178	0.33	16	0.011	-61	0.951	-176
700	0.965	-179	0.29	14	0.009	-60	0.958	-177
750	0.968	-180	0.25	12	0.008	-63	0.960	-178
800	0.973	180	0.23	10	0.007	-65	0.962	-178
850	0.973	179	0.20	9	0.006	-65	0.961	-179
900	0.974	179	0.18	7	0.005	-55	0.971	-180
950	0.976	178	0.17	5	0.005	-58	0.970	180
1000	0.979	178	0.15	4	0.003	-58	0.967	179
1050	0.981	177	0.14	3	0.002	-50	0.970	179
1100	0.978	177	0.13	2	0.002	-36	0.974	178
1150	0.979	177	0.12	1	0.001	-16	0.975	179
1200	0.980	176	0.11	0	0.001	36	0.973	179
1250	0.981	176	0.10	-1	0.001	49	0.990	178
1300	0.981	175	0.10	-3	0.002	60	0.994	176
1350	0.981	175	0.09	-3	0.002	92	0.976	176
1400	0.980	175	0.08	-4	0.002	98	0.977	176
1450	0.977	174	0.08	-4	0.004	110	0.975	175
1500	0.977	174	0.07	-4	0.005	118	0.978	175

Obsolete Product

COMMON SOURCE S-PARAMETER (PD54008S)

($V_{DS} = 7.5V$ $I_{DS} = 800mA$)

FREQ (MHz)	$ S_{11} $	$S_{11}\angle\Phi$	$ S_{21} $	$S_{21}\angle\Phi$	$ S_{12} $	$S_{12}\angle\Phi$	$ S_{22} $	$S_{22}\angle\Phi$
50	0.825	-171	10.81	84	0.017	-2	0.844	-172
100	0.871	-174	5.27	79	0.017	-8	0.846	-175
150	0.890	-176	3.54	74	0.017	-11	0.849	-176
200	0.901	-177	2.61	70	0.016	-15	0.857	-176
250	0.905	-177	2.04	64	0.016	-18	0.862	-176
300	0.910	-178	1.66	60	0.015	-22	0.871	-177
350	0.916	-178	1.38	55	0.014	-24	0.879	-177
400	0.922	-178	1.17	51	0.013	-27	0.891	-177
450	0.927	-179	1.00	47	0.012	-30	0.899	-177
500	0.935	-179	0.86	43	0.011	-32	0.908	-177
550	0.938	-180	0.75	40	0.010	-32	0.914	-178
600	0.944	-180	0.66	37	0.009	-35	0.925	-178
650	0.949	180	0.59	34	0.008	-33	0.926	-179
700	0.951	179	0.53	31	0.007	-33	0.932	-179
750	0.953	179	0.47	29	0.007	-32	0.937	-180
800	0.958	178	0.43	26	0.006	-28	0.944	-180
850	0.960	178	0.39	24	0.006	-25	0.940	180
900	0.961	178	0.36	22	0.005	-26	0.951	179
950	0.964	177	0.33	20	0.004	-19	0.950	179
1000	0.966	177	0.30	18	0.004	-17	0.947	178
1050	0.968	176	0.28	16	0.004	-7	0.954	178
1100	0.967	176	0.26	15	0.003	7	0.958	178
1150	0.968	176	0.24	13	0.003	14	0.958	178
1200	0.970	176	0.23	12	0.003	37	0.957	178
1250	0.971	175	0.22	10	0.003	45	0.974	177
1300	0.970	175	0.20	8	0.003	48	0.979	176
1350	0.973	174	0.19	7	0.003	59	0.963	176
1400	0.972	174	0.17	5	0.004	75	0.966	175
1450	0.970	174	0.16	4	0.004	88	0.961	175
1500	0.970	174	0.15	3	0.005	102	0.967	174

Obsolete

PD54008 - PD54008S

COMMON SOURCE S-PARAMETER (PD54008S)

($V_{DS} = 7.5V$ $I_{DS} = 1.5A$)

FREQ (MHz)	S ₁₁	S ₁₁ ∠Φ	S ₂₁	S ₂₁ ∠Φ	S ₁₂	S ₁₂ ∠Φ	S ₂₂	S ₂₂ ∠Φ
50	0.843	-173	10.89	84	0.001	-2	0.864	-174
100	0.888	-175	5.32	80	0.014	-6	0.863	-176
150	0.905	-177	3.60	76	0.014	-8	0.866	-177
200	0.915	-178	2.66	72	0.013	-11	0.870	-177
250	0.916	-178	2.11	68	0.013	-13	0.875	-178
300	0.920	-179	1.73	63	0.013	-16	0.881	-178
350	0.924	-179	1.44	59	0.012	-18	0.889	-178
400	0.927	-179	1.23	55	0.011	-18	0.893	-178
450	0.934	-180	1.00	51	0.010	-23	0.901	-178
500	0.937	-180	0.93	48	0.010	-22	0.907	-178
550	0.939	180	0.82	44	0.009	-23	0.916	-179
600	0.944	180	0.72	42	0.008	-26	0.923	-179
650	0.948	179	0.65	38	0.008	-24	0.921	-179
700	0.949	179	0.58	36	0.007	-23	0.932	-180
750	0.952	178	0.53	33	0.007	-22	0.934	180
800	0.957	178	0.48	31	0.006	-20	0.937	180
850	0.958	178	0.44	29	0.005	-13	0.936	179
900	0.959	177	0.40	27	0.005	-12	0.946	178
950	0.961	177	0.37	25	0.004	-5	0.945	179
1000	0.963	177	0.35	23	0.005	-2	0.946	178
1050	0.965	176	0.32	21	0.004	7	0.947	178
1100	0.964	176	0.30	19	0.003	15	0.954	177
1150	0.967	176	0.28	17	0.004	28	0.952	178
1200	0.967	175	0.27	15	0.004	39	0.953	178
1250	0.969	175	0.25	13	0.004	46	0.970	177
1300	0.970	175	0.23	11	0.004	50	0.973	176
1350	0.971	174	0.22	10	0.004	56	0.957	176
1400	0.970	174	0.20	8	0.004	69	0.961	175
1450	0.968	174	0.19	7	0.005	81	0.958	175
1500	0.970	173	0.17	6	0.006	95	0.962	174

Obsolete

COMMON SOURCE S-PARAMETER (PD54008)

(V_{DS} = 7.5V I_{DS} = 150mA)

FREQ (MHz)	S ₁₁	S ₁₁ ∠Φ	S ₂₁	S ₂₁ ∠Φ	S ₁₂	S ₁₂ ∠Φ	S ₂₂	S ₂₂ ∠Φ
50	0.771	-164	7.80	86	0.036	-4	0.773	-164
100	0.819	-170	3.81	75	0.034	-14	0.786	-170
150	0.850	-172	2.47	65	0.033	-21	0.800	-171
200	0.865	-174	1.76	57	0.030	-28	0.826	-172
250	0.881	-175	1.32	50	0.028	-35	0.847	-172
300	0.896	-176	1.03	43	0.025	-39	0.867	-173
350	0.909	-176	0.82	38	0.023	-43	0.886	-174
400	0.921	-177	0.67	33	0.021	-46	0.897	-175
450	0.930	-178	0.56	29	0.018	-51	0.912	-176
500	0.939	-179	0.47	24	0.016	-52	0.924	-177
550	0.944	179	0.40	21	0.014	-53	0.930	-178
600	0.952	179	0.35	18	0.013	-56	0.938	-179
650	0.956	178	0.30	15	0.011	-55	0.943	180
700	0.960	177	0.27	13	0.009	-54	0.949	179
750	0.961	176	0.24	10	0.008	-54	0.952	179
800	0.963	175	0.21	8	0.007	-51	0.955	178
850	0.966	174	0.19	6	0.006	-49	0.960	177
900	0.967	174	0.17	4	0.004	-34	0.964	176
950	0.968	173	0.16	3	0.004	-34	0.964	175
1000	0.969	172	0.14	1	0.003	-28	0.962	175
1050	0.972	171	0.13	0	0.003	-6	0.969	174
1100	0.970	171	0.12	-1	0.002	7	0.967	173
1150	0.969	170	0.11	-2	0.003	25	0.963	173
1200	0.971	169	0.10	-3	0.003	49	0.966	172
1250	0.970	169	0.10	-4	0.005	58	0.969	172
1300	0.970	168	0.09	-5	0.005	61	0.969	171
1350	0.970	167	0.09	-6	0.006	68	0.966	170
1400	0.969	167	0.08	-6	0.006	70	0.965	169
1450	0.967	166	0.07	-7	0.007	79	0.965	169
1500	0.963	166	0.07	-8	0.008	92	0.964	168

Obsolete Product

PD54008 - PD54008S

COMMON SOURCE S-PARAMETER (PD54008)

(V_{DS} = 7.5V I_{DS} = 800mA)

FREQ (MHz)	S ₁₁	∠S ₁₁ Φ	S ₂₁	∠S ₂₁ Φ	S ₁₂	∠S ₁₂ Φ	S ₂₂	∠S ₂₂ Φ
50	0.837	-173	8.92	84	0.017	-2	0.867	-174
100	0.882	-176	4.35	79	0.017	-7	0.870	-177
150	0.902	-178	3.00	75	0.017	-8	0.868	-178
200	0.909	-179	2.17	71	0.016	-12	0.876	-178
250	0.912	-180	1.71	66	0.016	-14	0.878	-179
300	0.918	180	1.40	61	0.015	-16	0.884	-179
350	0.920	179	1.17	57	0.014	-18	0.890	-180
400	0.925	179	1.00	52	0.013	-19	0.893	-180
450	0.928	178	0.86	48	0.013	-21	0.902	180
500	0.932	177	0.75	44	0.012	-22	0.911	179
550	0.935	177	0.66	41	0.011	-20	0.914	179
600	0.939	176	0.59	38	0.01	-22	0.920	178
650	0.944	175	0.53	34	0.009	-17	0.924	178
700	0.947	175	0.47	32	0.008	-13	0.927	177
750	0.946	174	0.43	29	0.008	-12	0.932	177
800	0.951	174	0.39	26	0.007	-9	0.933	176
850	0.953	173	0.36	24	0.007	-4	0.939	175
900	0.954	172	0.33	22	0.006	6	0.942	175
950	0.955	172	0.30	19	0.006	9	0.944	174
1000	0.958	171	0.28	17	0.006	15	0.943	174
1050	0.958	170	0.26	15	0.005	23	0.950	173
1100	0.957	170	0.24	13	0.006	31	0.947	173
1150	0.959	169	0.23	11	0.006	40	0.946	172
1200	0.969	169	0.21	10	0.006	46	0.950	172
1250	0.961	168	0.20	8	0.007	50	0.953	171
1300	0.960	167	0.19	5	0.008	51	0.954	171
1350	0.958	167	0.18	3	0.008	54	0.951	170
1400	0.959	166	0.16	1	0.008	61	0.950	169
1450	0.958	166	0.15	1	0.009	67	0.951	169
1500	0.953	165	0.14	0	0.009	80	0.950	168

Obsolete Product



COMMON SOURCE S-PARAMETER (PD54008)

(V_{DS} = 7.5V I_{DS} = 1.5A)

FREQ (MHz)	S ₁₁	∠S ₁₁	S ₂₁	∠S ₂₁	S ₁₂	∠S ₁₂	S ₂₂	∠S ₂₂
50	0.852	-174	8.94	84	0.014	-1	0.885	-175
100	0.896	-176	4.37	80	0.014	-5	0.887	-178
150	0.917	-178	2.96	77	0.014	-6	0.886	-179
200	0.923	-180	2.20	73	0.014	-8	0.891	-179
250	0.924	180	1.75	69	0.013	-8	0.891	-180
300	0.927	179	1.44	65	0.013	-10	0.897	180
350	0.930	178	1.21	60	0.012	-11	0.900	179
400	0.931	178	1.04	57	0.012	-13	0.901	179
450	0.933	177	0.91	53	0.011	-12	0.905	179
500	0.936	177	0.79	49	0.010	-11	0.913	178
550	0.938	176	0.70	45	0.010	-10	0.916	178
600	0.942	175	0.63	42	0.009	-10	0.920	177
650	0.945	175	0.57	39	0.008	-8	0.924	177
700	0.947	174	0.51	37	0.008	-4	0.927	177
750	0.947	174	0.47	34	0.008	-1	0.931	176
800	0.951	173	0.43	31	0.007	4	0.932	175
850	0.951	173	0.39	29	0.007	7	0.938	175
900	0.952	172	0.36	26	0.007	14	0.938	175
950	0.955	171	0.33	24	0.007	19	0.940	174
1000	0.957	171	0.31	22	0.006	24	0.941	174
1050	0.957	170	0.29	20	0.007	29	0.946	173
1100	0.957	169	0.27	18	0.007	30	0.947	172
1150	0.956	169	0.25	16	0.007	38	0.945	172
1200	0.958	168	0.24	14	0.007	45	0.947	172
1250	0.957	168	0.23	11	0.008	50	0.950	171
1300	0.958	167	0.21	9	0.008	50	0.952	170
1350	0.957	167	0.20	7	0.008	53	0.946	170
1400	0.957	166	0.18	5	0.008	60	0.949	169
1450	0.957	166	0.17	4	0.010	66	0.948	169
1500	0.952	165	0.16	3	0.009	76	0.948	168

Obsolete Product

PowerSO-10RF Formed Lead (Gull Wing) MECHANICAL DATA

DIM.	mm			Inch		
	MIN.	TYP.	MAX	MIN.	TYP.	MAX
A1	0	0.05	0.1	0.	0.0019	0.0038
A2	3.4	3.5	3.6	0.134	0.137	0.142
A3	1.2	1.3	1.4	0.046	0.05	0.054
A4	0.15	0.2	0.25	0.005	0.007	0.009
a		0.2			0.007	
b	5.4	5.53	5.65	0.212	0.217	0.221
c	0.23	0.27	0.32	0.008	0.01	0.012
D	9.4	9.5	9.6	0.370	0.374	0.377
D1	7.4	7.5	7.6	0.290	0.295	0.298
E	13.85	14.1	14.35	0.544	0.555	0.565
E1	9.3	9.4	9.5	0.365	0.37	0.375
E2	7.3	7.4	7.5	0.286	0.292	0.294
E3	5.9	6.1	6.3	0.231	0.24	0.247
F		0.5			0.019	
G		1.2			0.047	
L	0.8	1	1.1	0.030	0.039	0.042
R1			0.25			0.01
R2		0.8			0.031	
T	2 deg	5 deg	8 deg	2 deg	5 deg	8 deg
T1		6 deg			6 deg	
T2		10 deg			10 deg	

Note (1): Resin protrusions not included (max value: 0.15 mm per side)

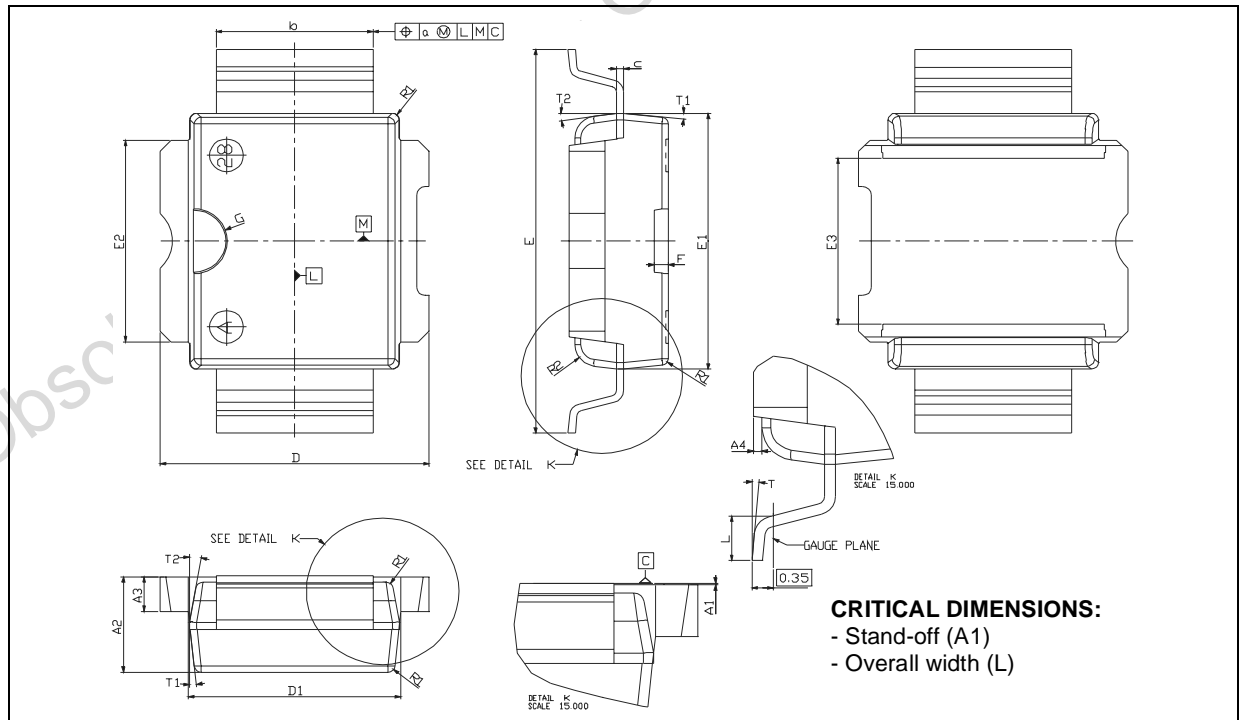

PowerSO-10RF Straight Lead MECHANICAL DATA

DIM.	mm			Inch		
	MIN.	TYP.	MAX	MIN.	TYP.	MAX
A1	1.62	1.67	1.72	0.064	0.065	0.068
A2	3.4	3.5	3.6	0.134	0.137	0.142
A3	1.2	1.3	1.4	0.046	0.05	0.054
A4	0.15	0.2	0.25	0.005	0.007	0.009
a		0.2			0.007	
b	5.4	5.53	5.65	0.212	0.217	0.221
c	0.23	0.27	0.32	0.008	0.01	0.012
D	9.4	9.5	9.6	0.370	0.374	0.377
D1	7.4	7.5	7.6	0.290	0.295	0.298
E	15.15	15.4	15.65	0.595	0.606	0.615
E1	9.3	9.4	9.5	0.365	0.37	0.375
E2	7.3	7.4	7.5	0.286	0.292	0.294
E3	5.9	6.1	6.3	0.231	0.24	0.247
F		0.5			0.019	
G		1.2			0.047	
R1			0.25			0.01
R2		0.8			0.031	
T1		6 deg			6 deg	
T2		10 deg			10 deg	

Note (1): Resin protrusions not included (max value: 0.15 mm per side)

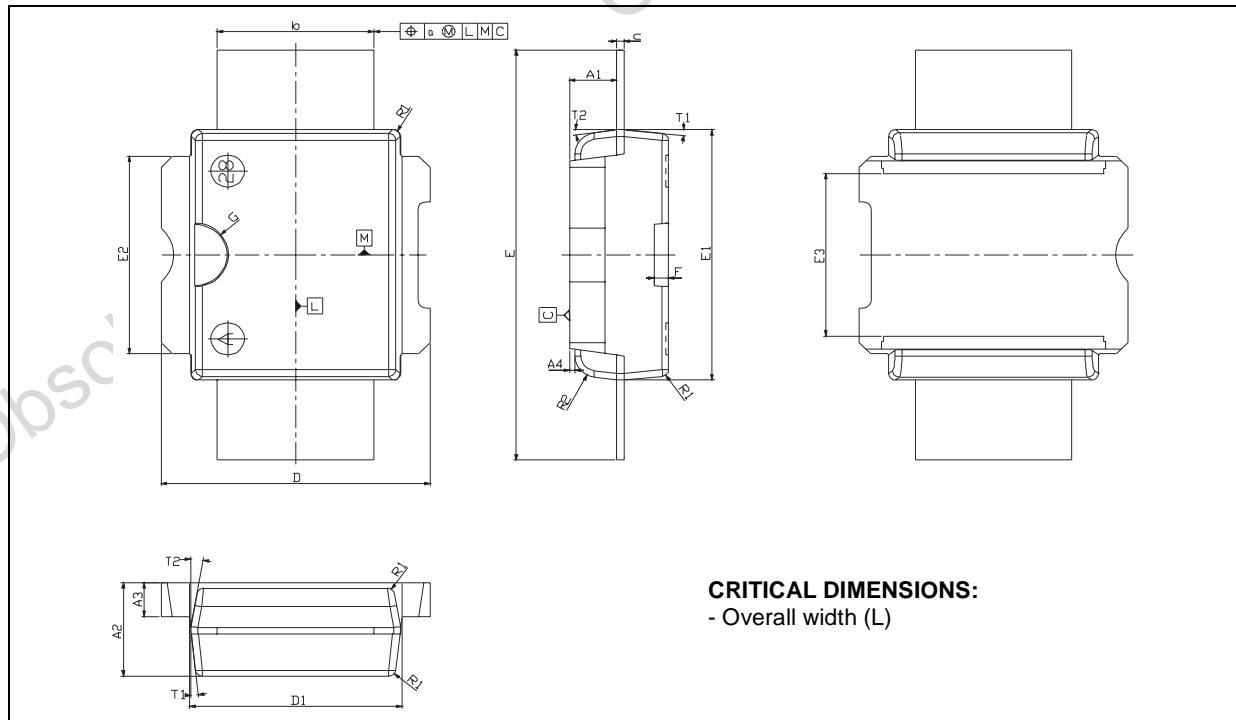

Information furnished is believed to be accurate and reliable. However, STMicroelectronics assumes no responsibility for the consequences of use of such information nor for any infringement of patents or other rights of third parties which may result from its use. No license is granted by implication or otherwise under any patent or patent rights of STMicroelectronics. Specifications mentioned in this publication are subject to change without notice. This publication supersedes and replaces all information previously supplied. STMicroelectronics products are not authorized for use as critical components in life support devices or systems without express written approval of STMicroelectronics.

The ST logo is registered trademark of STMicroelectronics
© 2003 STMicroelectronics - All Rights Reserved

All other names are the property of their respective owners.

STMicroelectronics GROUP OF COMPANIES
Australia - Brazil - Canada - China - Finland - France - Germany - Hong Kong - India - Israel - Italy - Japan -
Malaysia - Malta - Morocco - Singapore - Spain - Sweden - Switzerland - United Kingdom - U.S.A.

<http://www.st.com>