



Chipsmall Limited consists of a professional team with an average of over 10 year of expertise in the distribution of electronic components. Based in Hongkong, we have already established firm and mutual-benefit business relationships with customers from,Europe,America and south Asia,supplying obsolete and hard-to-find components to meet their specific needs.

With the principle of “Quality Parts,Customers Priority,Honest Operation,and Considerate Service”,our business mainly focus on the distribution of electronic components. Line cards we deal with include Microchip,ALPS,ROHM,Xilinx,Pulse,ON,Everlight and Freescale. Main products comprise IC,Modules,Potentiometer,IC Socket,Relay,Connector.Our parts cover such applications as commercial,industrial, and automotives areas.

We are looking forward to setting up business relationship with you and hope to provide you with the best service and solution. Let us make a better world for our industry!



## Contact us

Tel: +86-755-8981 8866 Fax: +86-755-8427 6832

Email & Skype: info@chipsmall.com Web: www.chipsmall.com

Address: A1208, Overseas Decoration Building, #122 Zhenhua RD., Futian, Shenzhen, China





# PD57006 PD57006S

## RF POWER TRANSISTORS The LdmoST Plastic FAMILY

### N-CHANNEL ENHANCEMENT-MODE LATERAL MOSFETs

- EXCELLENT THERMAL STABILITY
- COMMON SOURCE CONFIGURATION
- $P_{OUT} = 6\text{ W}$  with 15 dB gain @ 945 MHz / 28V
- NEW RF PLASTIC PACKAGE

#### DESCRIPTION

The PD57006 is a common source N-Channel, enhancement-mode lateral Field-Effect RF power transistor. It is designed for high gain, broad band commercial and industrial applications. It operates at 28 V in common source mode at frequencies of up to 1 GHz. PD57006 boasts the excellent gain, linearity and reliability of ST's latest LDMOS technology mounted in the first true SMD plastic RF power package, PowerSO-10RF. PD57006's superior linearity performance makes it an ideal solution for car mobile radio.

The PowerSO-10 plastic package, designed to offer high reliability, is the first ST JEDEC approved, high power SMD package. It has been specially optimized for RF needs and offers excellent RF performances and ease of assembly.

*Mounting recommendations are available in [www.st.com/rf/](http://www.st.com/rf/) (look for application note AN1294)*

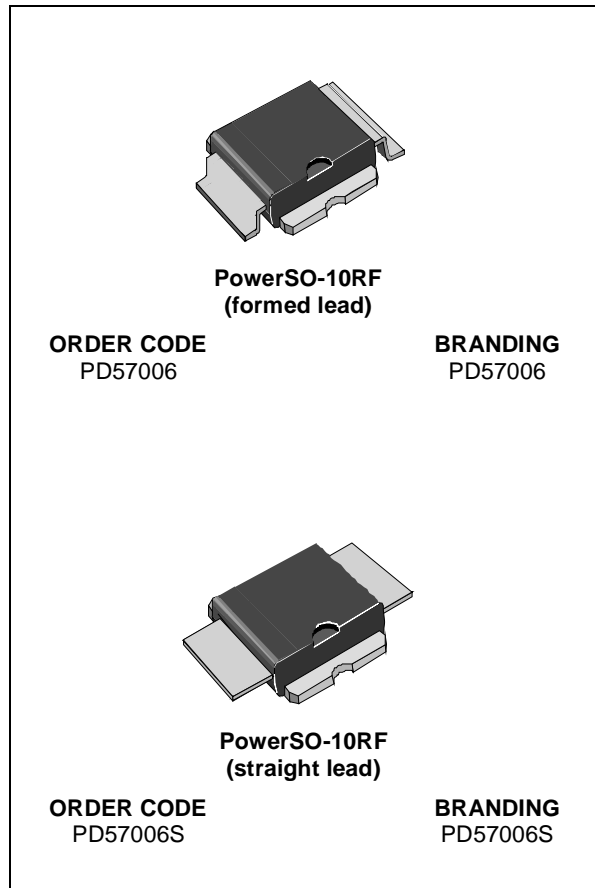

#### ABSOLUTE MAXIMUM RATINGS ( $T_{CASE} = 25^{\circ}\text{C}$ )

Symbol	Parameter	Value	Unit
$V_{(BR)DSS}$	Drain-Source Voltage	65	V
$V_{GS}$	Gate-Source Voltage	$\pm 20$	V
$I_D$	Drain Current	1	A
$P_{DISS}$	Power Dissipation (@ $T_c = 70^{\circ}\text{C}$ )	20	W
$T_j$	Max. Operating Junction Temperature	165	$^{\circ}\text{C}$
$T_{STG}$	Storage Temperature	-65 to +150	$^{\circ}\text{C}$

#### THERMAL DATA

$R_{th(j-c)}$	Junction -Case Thermal Resistance	5	$^{\circ}\text{C}/\text{W}$
---------------	-----------------------------------	---	-----------------------------

# PD57006 - PD57006S

## ELECTRICAL SPECIFICATION (T<sub>CASE</sub> = 25°C)

### STATIC

Symbol	Test Conditions		Min.	Typ.	Max.	Unit
V <sub>(BR)DSS</sub>	V <sub>GS</sub> = 0 V	I <sub>D</sub> = 10 mA	65			
I <sub>DSS</sub>	V <sub>GS</sub> = 0 V	V <sub>DS</sub> = 28 V			1	μA
I <sub>GSS</sub>	V <sub>GS</sub> = 20 V	V <sub>DS</sub> = 0 V			1	μA
V <sub>GS(Q)</sub>	V <sub>DS</sub> = 28 V	I <sub>D</sub> = 70 mA	2.0		5.0	V
V <sub>DS(ON)</sub>	V <sub>GS</sub> = 10 V	I <sub>D</sub> = 0.5 A			0.9	V
g <sub>FS</sub>	V <sub>DS</sub> = 10 V	I <sub>D</sub> = 800 mA		0.58		mho
C <sub>ISS</sub>	V <sub>GS</sub> = 0 V	V <sub>DS</sub> = 28 V		27		pF
C <sub>OSS</sub>	V <sub>GS</sub> = 0 V	V <sub>DS</sub> = 28 V		14		pF
C <sub>RSS</sub>	V <sub>GS</sub> = 0 V	V <sub>DS</sub> = 28 V		0.9		pF

### DYNAMIC

Symbol	Test Conditions			Min.	Typ.	Max.	Unit
P <sub>OUT</sub>	V <sub>DD</sub> = 28 V	I <sub>DQ</sub> = 70 mA	f = 945 MHz	6			W
G <sub>P</sub>	V <sub>DD</sub> = 28 V	I <sub>DQ</sub> = 70 mA	P <sub>OUT</sub> = 6 W f = 945 MHz	14	15		dB
η <sub>D</sub>	V <sub>DD</sub> = 28 V	I <sub>DQ</sub> = 70 mA	P <sub>OUT</sub> = 6 W f = 945 MHz	45	50		%
Load mismatch	V <sub>DD</sub> = 28 V	I <sub>DQ</sub> = 70 mA	P <sub>OUT</sub> = 6 W f = 945 MHz ALL PHASE ANGLES	10:1			VSWR

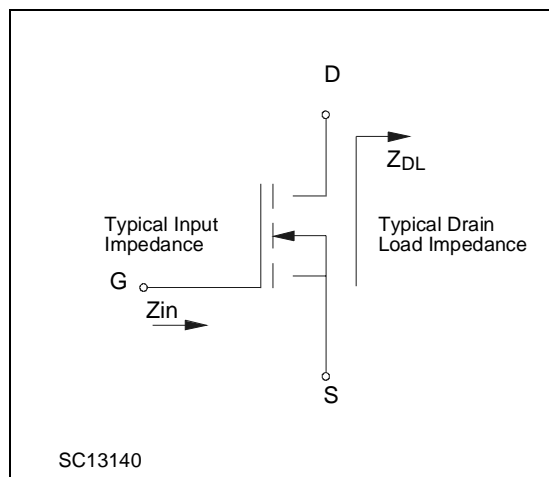
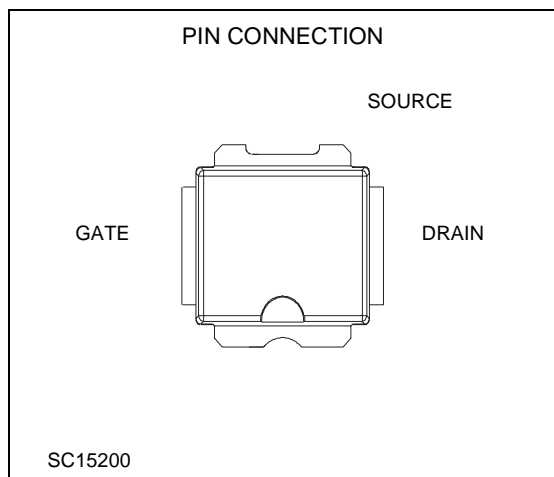

### IMPEDANCE DATA

PD57006

FREQ. MHz	Z <sub>IN</sub> (Ω)	Z <sub>DL</sub> (Ω)
925	6.040 - j 0.936	6.273 + j 8.729
945	5.886 - j 2.326	6.578 + j 5.999
960	6.056 - j 3.522	7.215 + j 7.539

PD57006S

FREQ. MHz	Z <sub>IN</sub> (Ω)	Z <sub>DL</sub> (Ω)
925	3.794 - j 1.632	3.513 + j 10.81
945	4.039 - j 2.300	3.862 + j 10.58
960	4.250 - j 3.791	4.005 + j 11.34

TYPICAL PERFORMANCE

Capacitance vs. Drain Voltage

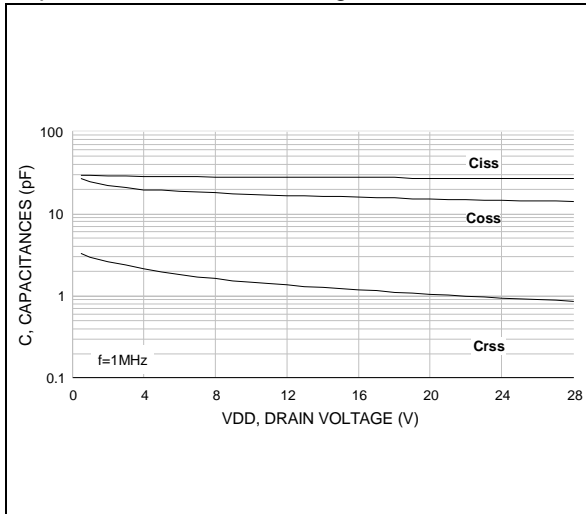

Drain Current vs. Gate-Source Voltage

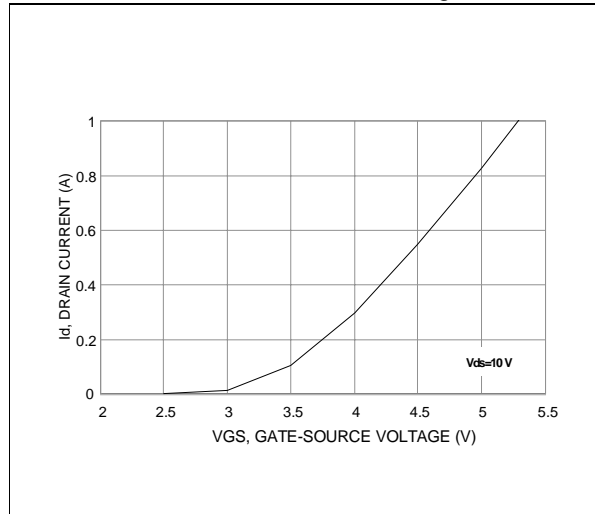

Gate-Source Voltage vs. Case Temperature

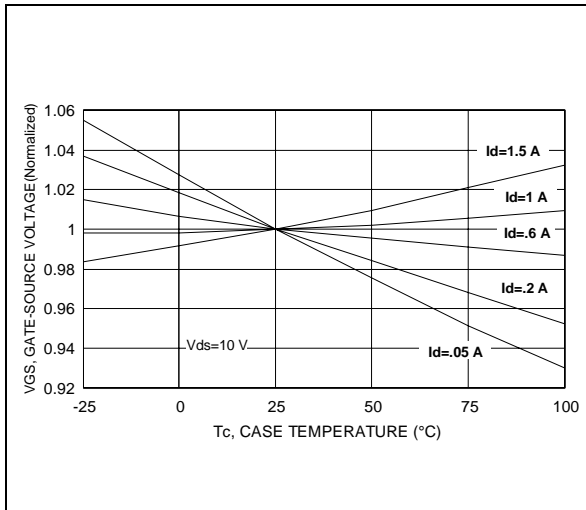

# PD57006 - PD57006S

## TYPICAL PERFORMANCE

### Output Power vs. Input Power

PD57006

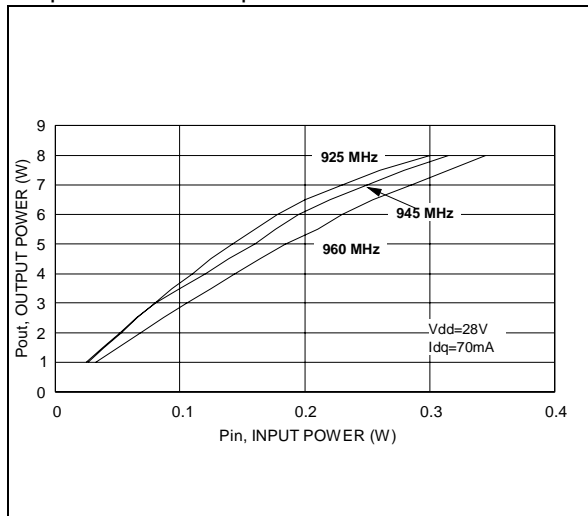

### Power Gain vs. Output Power

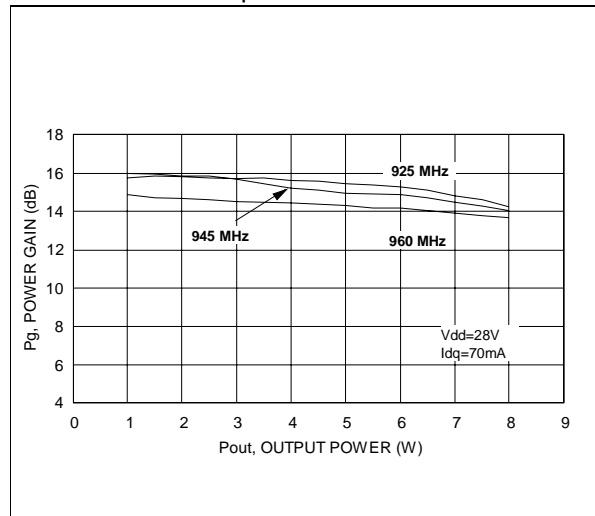

### Drain Efficiency vs. Output Power

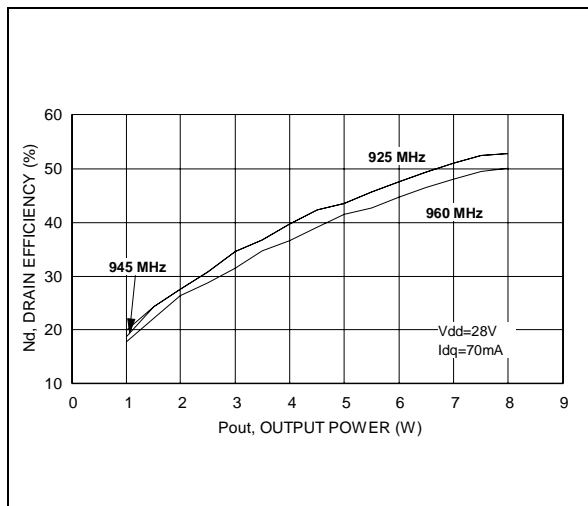

### Input Return Loss vs. Output Power

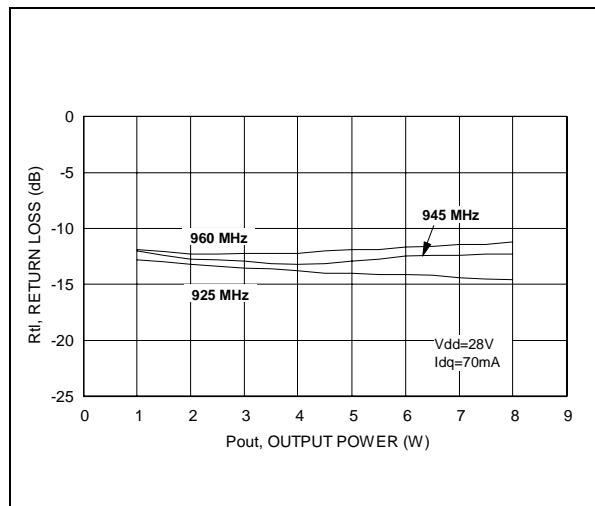

### Output Power vs. Bias Current

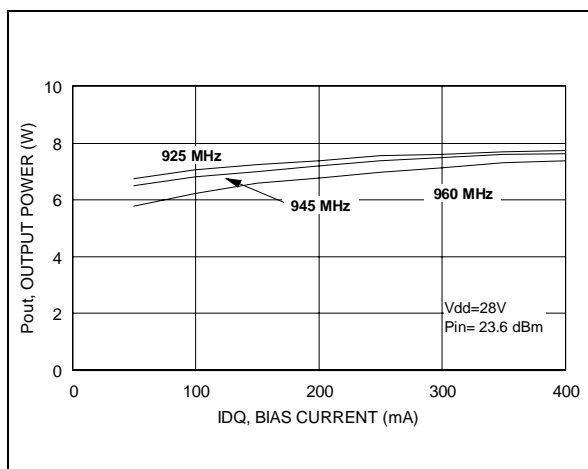

### Drain Efficiency vs. Bias Current

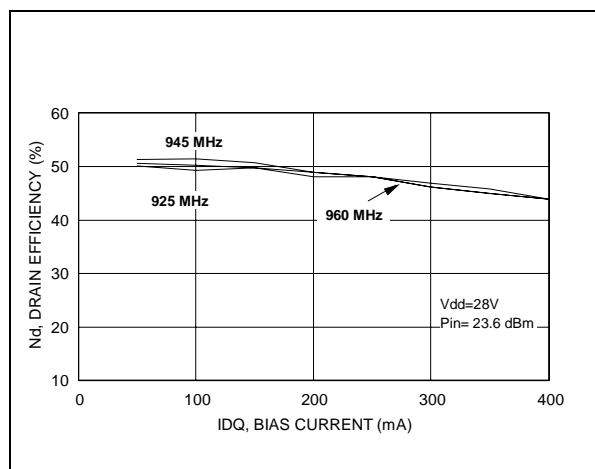

TYPICAL PERFORMANCE

Output Power vs. Supply Voltage

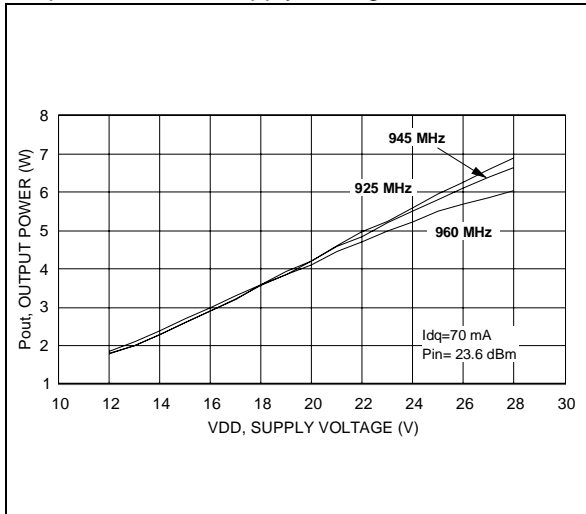

Drain Efficiency vs. Supply Voltage

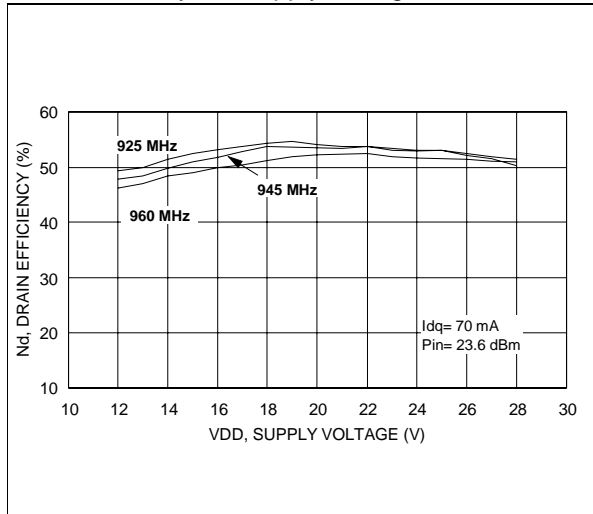

Output Power vs. Gate-Source Voltage

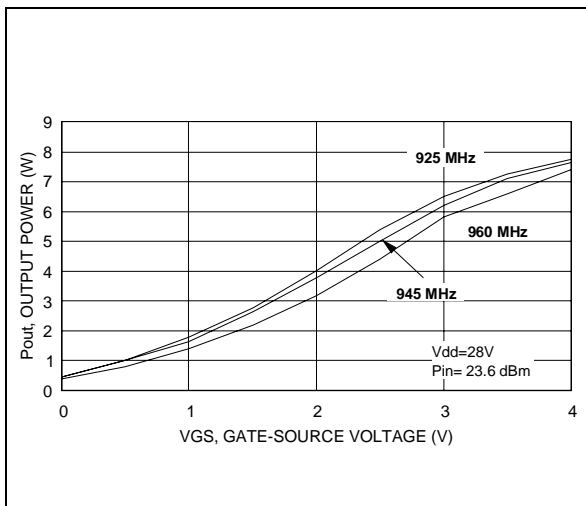

# PD57006 - PD57006S

## TYPICAL PERFORMANCE

Output Power vs. Input Power **PD57006S**

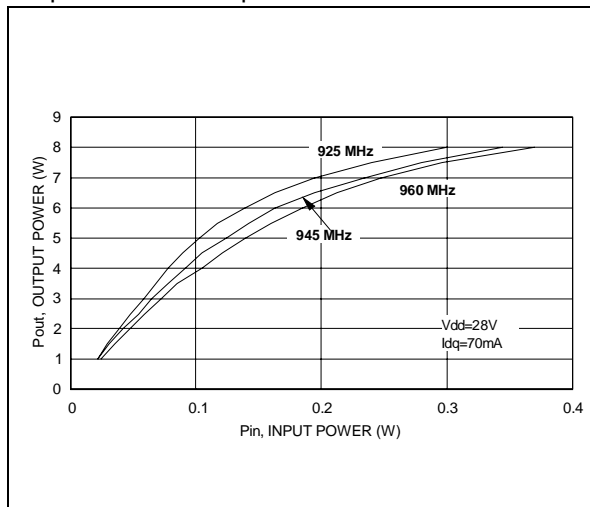

Power Gain vs. Output Power

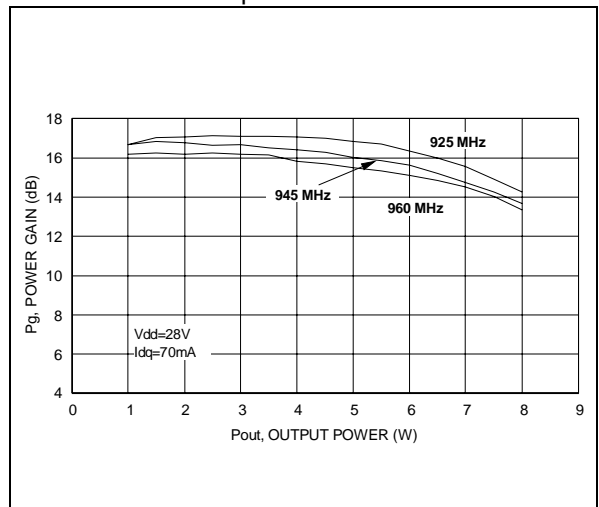

Drain Efficiency vs. Output Power

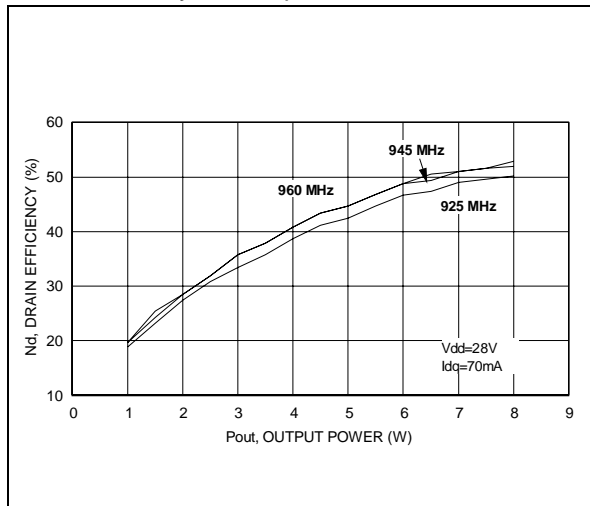

Input Return Loss vs. Output Power

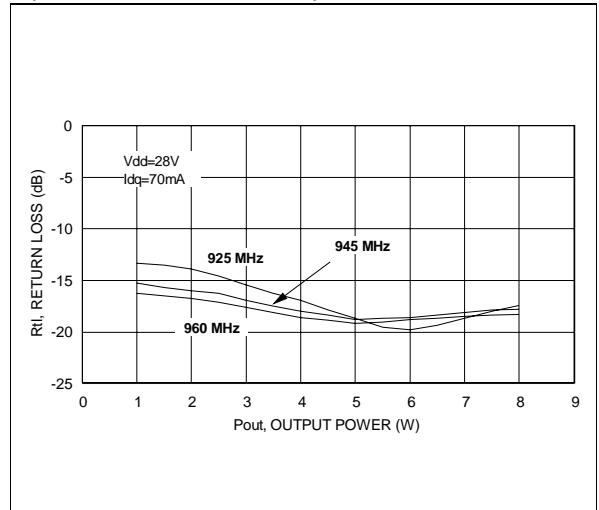

Output Power vs. Bias Current

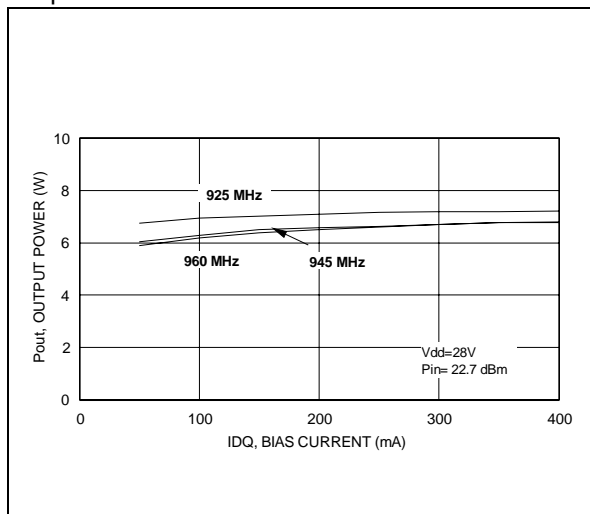

Drain Efficiency vs. Bias Current

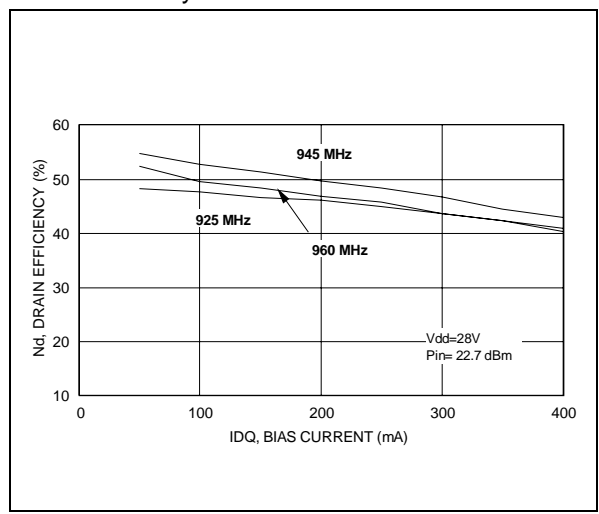

TYPICAL PERFORMANCE

Output Power vs. Supply Voltage

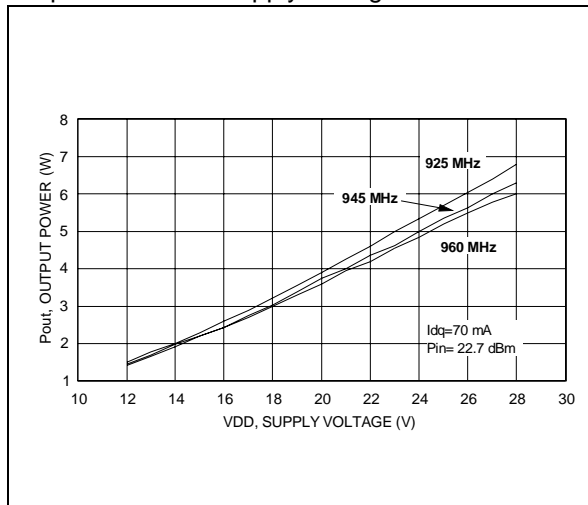

Drain Efficiency vs. Supply Voltage

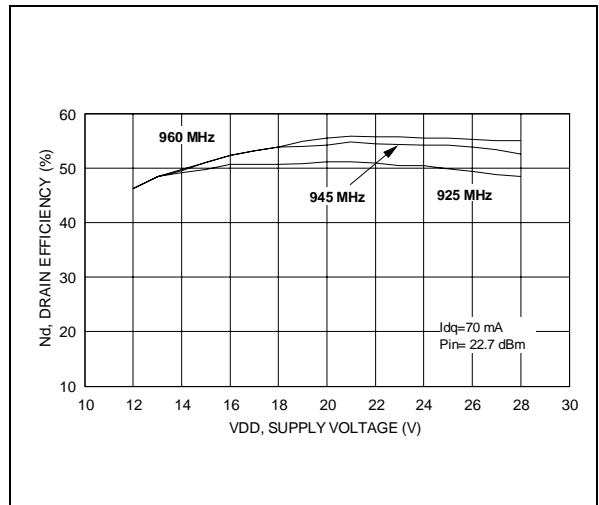

Output Power vs. Gate-Source Voltage

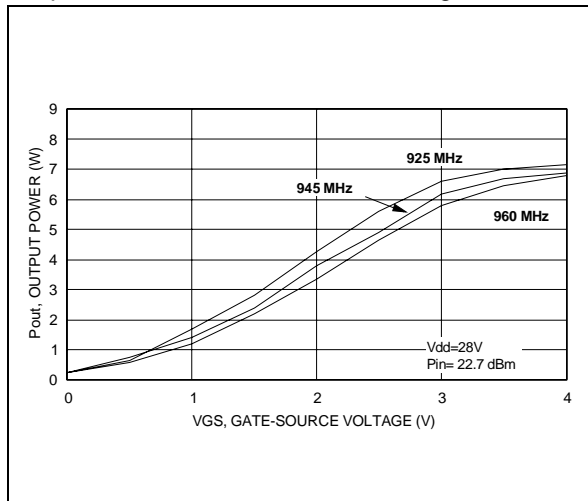



TEST CIRCUIT SCHEMATIC

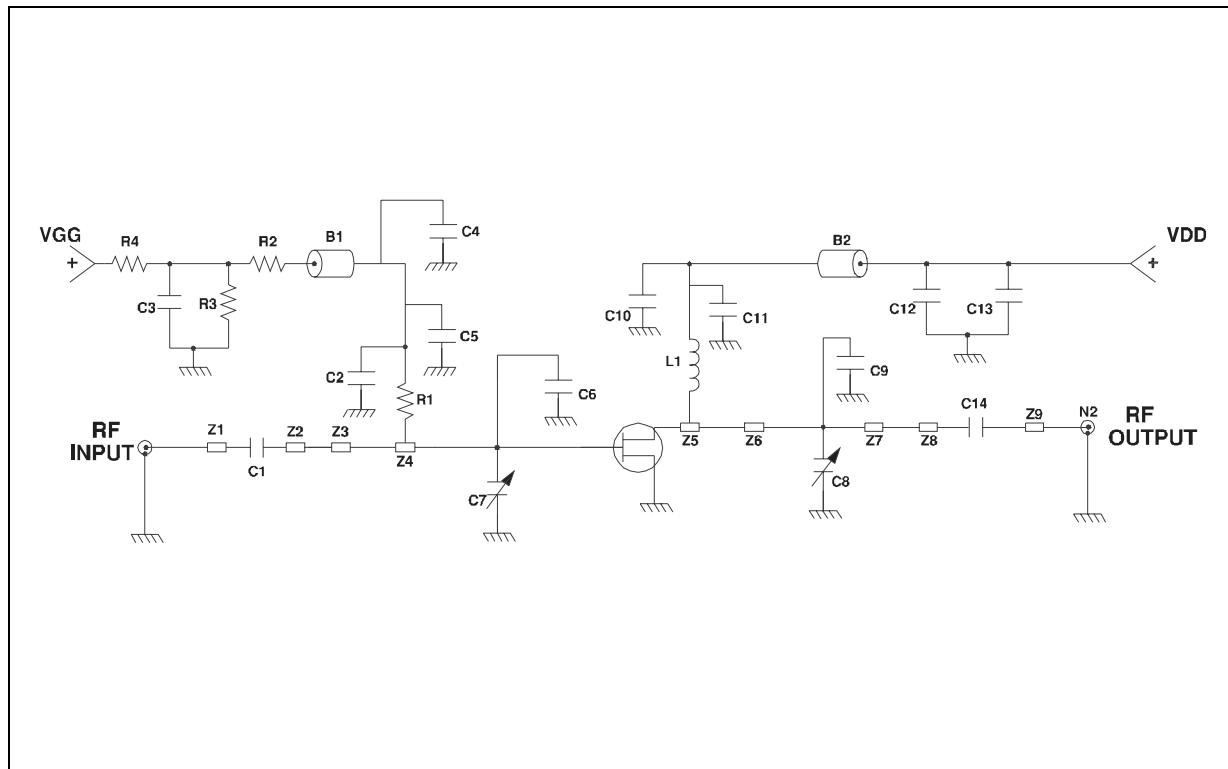

TEST CIRCUIT COMPONENT PART LIST

B1, B2	SHORT FERRITE BEAD, FAIR RITE PRODUCTS (2743021446)	R2	18 kΩ CHIP RESISTOR 1 W
C1, C2, C11, C14	47 pF, 100B ATC CHIP CAPACITOR	R3	4.7 mΩ CHIP RESISTOR 1 W
C5	1000 pF, 100B ATC CHIP CAPACITOR	R4	12 kΩ CHIP RESISTOR 1 W
C4, C12	.01 μF, VENKEL CHIP CAPACITOR	Z1	0.430" X 0.084" MICROSTRIP
C3, C13	220 μF, 63 V ELECTROLYTIC CAPACITOR	Z2	0.1.186" X 1.120" MICROSTRIP
C10	100 pF, 100B ATC CHIP CAPACITOR	Z3	1.273" X 0.565" MICROSTRIP
C9	6.2 pF, 100B ATC CHIP CAPACITOR	Z4	0.770" X 0.171" MICROSTRIP
C7, C8	08-8 pF VARIABLE CAPACITOR JOHANSON	Z5	0.880" X 0.105" MICROSTRIP
L1	15 nH, 3 TURN, .140" DIA. 22 AWG BELDEN 8021 BLIS PER WIRE	Z6	1.200" X 0.084" MICROSTRIP
N1, N2	TYPE N FLANGE MOUNT	BOARD	ROGER ULTRA LAM 2000 THK 0.030" ε <sub>r</sub> = 2.55 2oz ED Cu BOTH SIDES
R1	100 Ω CHIP RESISTOR 1 W		

TEST CIRCUIT PHOTOMASTER

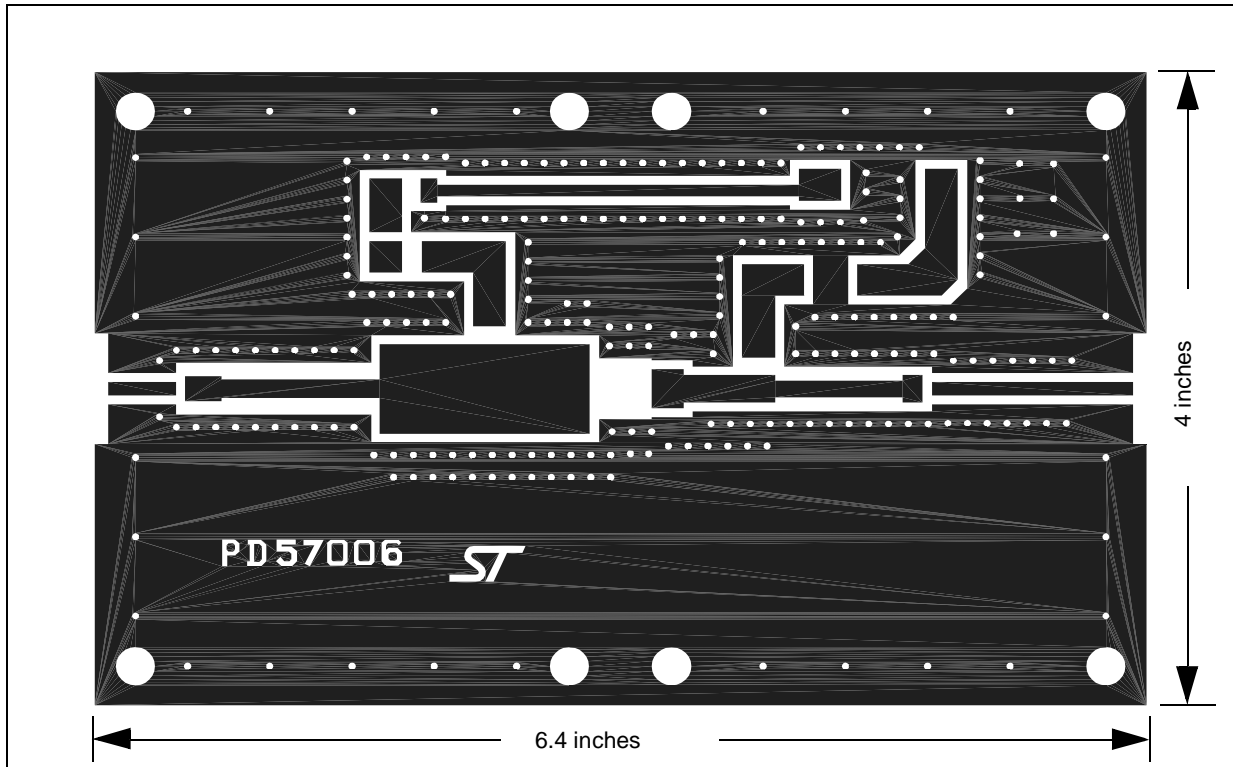

TEST CIRCUIT

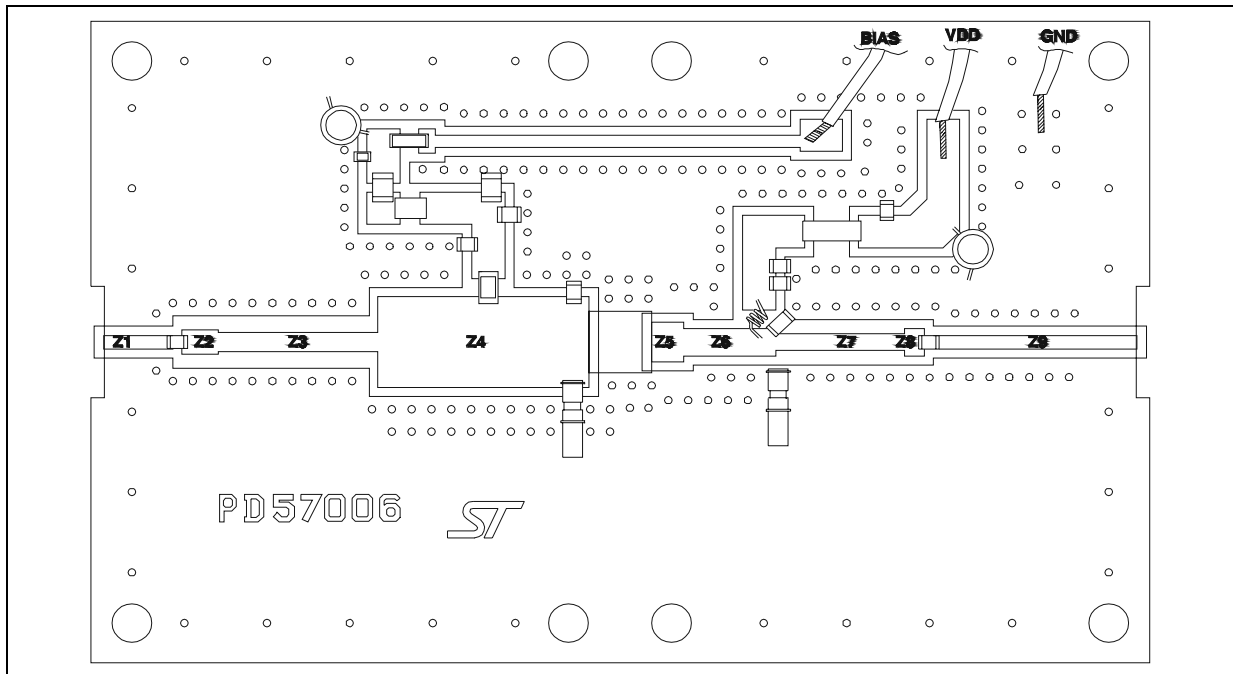

TRANSMISSION LINE DIMENSIONS

Z1	0.430" X 0.084" MICROSTRIP	Z4	1.273" X 0.565" MICROSTRIP	Z7	0.778" X 0.150" MICROSTRIP
Z2	0.220" X 0.155" MICROSTRIP	Z5	0.195" X 0.250" MICROSTRIP	Z8	0.120" X 0.171" MICROSTRIP
Z3	0.960" X 0.120" MICROSTRIP	Z6	0.555" X 0.171" MICROSTRIP	Z8	1.200" X 0.084" MICROSTRIP

**COMMON SOURCE S-PARAMETER (PD57006)**

( $V_{DS} = 13.5V$   $I_{DS} = 0.2A$ )

FREQ (MHz)	$ S_{11} $	$\angle S_{11}$	$ S_{21} $	$\angle S_{21}$	$ S_{12} $	$\angle S_{12}$	$ S_{22} $	$\angle S_{22}$
50	0.895	-79	29.76	130	0.033	39	0.814	-70
100	0.786	-118	18.68	102	0.041	13	0.699	-106
150	0.765	-134	12.61	90	0.042	2	0.621	-121
200	0.767	-143	9.22	80	0.041	-8	0.629	-132
250	0.778	-151	7.50	73	0.041	-15	0.629	-136
300	0.790	-156	6.09	66	0.038	-22	0.650	-141
350	0.794	-159	5.23	59	0.038	-28	0.685	-143
400	0.806	-162	4.39	54	0.036	-32	0.700	-147
450	0.814	-165	3.82	48	0.035	-37	0.724	-149
500	0.826	-167	3.30	43	0.033	-41	0.749	-152
550	0.836	-170	2.90	38	0.031	-45	0.771	-154
600	0.843	-172	2.59	34	0.029	-49	0.785	-1564
650	0.850	-174	2.32	31	0.028	-53	0.803	-158
700	0.857	-176	2.09	27	0.027	-56	0.814	-1598
750	0.863	-178	1.91	23	0.025	-59	0.829	-162
800	0.869	-180	1.76	20	0.024	-62	0.839	-163
850	0.869	178	1.61	16	0.023	-64	0.847	-165
900	0.872	177	1.50	13	0.022	-68	0.859	-166
950	0.875	175	1.40	10	0.020	-72	0.868	-168
1000	0.873	173	1.32	7	0.020	-75	0.873	-169
1050	0.875	172	1.24	3	0.019	-78	0.885	-171
1100	0.872	170	1.18	0	0.019	-81	0.886	-172
1150	0.871	168	1.12	-4	0.018	-86	0.889	-174
1200	0.864	166	1.08	-7	0.017	-92	0.890	-175
1250	0.861	164	1.03	-11	0.016	-97	0.895	-177
1300	0.855	163	1.00	-15	0.016	-102	0.896	-178
1350	0.847	160	0.96	-19	0.015	-108	0.895	-180
1400	0.835	158	0.93	-23	0.015	-111	0.897	179
1450	0.818	156	0.89	-27	0.015	-120	0.896	178
1500	0.797	153	0.88	-31	0.016	-128	0.899	177

**COMMON SOURCE S-PARAMETER (PD57006)**

( $V_{DS} = 28V$   $I_{DS} = 0.2A$ )

FREQ (MHz)	$ S_{11} $	$S_{11}\angle\Phi$	$ S_{21} $	$S_{21}\angle\Phi$	$ S_{12} $	$S_{12}\angle\Phi$	$ S_{22} $	$S_{22}\angle\Phi$
50	0.953	-65	31.01	138	0.022	48	0.780	-52
100	0.855	-104	21.59	112	0.030	20	0.677	-85
150	0.823	-124	15.49	96	0.031	7	0.601	-101
200	0.818	-136	11.84	85	0.031	-5	0.605	-113
250	0.824	-144	9.54	75	0.031	-12	0.614	-118
300	0.832	-150	7.85	67	0.029	-19	0.635	-126
350	0.835	-155	6.48	59	0.029	-25	0.676	-129
400	0.845	-159	5.51	53	0.027	-31	0.696	-134
450	0.850	-162	4.69	4	0.025	-36	0.722	-137
500	0.860	-165	4.11	43	0.024	-41	0.748	-141
550	0.866	-168	3.58	38	0.023	-44	0.773	-144
600	0.870	-170	3.21	33	0.021	-48	0.790	-147
650	0.878	-172	2.88	29	0.019	-53	0.808	-150
700	0.883	-174	2.60	25	0.019	-53	0.821	-152
750	0.887	-177	2.37	21	0.016	-59	0.838	-154
800	0.890	-179	2.16	17	0.017	-60	0.846	-156
850	0.890	179	1.98	13	0.015	-62	0.856	-158
900	0.888	178	1.82	9	0.014	-67	0.869	-160
950	0.892	176	1.69	6	0.013	-70	0.879	-162
1000	0.894	174	1.57	3	0.013	-72	0.886	-163
1050	0.892	172	1.47	0	0.011	-76	0.892	-165
1100	0.888	170	1.36	-3	0.011	-80	0.894	-166
1150	0.885	169	1.28	-6	0.010	-86	0.899	-168
1200	0.880	167	1.21	-9	0.009	-89	0.897	-170
1250	0.872	165	1.16	-11	0.009	-95	0.901	-171
1300	0.864	163	1.11	-14	0.008	-103	0.906	-173
1350	0.856	161	1.09	-17	0.007	-110	0.905	-174
1400	0.844	159	1.06	-20	0.007	-118	0.905	-176
1450	0.824	156	1.06	-23	0.007	-129	0.906	-177
1500	0.806	154	1.04	-29	0.008	-143	0.910	-178

**PowerSO-10RF Formed Lead (Gull Wing) MECHANICAL DATA**

DIM.	mm			Inch		
	MIN.	TYP.	MAX	MIN.	TYP.	MAX
A1	0	0.05	0.1	0.	0.0019	0.0038
A2	3.4	3.5	3.6	0.134	0.137	0.142
A3	1.2	1.3	1.4	0.046	0.05	0.054
A4	0.15	0.2	0.25	0.005	0.007	0.009
a		0.2			0.007	
b	5.4	5.53	5.65	0.212	0.217	0.221
c	0.23	0.27	0.32	0.008	0.01	0.012
D	9.4	9.5	9.6	0.370	0.374	0.377
D1	7.4	7.5	7.6	0.290	0.295	0.298
E	13.85	14.1	14.35	0.544	0.555	0.565
E1	9.3	9.4	9.5	0.365	0.37	0.375
E2	7.3	7.4	7.5	0.286	0.292	0.294
E3	5.9	6.1	6.3	0.231	0.24	0.247
F		0.5			0.019	
G		1.2			0.047	
L	0.8	1	1.1	0.030	0.039	0.042
R1			0.25			0.01
R2		0.8			0.031	
T	2 deg	5 deg	8 deg	2 deg	5 deg	8 deg
T1		6 deg			6 deg	
T2		10 deg			10 deg	

Note (1): Resin protrusions not included (max value: 0.15 mm per side)

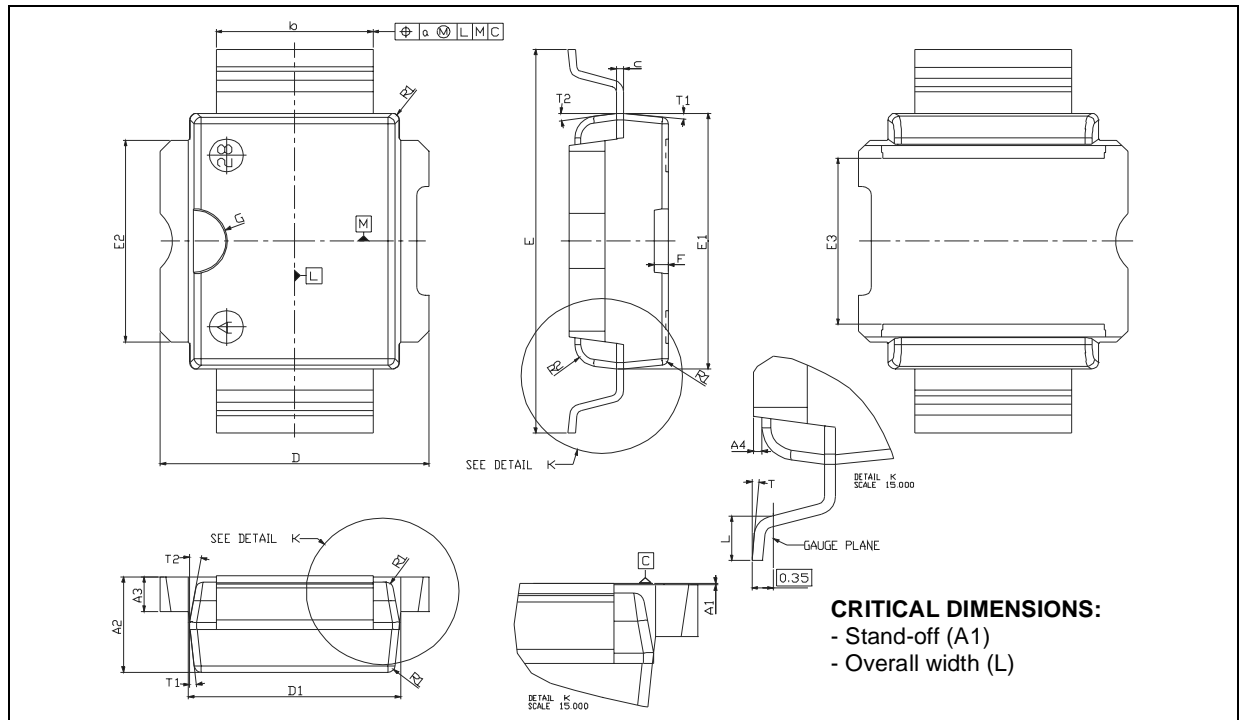

**PowerSO-10RF Straight Lead MECHANICAL DATA**

DIM.	mm			Inch		
	MIN.	TYP.	MAX	MIN.	TYP.	MAX
A1	1.62	1.67	1.72	0.064	0.065	0.068
A2	3.4	3.5	3.6	0.134	0.137	0.142
A3	1.2	1.3	1.4	0.046	0.05	0.054
A4	0.15	0.2	0.25	0.005	0.007	0.009
a		0.2			0.007	
b	5.4	5.53	5.65	0.212	0.217	0.221
c	0.23	0.27	0.32	0.008	0.01	0.012
D	9.4	9.5	9.6	0.370	0.374	0.377
D1	7.4	7.5	7.6	0.290	0.295	0.298
E	15.15	15.4	15.65	0.595	0.606	0.615
E1	9.3	9.4	9.5	0.365	0.37	0.375
E2	7.3	7.4	7.5	0.286	0.292	0.294
E3	5.9	6.1	6.3	0.231	0.24	0.247
F		0.5			0.019	
G		1.2			0.047	
R1			0.25			0.01
R2		0.8			0.031	
T1		6 deg			6 deg	
T2		10 deg			10 deg	

Note (1): Resin protrusions not included (max value: 0.15 mm per side)

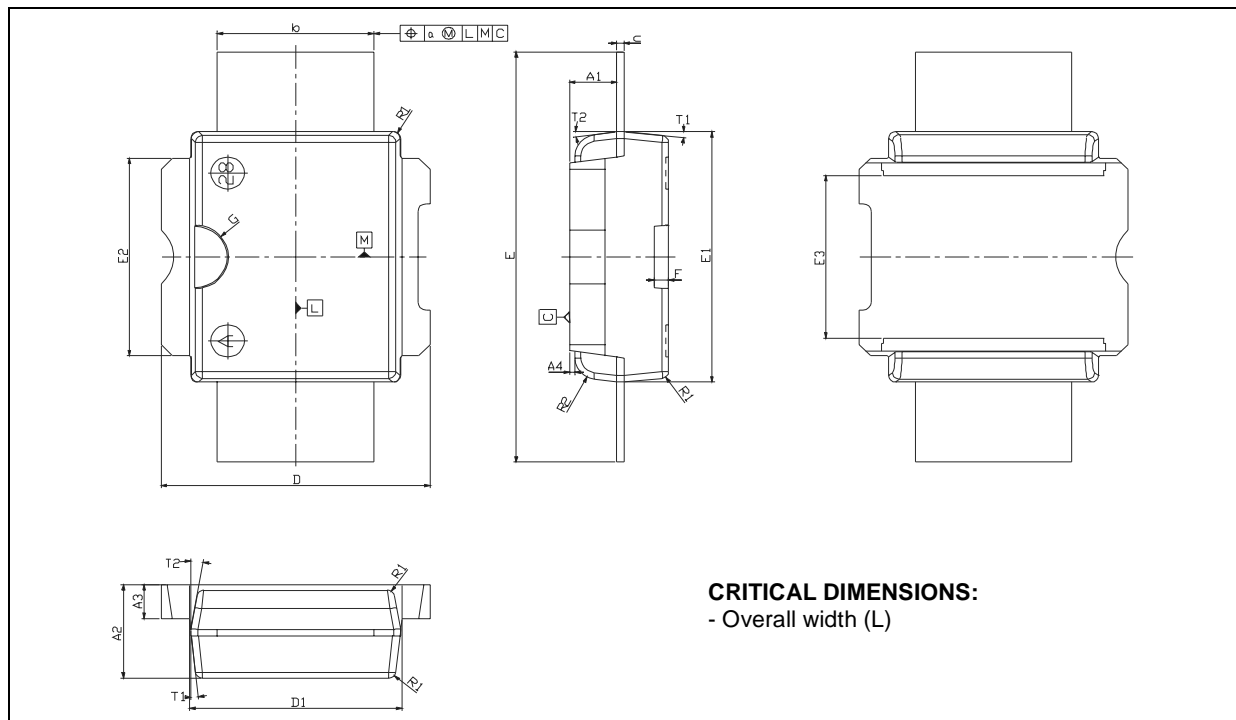

Information furnished is believed to be accurate and reliable. However, STMicroelectronics assumes no responsibility for the consequences of use of such information nor for any infringement of patents or other rights of third parties which may result from its use. No license is granted by implication or otherwise under any patent or patent rights of STMicroelectronics. Specifications mentioned in this publication are subject to change without notice. This publication supersedes and replaces all information previously supplied. STMicroelectronics products are not authorized for use as critical components in life support devices or systems without express written approval of STMicroelectronics.

The ST logo is registered trademark of STMicroelectronics  
© 2003 STMicroelectronics - All Rights Reserved

All other names are the property of their respective owners.

STMicroelectronics GROUP OF COMPANIES  
Australia - Brazil - China - Finland - France - Germany - Hong Kong - India - Italy - Japan - Malaysia - Malta - Morocco -  
Singapore - Spain - Sweden - Switzerland - United Kingdom - U.S.A.

<http://www.st.com>