



Chipsmall Limited consists of a professional team with an average of over 10 year of expertise in the distribution of electronic components. Based in Hongkong, we have already established firm and mutual-benefit business relationships with customers from,Europe,America and south Asia,supplying obsolete and hard-to-find components to meet their specific needs.

With the principle of “Quality Parts,Customers Priority,Honest Operation,and Considerate Service”,our business mainly focus on the distribution of electronic components. Line cards we deal with include Microchip,ALPS,ROHM,Xilinx,Pulse,ON,Everlight and Freescale. Main products comprise IC,Modules,Potentiometer,IC Socket,Relay,Connector.Our parts cover such applications as commercial,industrial, and automotives areas.

We are looking forward to setting up business relationship with you and hope to provide you with the best service and solution. Let us make a better world for our industry!



Contact us

Tel: +86-755-8981 8866 Fax: +86-755-8427 6832

Email & Skype: info@chipsmall.com Web: www.chipsmall.com

Address: A1208, Overseas Decoration Building, #122 Zhenhua RD., Futian, Shenzhen, China



MODEL:

PDUMV30

Metered Rackmount PDU



Low Voltage
Input/Output



24 Outlets



30A Max Capacity



2 Load Meters



0U Rackmount



Toolless
Mounting Buttons

- A** Digital Load Meters
- B** 5-15/20R Outlets
- C** 20A Circuit Breakers
- D** Removable Cord Retention Brackets
- E** Removable Mounting Brackets
- F** Toolless Mounting Buttons
- G** 10 ft. Input Power Cord
- H** L5-30P Twist-Lock Input Plug
- I** Durable Metal Case

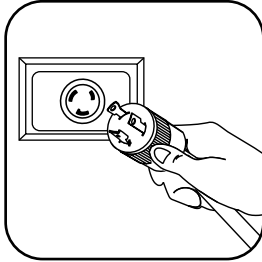

AC Input Connection: Insert L5-30P twist-lock plug into compatible L5-30R utility, generator or UPS outlet.

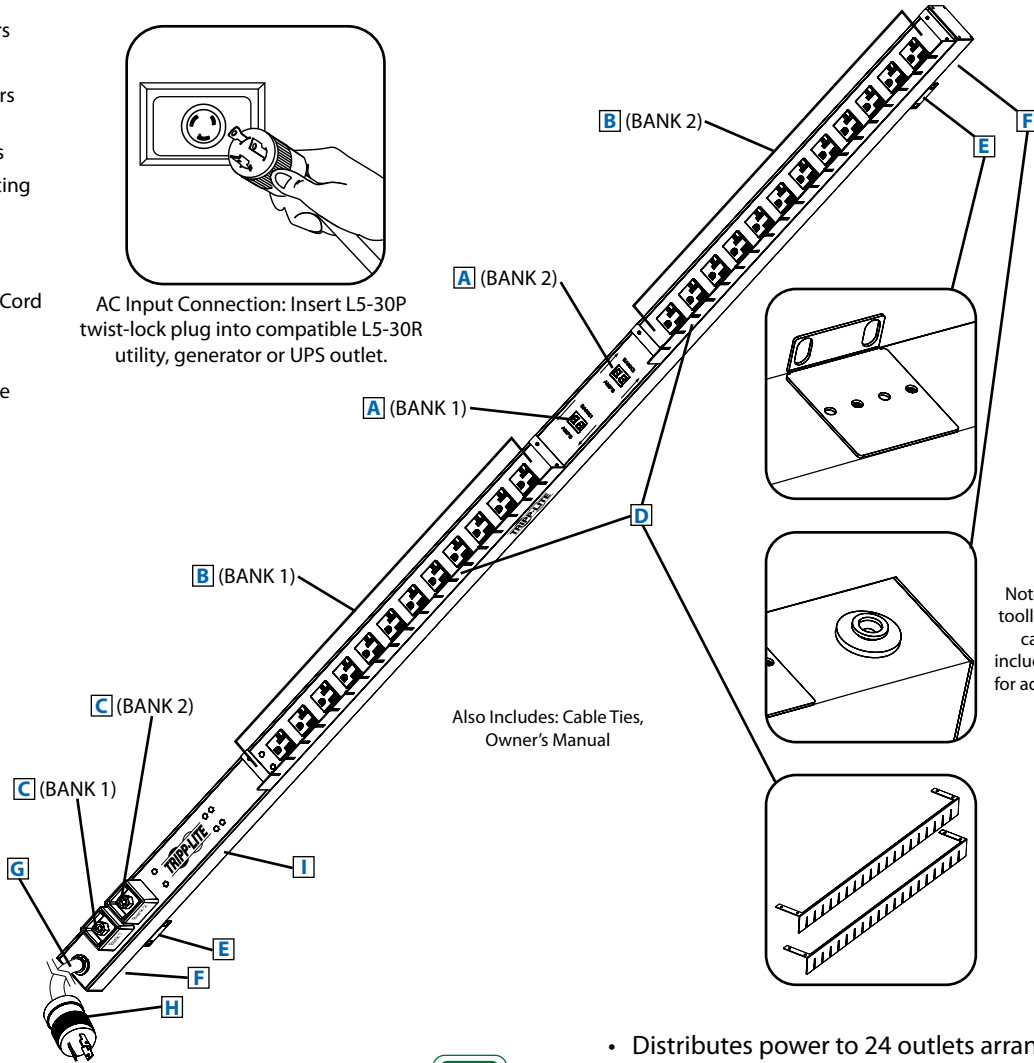

Also Includes: Cable Ties,
Owner's Manual

Note: Installed 17.67 mm
toolless mounting buttons
can be replaced with
included 14.17 mm buttons
for additional compatibility.

Specifications

Model	PDUMV30
Voltage	100-125V
Frequency	50/60 Hz
Maximum Capacity	30A
Agency-Derated Capacity	24A
Input Connector	L5-30P
Cord Length	10 ft.
Outlets	24 (5-15/20R)
Primary Mounting Option	0U (Vertical) Rackmount
Unit Weight & Dimensions	8.0 lb / 3.75 x 63.75 x 2.25 in.
<i>See next page for detailed unit measurements.</i>	
Certifications	Tested to UL 60950-1 (US & Canada), NOM (Mexico)

Tripp Lite has a policy of continuous improvement. Specifications are subject to change without notice.



- Distributes power to 24 outlets arranged in two banks
- Displays total load for each outlet bank in real time
- Perfect for rackmount server, network and telecom applications

SEE NEXT PAGE FOR DETAILED UNIT MEASUREMENTS



1111 W. 35th Street
Chicago, IL 60609 USA
773.869.1234
www.tripplite.com

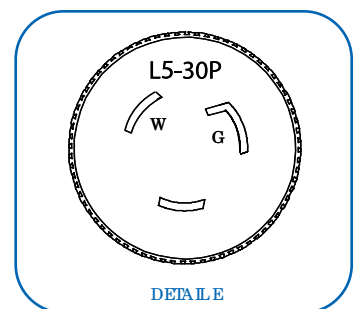
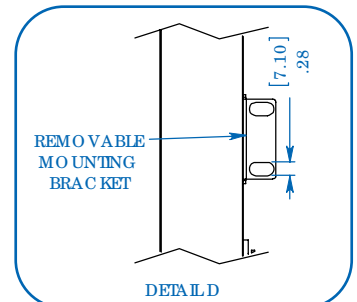
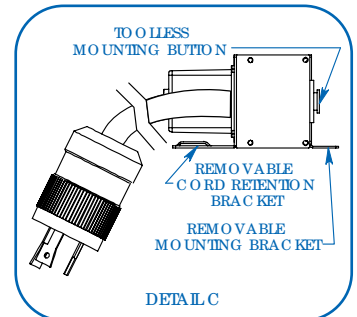
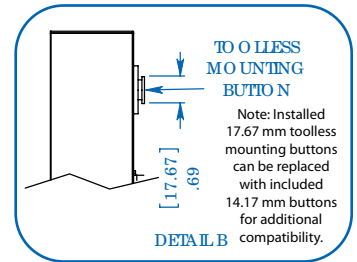
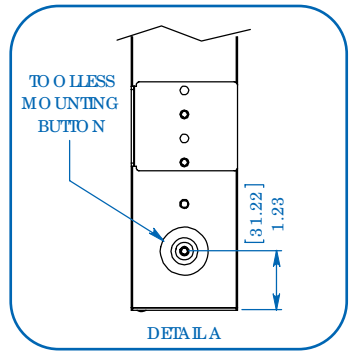
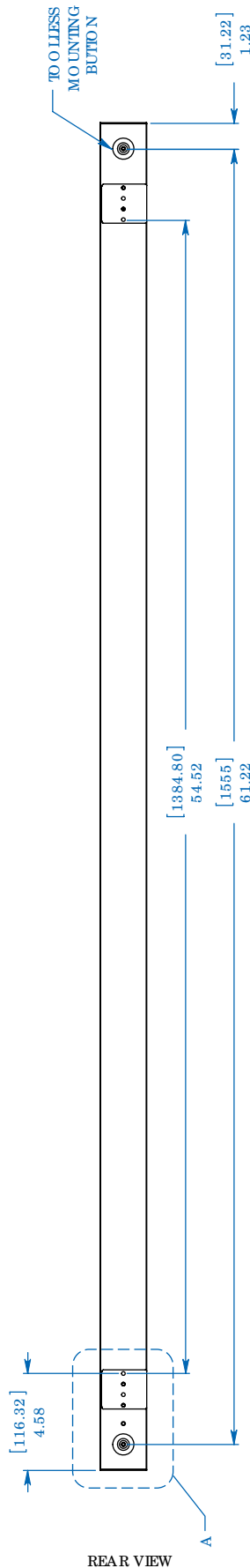
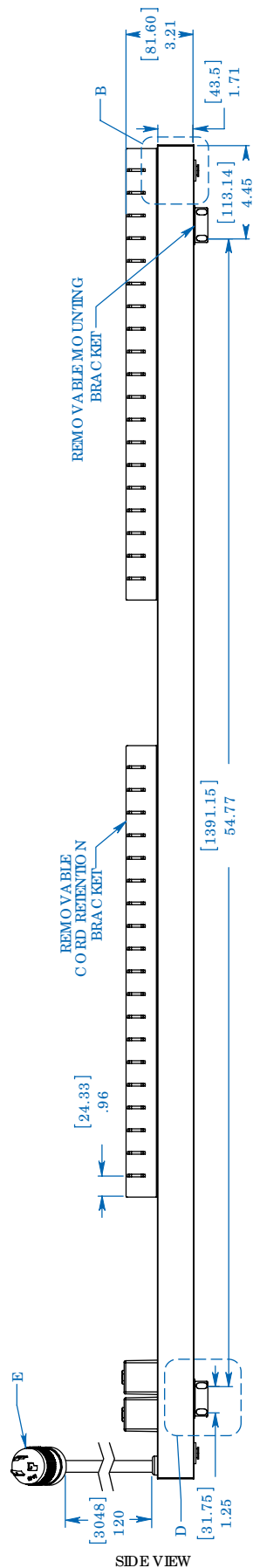
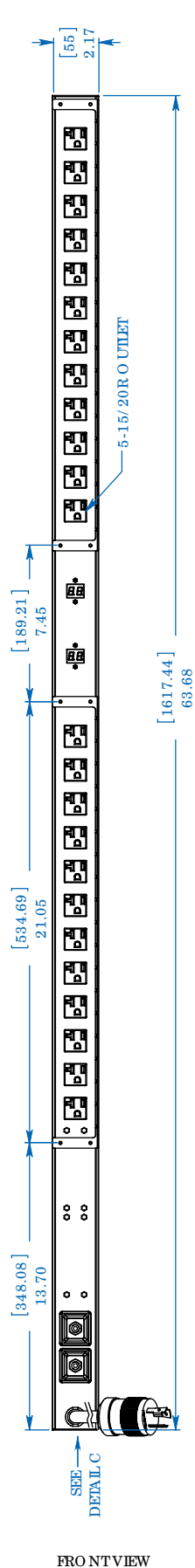

MODEL:
PDUMV30

TRIPP·LITE

1111 W. 35th Street
Chicago, IL 60609 USA
773.869.1234

www.triplite.com

Dimensions: [mm] INCHES

Tripp Lite has a policy of continuous improvement. Specifications are subject to change without notice.