



Chipsmall Limited consists of a professional team with an average of over 10 year of expertise in the distribution of electronic components. Based in Hongkong, we have already established firm and mutual-benefit business relationships with customers from,Europe,America and south Asia,supplying obsolete and hard-to-find components to meet their specific needs.

With the principle of “Quality Parts,Customers Priority,Honest Operation,and Considerate Service”,our business mainly focus on the distribution of electronic components. Line cards we deal with include Microchip,ALPS,ROHM,Xilinx,Pulse,ON,Everlight and Freescale. Main products comprise IC,Modules,Potentiometer,IC Socket,Relay,Connector.Our parts cover such applications as commercial,industrial, and automotives areas.

We are looking forward to setting up business relationship with you and hope to provide you with the best service and solution. Let us make a better world for our industry!



Contact us

Tel: +86-755-8981 8866 Fax: +86-755-8427 6832

Email & Skype: info@chipsmall.com Web: www.chipsmall.com

Address: A1208, Overseas Decoration Building, #122 Zhenhua RD., Futian, Shenzhen, China



Photoelectrics Through-beam, Transistor Output Type PE12CNT15..

CARLO GAVAZZI



- Elevators, Escalators and Entrance control
- Range 15 m
- ESPE-Type 2, PL C.
- Modulated, infrared light
- Supply voltage: 10 to 30 VDC
- Output: 100 mA, NPN or PNP type
- Make or break switching
- LED for output indication or power supply
- Protection: reverse polarity, short circuit, transients
- Cable versions with or without connector
- Emitter mute and power adjustment
- CE, UL325 and UL508 approved



Product Description

The PE12CNT. is a family of general purpose Photoelectric sensors. They are specially designed for Elevators, Escalators, Entrance control to meet the requirements in the door market. The "snap-on"

housing can be mounted with a wall thickness from 0.6 mm to 2.25 mm. The emitter has a mute input to turn it off for evaluation of the sensor function. Available in 10-30 VDC version.

Ordering Key

PE12CNT15NO-C2

Type	PE12CNT15NO-C2
Housing style	PE12CNT15NO-C2
Housing size	PE12CNT15NO-C2
Housing material	PE12CNT15NO-C2
Sensor code	PE12CNT15NO-C2
Detection principle	PE12CNT15NO-C2
Sensing distance	PE12CNT15NO-C2
Output type	PE12CNT15NO-C2
Output configuration	PE12CNT15NO-C2
Connection type	PE12CNT15NO-C2
Cable connector	PE12CNT15NO-C2

Type Selection

Housing diameter	Range S _n	Con-nec-tor	Ordering no. Receiver NPN, NO	Ordering no. Receiver NPN, NC	Ordering no. Receiver PNP, NO	Ordering no. Receiver PNP, NC	Ordering no. Emitter
Ø 12 mm	15 m	NO	PE12CNT15NO	PE12CNT15NC	PE12CNT15PO	PE12CNT15PC	PE12CNT15
Ø 12 mm	15 m	YES	PE12CNT15NO-C2	PE12CNT15NC-C2	PE12CNT15PO-C2	PE12CNT15PC-C2	PE12CNT15-C2

Note: Please order emitter and receiver separately

Specifications Emitter

Rated operational volt. (U _B)	10 to 30 VDC	Light type	Infrared, modulated
Ripple (U _{rip})	≤ 10%	Light spot	940 mm @ 9 m
Supply current	≤ 20 mA	Emitter angle	± 3° @ 9 m
Protection	Reverse polarity, transients	Indication function	Power supply ON Mute input ON
Power ON delay (t _v)	≤ 100 ms	Power adjustment	R _x ~ 3 kΩ -10 kΩ
Control input			
Normal oper.	> 1.5 VDC		
Mute	< 1.2 VDC		
Light source	LED, 890 nm		

Specifications Receiver

Rated operating dist. (S_n)	15 m	Utility category	DC12	Control of resistive loads and solid state loads with optical isolation
Blind zone	None		DC13	Control of electromagnets
Temperature drift	≤ 0.4 %/°C	Ambient light	3,000 ... 3,200 K	> 80,000 LUX (EN60947-5-2)
Hysteresis (H)	3 - 20 %	Detection angle		± 2.5° @ 9 m
Rated operational volt. (U_B)	10 to 30 VDC (ripple included)	Operating frequency (f)		100 Hz
Ripple (U_{rrp})	≤ 10 %	Response time	OFF-ON (t _{ON})	≈ 6.5 ms
No load supply current (I_o)	≤ 16 mA		ON-OFF (t _{OFF})	≈ 3.5 ms
Output current		Power ON delay (t_v)		≤ 100 ms
Continuous (I _a)	≤ 100 mA	Output function	NPN or PNP	Make or break (NO or NC)
Short-time (I)	≤ 100 mA, (max. load capacity 100 nF)	Indication function	Output ON	LED, yellow
Minimum operational current (I_m)	0.5 mA			
OFF-state current (I_r)	≤ 100 μA			
Voltage drop (U_d)	≤ 1.6 VDC @ 100 mA			
Protection	Short-circuit, reverse polarity, transients			

General Specifications

Environment		Surge (EN 61000-4-5)	
Overvoltage category	III (IEC 60664/60664A, 60947-1)	Power-supply	> 1 kV (with 500 Ω)
Pollution degree	3 (IEC 60664/60664A, 60947-1)	Sensor output	> 1 kV (with 500 Ω)
Degree of protection	IP67 (IEC 60529; EN60947-1) 1, 2, 12 (NEMA types)	Wire conducted disturbances (EN 61000-4-6)	> 10 Vrms
Temperature		Power-frequency magnetic fields (EN 61000-4-8)	
Operating	-20° to +50°C (-4° to +122°F)	Continuous	> 30 A/m, 38 μ tesla
Storage	-25° to +80°C (-13° to +176°F)	Short-time	> 300 A/m, 380 μ tesla
Rated insulation voltage	75 VDC	Vibration (IEC 60068-2-6)	10 to 150 Hz, 1 mm / 15 g
Dielectric test voltage	500 Vac rms (EN60947-1)	Shock (IEC 60068-2-27)	30 g / 11 ms, 6 pos, 6 neg per axis
Rated impulse withstand test	800 V (1.2 / 50 μs) (EN60947-1)	Free fall (IEC 60068-2-31)	2 times from 1 m, 100 times from 0.5 m
ESPE	Type 2	Pig-tail connector (-C2)	3-pol micro MATE-N-LOK Series, AMP/TE
PFH_d	6 x 10 ⁻⁸ failure per hour (worst case SRP for CS)	Housing material	
Diagnostic coverage	99 % (EN13849-1: 2008)	Body PE12	PC black
Performance level	C (EN13849-1: 2008)	Front glass	PC black
MTTF_d (worst case full sensor)	298 Years (worst case full receiver) EN ISO 13849-1, SN 29500 368 Years (worst case full emitter) EN ISO 13849-1, SN 29500	Connection	
Electrostatic discharge (EN61000-4-2)		Cable	PVC, Emitter: grey / Receiver: black, 5 m, 3 x 0.14 mm ² , Ø 2.9 mm
Contact discharge	> 12 kV	Weight	
Air discharge	> 8 kV	Emitter	80 g
Radiated RF electromagnetic fields (EN 61000-4-3)	> 10 V/m	Receiver	80 g
Electrical fast transients/burst (EN 61000-4-4)	± 4 kV	CE-marking	EN12445, EN12453, EN12978, EN 60947-5-2
		UL-Approval	UL325 UL508, CSA-C22.2 No.247

Operation Diagram

t_v = Power ON delay

Power supply

Target emitter present

Object present

Break (NC) Output ON

Make (NO) Output ON

Mute active ≤ 1.2 VDC

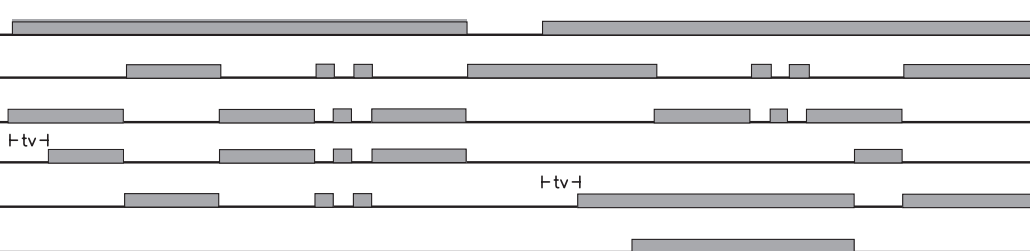

Dimensions (mm)

PE12.....

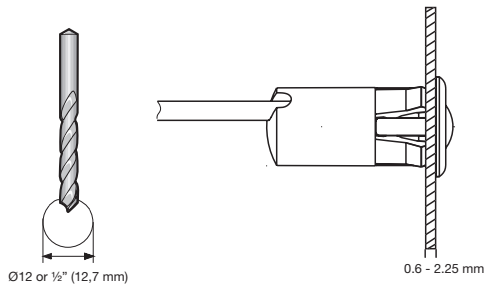
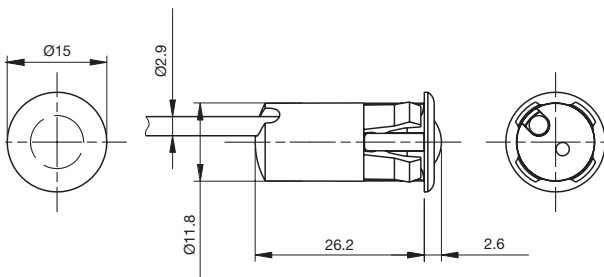

PE12.....-C2 with connector

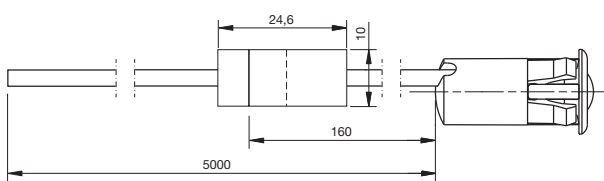

To be mounted in material with a thickness of 0.6 - 2.25 mm

Detection Diagram

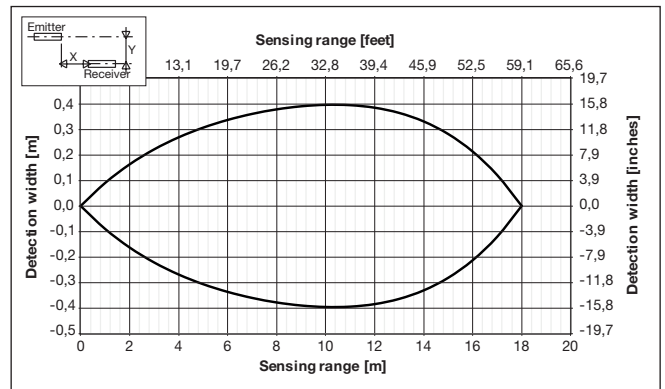

Excess Gain

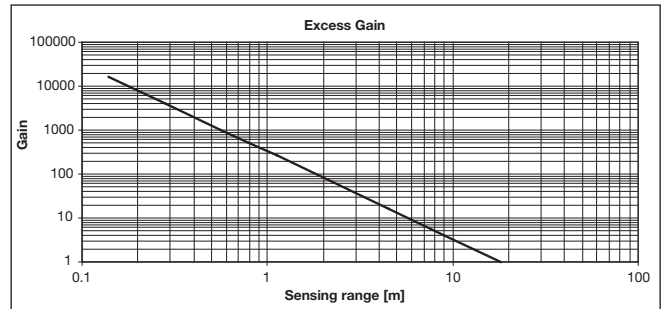

Power adjustment curve

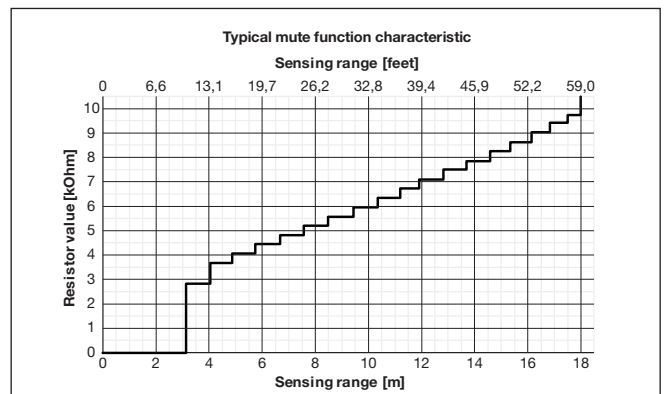

Wiring Diagram

Delivery Contents

- PE12...
- **Packaging:** plastic bag

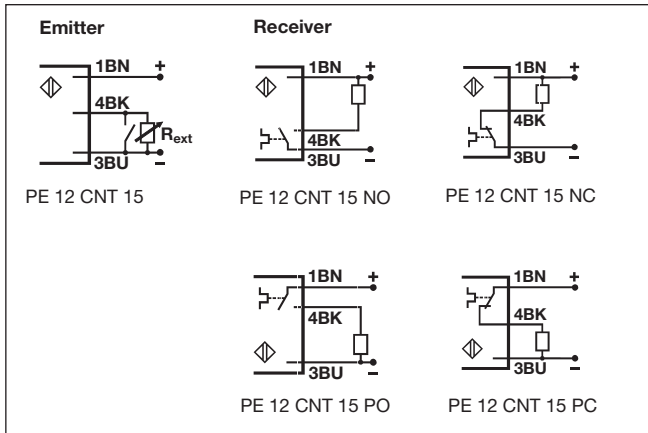

Installation Hints

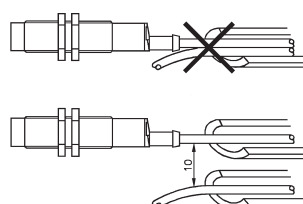
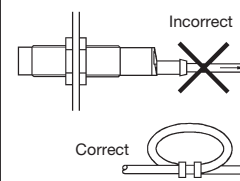
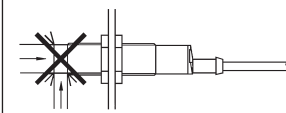
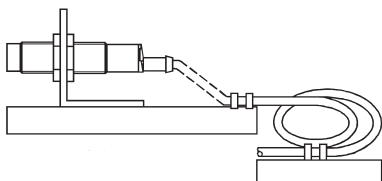
<p>To avoid interference from inductive voltage/current peaks, separate the prox. switch power cables from any other power cables, e.g. motor, contactor or solenoid cables</p> 	<p>Relief of cable strain</p>  <p>The cable should not be pulled</p>	<p>Protection of the sensing face</p>  <p>A proximity switch should not serve as mechanical stop</p>	<p>Switch mounted on mobile carrier</p>  <p>Any repetitive flexing of the cable should be avoided</p>
---	--	--	---