



Chipsmall Limited consists of a professional team with an average of over 10 year of expertise in the distribution of electronic components. Based in Hongkong, we have already established firm and mutual-benefit business relationships with customers from,Europe,America and south Asia,supplying obsolete and hard-to-find components to meet their specific needs.

With the principle of “Quality Parts,Customers Priority,Honest Operation,and Considerate Service”,our business mainly focus on the distribution of electronic components. Line cards we deal with include Microchip,ALPS,ROHM,Xilinx,Pulse,ON,Everlight and Freescale. Main products comprise IC,Modules,Potentiometer,IC Socket,Relay,Connector.Our parts cover such applications as commercial,industrial, and automotives areas.

We are looking forward to setting up business relationship with you and hope to provide you with the best service and solution. Let us make a better world for our industry!



## Contact us

Tel: +86-755-8981 8866 Fax: +86-755-8427 6832

Email & Skype: info@chipsmall.com Web: www.chipsmall.com

Address: A1208, Overseas Decoration Building, #122 Zhenhua RD., Futian, Shenzhen, China



# PE42522

## Product Specification

UltraCMOS® SPDT RF Switch, 9 kHz–26.5 GHz



### Features

- Broad frequency support from 9 kHz to 26.5 GHz
- High port to port isolation
  - 63 dB @ 3 GHz
  - 58 dB @ 7.5 GHz
  - 39 dB @ 13.5 GHz
  - 28 dB @ 20 GHz
  - 22 dB @ 26.5 GHz
- HaRP™ technology enhanced
  - Fast settling time
  - No gate and phase lag
  - No drift in insertion loss and phase
- Improved high frequency insertion loss and return loss performance with external matching
- High ESD performance of 3.5 kV HBM on all pins
- Packaging – 29-lead 4 × 4 mm LGA

Figure 1 • PE42522 Functional Diagram

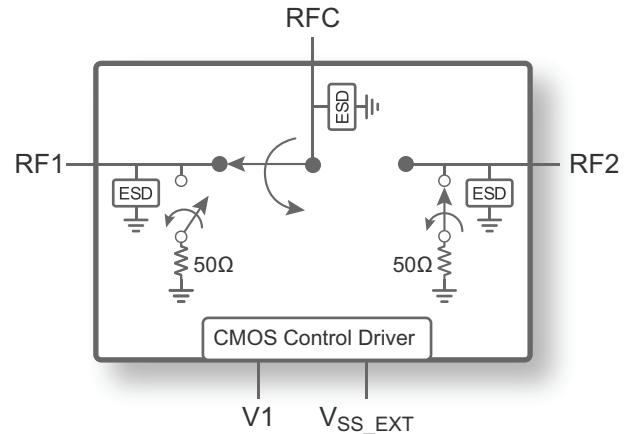

### Applications

- Test and measurement
- Microwave backhaul
- Radar

### Product Description

The PE42522 is a HaRP™ technology-enhanced absorptive SPDT RF switch that supports a broad frequency range from 9 kHz to 26.5 GHz. This broadband general purpose switch offers excellent isolation, high linearity performance and has exceptional settling time making this device ideal for many broadband wireless applications. No blocking capacitors are required if DC voltage is not present on the RF ports.

The PE42522 is manufactured on Peregrine's UltraCMOS® process, a patented variation of silicon-on-insulator (SOI) technology on a sapphire substrate.

Peregrine's HaRP technology enhancements deliver high linearity and excellent harmonics performance. It is an innovative feature of the UltraCMOS process, offering the performance of GaAs with the economy and integration of conventional CMOS.

## Optional External $V_{SS}$ Control

For proper operation, the  $V_{SS\_EXT}$  control pin must be grounded or tied to the  $V_{SS}$  voltage specified in **Table 2**. When the  $V_{SS\_EXT}$  control pin is grounded, FETs in the switch are biased with an internal negative voltage generator. For applications that require the lowest possible spur performance,  $V_{SS\_EXT}$  can be applied externally to bypass the internal negative voltage generator.

## Absolute Maximum Ratings

Exceeding absolute maximum ratings listed in **Table 1** may cause permanent damage. Operation should be restricted to the limits in **Table 2**. Operation between operating range maximum and absolute maximum for extended periods may reduce reliability.

## ESD Precautions

When handling this UltraCMOS device, observe the same precautions as with any other ESD-sensitive devices. Although this device contains circuitry to protect it from damage due to ESD, precautions should be taken to avoid exceeding the rating specified in **Table 1**.

## Latch-up Immunity

Unlike conventional CMOS devices, UltraCMOS devices are immune to latch-up.

**Table 1 • Absolute Maximum Ratings for PE42522**

Parameter/Condition	Min	Max	Unit
Supply voltage, $V_{DD}$	-0.3	5.5	V
Digital input voltage, $V_I$	-0.3	3.6	V
RF input power, CW (RFC–RFX) <sup>(1)</sup> 9 kHz–2.89 MHz >2.89 MHz–18 GHz >18–26.5 GHz		Fig. 2, Fig. 3 33 Fig. 4	dBm dBm dBm
RF input power, pulsed (RFC–RFX) <sup>(2)</sup> 9 kHz–2.89 MHz >2.89 MHz–18 GHz >18–26.5 GHz		Fig. 2, Fig. 3 34 Fig. 4	dBm dBm dBm
RF input power into terminated ports, CW (RFX) <sup>(1)</sup> 9 kHz–1.39 MHz >1.39 MHz–18 GHz >18–26.5 GHz		Fig. 2, Fig. 3 22 Fig. 4	dBm dBm dBm
Storage temperature range	-65	+150	°C
ESD voltage HBM, all pins <sup>(3)</sup>		3500	V
ESD voltage MM, all pins <sup>(4)</sup>		150	V
ESD voltage CDM, all pins <sup>(5)</sup>		500	V



**Table 1 • Absolute Maximum Ratings for PE42522 (Cont.)**

Parameter/Condition	Min	Max	Unit
<b>Notes:</b>			
1) 100% duty cycle, all bands, 50Ω.			
2) Pulsed, 5% duty cycle of 4620 μs period, 50Ω.			
3) Human body model (MIL-STD 883 Method 3015).			
4) Machine model (JEDEC JESD22-A115).			
5) Charged device model (JEDEC JESD22-C101).			

## Recommended Operating Conditions

Table 2 list the recommending operating condition for PE42522. Devices should not be operated outside the recommended operating conditions listed below.

**Table 2 • Recommended Operating Condition for PE42522**

Parameter	Min	Typ	Max	Unit
<b>Normal mode (V<sub>SS_EXT</sub> = 0V)<sup>(1)</sup></b>				
Supply voltage, V <sub>DD</sub>	2.3		5.5	V
Supply current, I <sub>DD</sub>		120	200	μA
<b>Bypass mode (V<sub>SS_EXT</sub> = -3.4V)<sup>(2)</sup></b>				
Supply voltage, V <sub>DD</sub> (V <sub>DD</sub> ≥ 3.4V for Table 3 full spec. compliance)	2.7	3.4	5.5	V
Supply current, I <sub>DD</sub>		50	80	μA
Negative supply voltage, V <sub>SS_EXT</sub>	-3.6		-3.2	V
Negative supply current, I <sub>SS</sub>	-40	-16		μA
<b>Normal or Bypass mode</b>				
Digital input high, V <sub>I</sub>	1.17		3.6	V
Digital input low, V <sub>I</sub>	-0.3		0.6	V
RF input power, CW (RFC-RFX) <sup>(3)</sup> 9 kHz–2.89 MHz >2.89 MHz–18 GHz >18–26.5 GHz			Fig. 2, Fig. 3 30 Fig. 4	dBm dBm dBm
RF input power, pulsed (RFC-RFX) <sup>(4)</sup> 9 kHz–2.89 MHz >2.89 MHz–18 GHz >18–26.5 GHz			Fig. 2, Fig. 3 32 Fig. 4	dBm dBm dBm

Table 2 • Recommended Operating Condition for PE42522 (Cont.)

Parameter	Min	Typ	Max	Unit
RF input power into terminated ports, CW (RFX) <sup>(3)</sup> 9 kHz–1.39 MHz >1.39 MHz–18 GHz >18–26.5 GHz			Fig. 2, Fig. 3 20 Fig. 4	dBm dBm dBm
Operating temperature range, T <sub>OP</sub>	–40	+25	+85	°C
<b>Notes:</b> 1) Normal mode: connect V <sub>SS_EXT</sub> (pin 29) to GND (V <sub>SS_EXT</sub> = 0V) to enable internal negative voltage generator. 2) Bypass mode: use V <sub>SS_EXT</sub> (pin 29) to bypass and disable internal negative voltage generator. 3) 100% duty cycle, all bands, 50Ω. 4) Pulsed, 5% duty cycle of 4620 μs period, 50Ω.				

## Electrical Specifications

Table 3 provides the PE42522 key electrical specifications at 25 °C (Z<sub>S</sub> = Z<sub>L</sub> = 50Ω), unless otherwise specified. Normal mode<sup>(1)</sup> is at V<sub>DD</sub> = 3.3V and V<sub>SS\_EXT</sub> = 0V. Bypass mode<sup>(2)</sup> is at V<sub>DD</sub> = 3.4V and V<sub>SS\_EXT</sub> = –3.4V.

Table 3 • PE42522 Electrical Specifications

Parameter	Path	Condition	Min	Typ	Max	Unit
Operating frequency			9 kHz		26.5 GHz	As shown
Insertion loss <sup>(3)</sup>	RFC–RFX	9 kHz–10 MHz		0.70	0.85	dB
		10–3000 MHz		1.05	1.40	dB
		3000–7500 MHz		1.15	1.50	dB
		7500–10000 MHz		1.70	2.15	dB
		10000–13500 MHz		1.70	2.40	dB
		13500–18000 MHz		2.55	3.25	dB
		18000–20000 MHz		3.15	4.40	dB
20000–24000 MHz		4.20	5.45	dB		
24000–26500 MHz		5.30	6.95	dB		

**Table 3 • PE42522 Electrical Specifications (Cont.)**

Parameter	Path	Condition	Min	Typ	Max	Unit
Isolation	RFX–RFX	9 kHz–10 MHz	70	80		dB
		10–3000 MHz	62	64		dB
		3000–7500 MHz	48	50		dB
		7500–10000 MHz	42	44		dB
		10000–13500 MHz	36	38		dB
		13500–18000 MHz	26	28		dB
		18000–20000 MHz	23	25		dB
		20000–24000 MHz	19	21		dB
	24000–26500 MHz	18	20		dB	
	RFC–RFX	9 kHz–10 MHz	65	73		dB
		10–3000 MHz	61	63		dB
		3000–7500 MHz	55	58		dB
		7500–10000 MHz	48	51		dB
		10000–13500 MHz	37	39		dB
		13500–18000 MHz	28	30		dB
		18000–20000 MHz	26	28		dB
20000–24000 MHz		21	23		dB	
24000–26500 MHz	19	22		dB		
Return loss (active port) <sup>(3)</sup>	RFC–RFX	9 kHz–10 MHz		23		dB
		10–3000 MHz		18		dB
		3000–7500 MHz		16		dB
		7500–10000 MHz		15		dB
		10000–13500 MHz		20		dB
		13500–18000 MHz		13		dB
		18000–20000 MHz		7		dB
		20000–24000 MHz		5		dB
24000–26500 MHz		6		dB		
Return loss (RFC port) <sup>(3)</sup>	RFC–RFX	9 kHz–10 MHz		23		dB
		10–3000 MHz		19		dB
		3000–7500 MHz		27		dB
		7500–10000 MHz		27		dB
		10000–13500 MHz		20		dB
		13500–18000 MHz		23		dB
		18000–20000 MHz		10		dB
		20000–24000 MHz		6		dB
24000–26500 MHz		7		dB		
Return loss (off port)	All ports	9 kHz–10 MHz		30		dB
		10–3000 MHz		23		dB
		3000–7500 MHz		15		dB
		7500–10000 MHz		13		dB
		10000–13500 MHz		14		dB
		13500–18000 MHz		8		dB
		18000–20000 MHz		6		dB
		20000–24000 MHz		3		dB
24000–26500 MHz		2		dB		

Table 3 • PE42522 Electrical Specifications (Cont.)

Parameter	Path	Condition	Min	Typ	Max	Unit
Input 0.1dB compression point <sup>(4)</sup>	RFC–RFX			Fig. 2 Fig. 3 Fig. 4		dBm dBm dBm
Input IP2	RFC–RFX	10–18000 MHz		121		dBm
Input IP3	RFC–RFX	10–18000 MHz		59		dBm
Settling time		50% CTRL to 0.05 dB final value		7	10	µs
Switching time		50% CTRL to 90% or 10% of RF		3	4.5	µs

**Notes:**

- 1) Normal mode: connect V<sub>SS\_EXT</sub> (pin 29) to GND (V<sub>SS\_EXT</sub> = 0V) to enable internal negative voltage generator.
- 2) Bypass mode: use V<sub>SS\_EXT</sub> (pin 29) to bypass and disable internal negative voltage generator.
- 3) High frequency performance can be improved by external matching (see Figure 19–Figure 21).
- 4) The input 0.1dB compression point is a linearity figure of merit. Refer to Table 2 for the RF input power (50Ω).

## Switching Frequency

The PE42522 has a maximum 25 kHz switching rate in normal mode (pin 29 tied to ground). A faster switching rate is available in bypass mode (pin 29 tied to V<sub>SS\_EXT</sub>). The rate at which the PE42522 can be switched is then limited to the switching time as specified in Table 3.

Switching frequency describes the time duration between switching events. Switching time is the time duration between the point the control signal reached 50% of the final value and the point the output signal reaches within 10% or 90% of its target value.

## Spur-Free Performance

The typical spurious performance of the PE42522 in normal mode is –125 dBm (pin 29 tied to ground). If spur-free performance is desired, the internal negative voltage generator can be disabled by applying a negative voltage to V<sub>SS\_EXT</sub> (pin 29).

## Hot-Switching Capability

The maximum hot switching capability of the PE42522 is 20 dBm from 1.4 MHz to 18 GHz. The maximum hot switching capability below 1.4 MHz and above 18 GHz does not exceed the maximum RF CW terminated power, see Figure 2–Figure 4. Hot switching occurs when RF power is applied while switching between RF ports.

## Control Logic

Table 4 provides the control logic truth table for PE42522.

Table 4 • Truth Table for PE42522

State	V1
RF1 ON	0
RF2 ON	1

Figure 2 • Power De-rating Curve (9 kHz–18 GHz) @ 25 °C Ambient (50Ω)

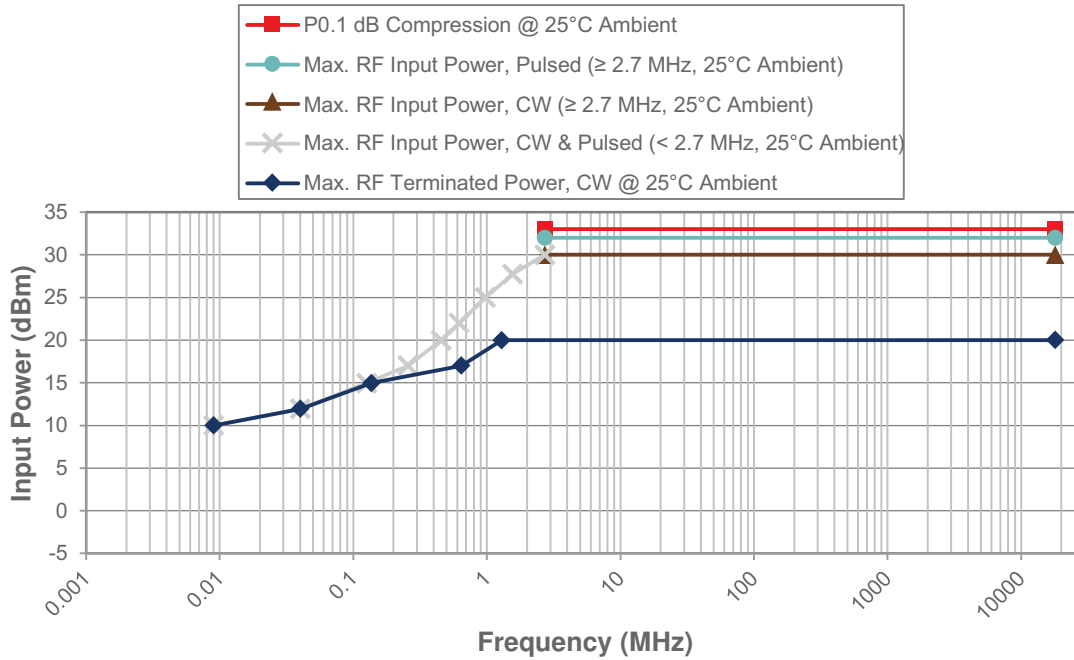

Figure 3 • Power De-rating Curve (9 kHz–18 GHz) @ 85 °C Ambient (50Ω)

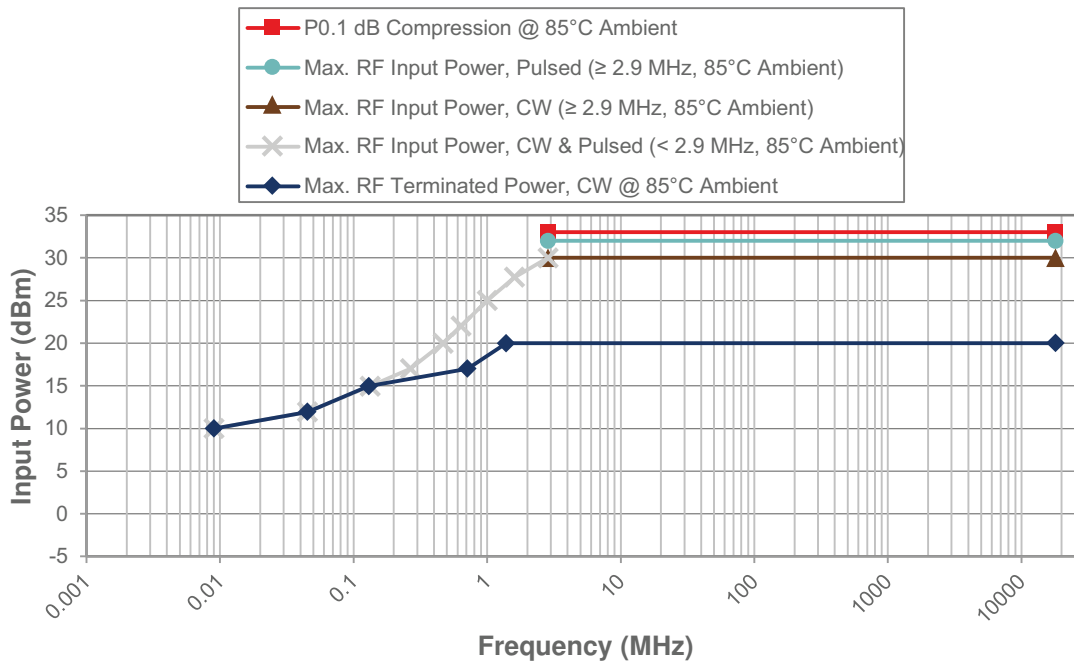
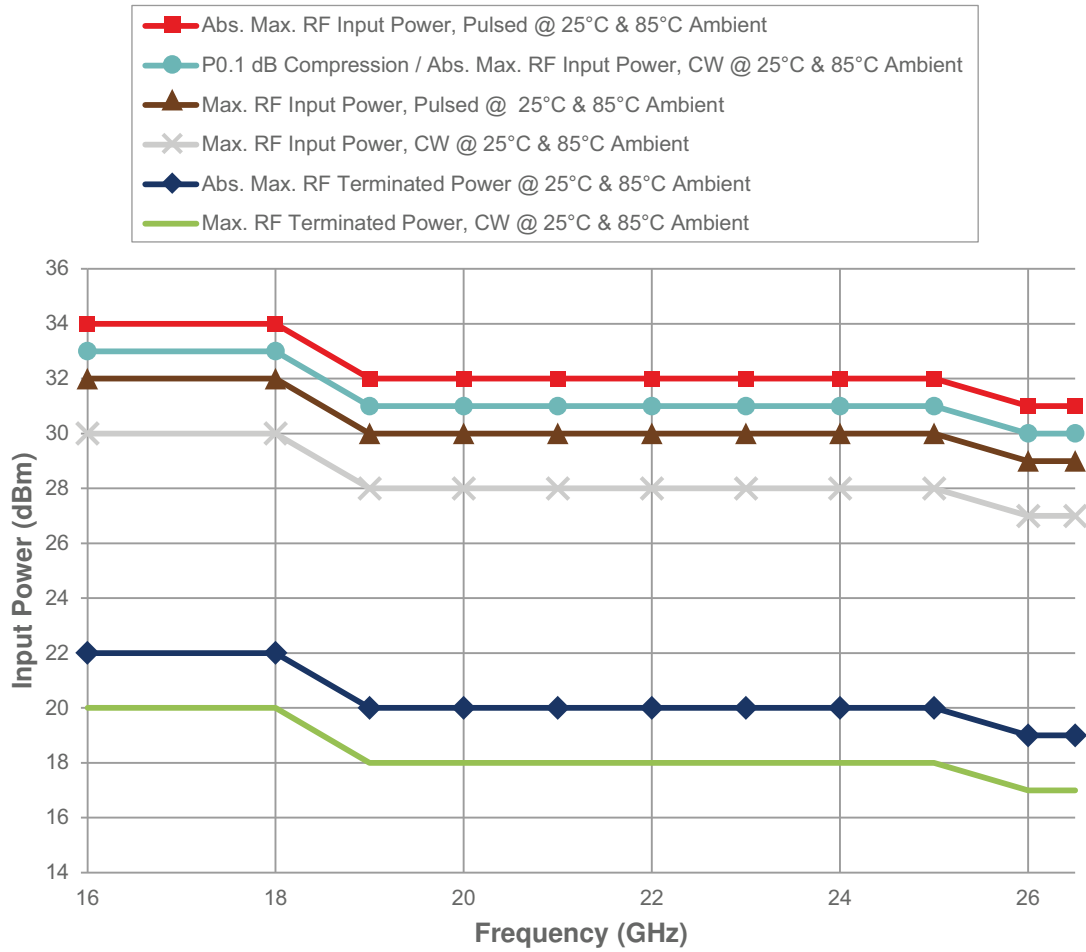



Figure 4 • Power De-rating Curve (16–26.5 GHz) @ 25 °C and 85 °C Ambient (50Ω)



## Typical Performance Data

Figure 5–Figure 17 show the typical performance data at 25 °C and  $V_{DD} = 3.3V$  ( $Z_S = Z_L = 50\Omega$ ) unless otherwise specified.

Figure 5 • Insertion Loss (RFC–RFX)<sup>(\*)</sup>

Note: \* High frequency performance can be improved by external matching (see Figure 19–Figure 21).

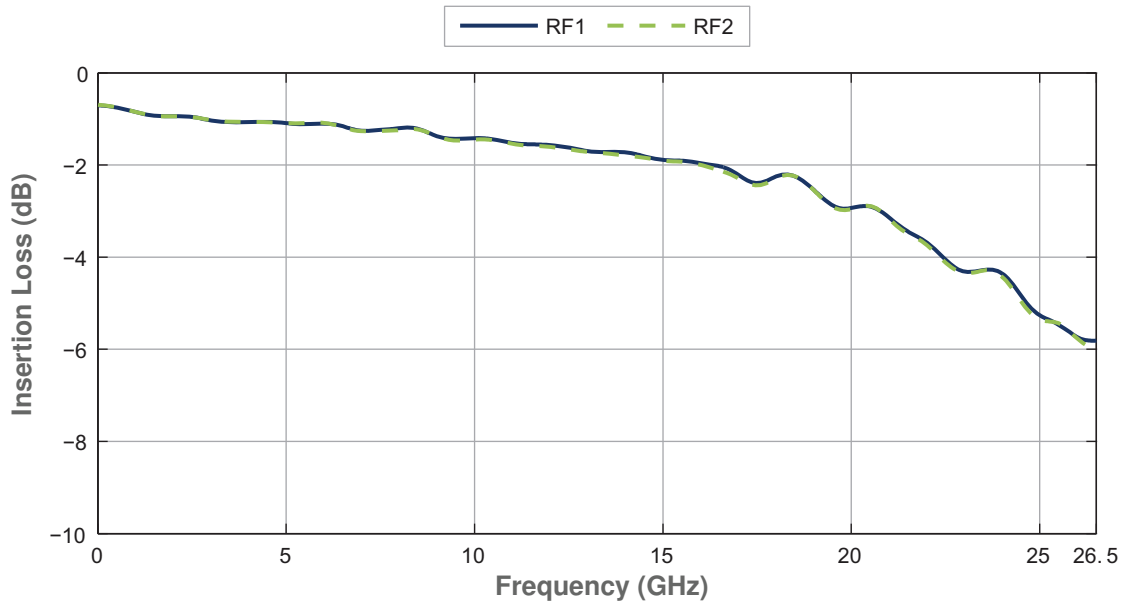

Figure 6 • Insertion Loss vs Temperature (RFC–RFX)<sup>(\*)</sup>

Note: \* High frequency performance can be improved by external matching (see Figure 19–Figure 21).

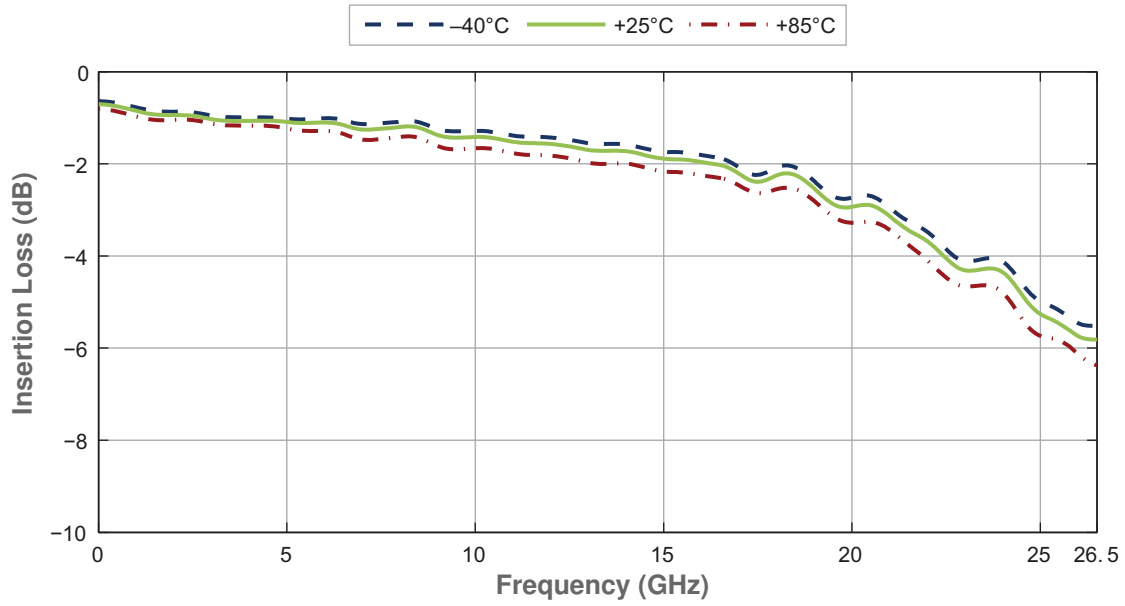
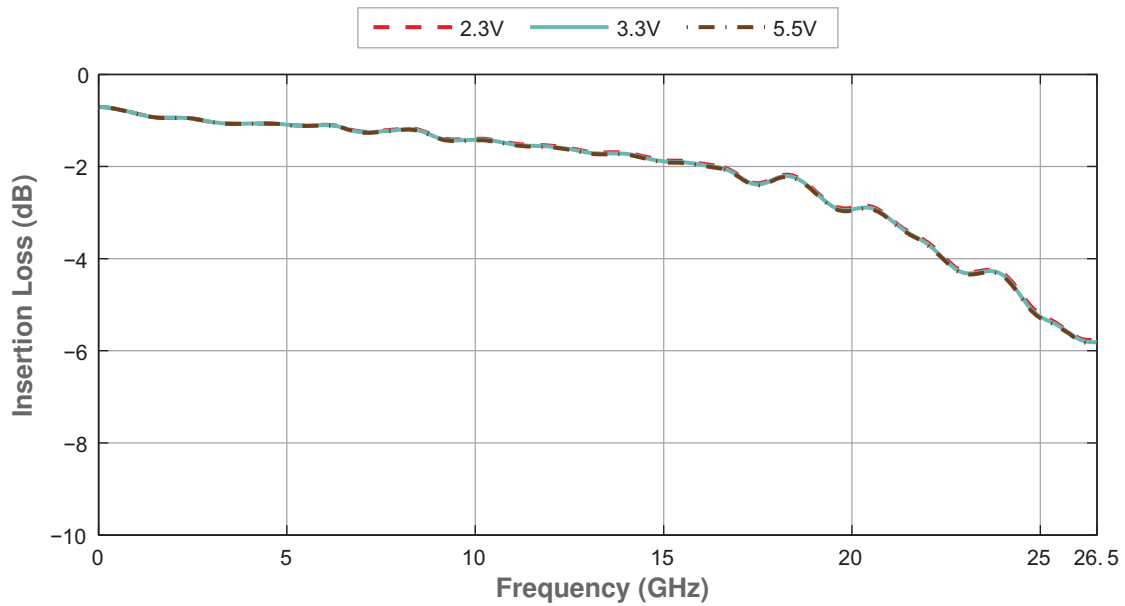

Figure 7 • Insertion Loss vs  $V_{DD}$  (RFC–RFX)<sup>(\*)</sup>

Note: \* High frequency performance can be improved by external matching (see Figure 19–Figure 21).



**Figure 8 • RFC Port Return Loss vs Temperature<sup>(\*)</sup>**

Note: \* High frequency performance can be improved by external matching (see Figure 19–Figure 21).

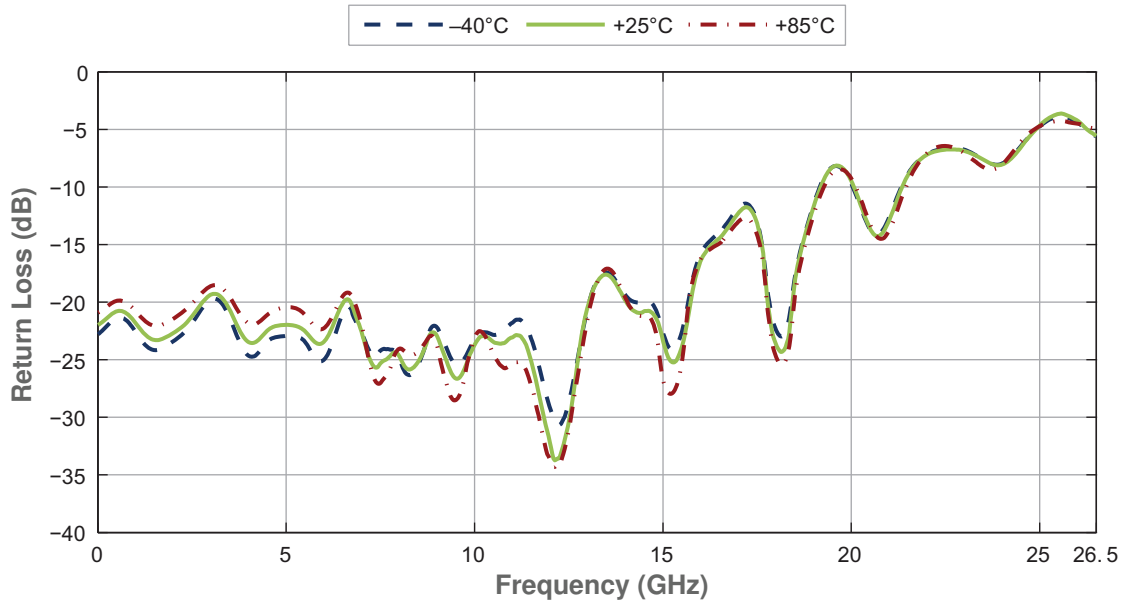

**Figure 9 • RFC Port Return Loss vs  $V_{DD}$ <sup>(\*)</sup>**

Note: \* High frequency performance can be improved by external matching (see Figure 19–Figure 21).

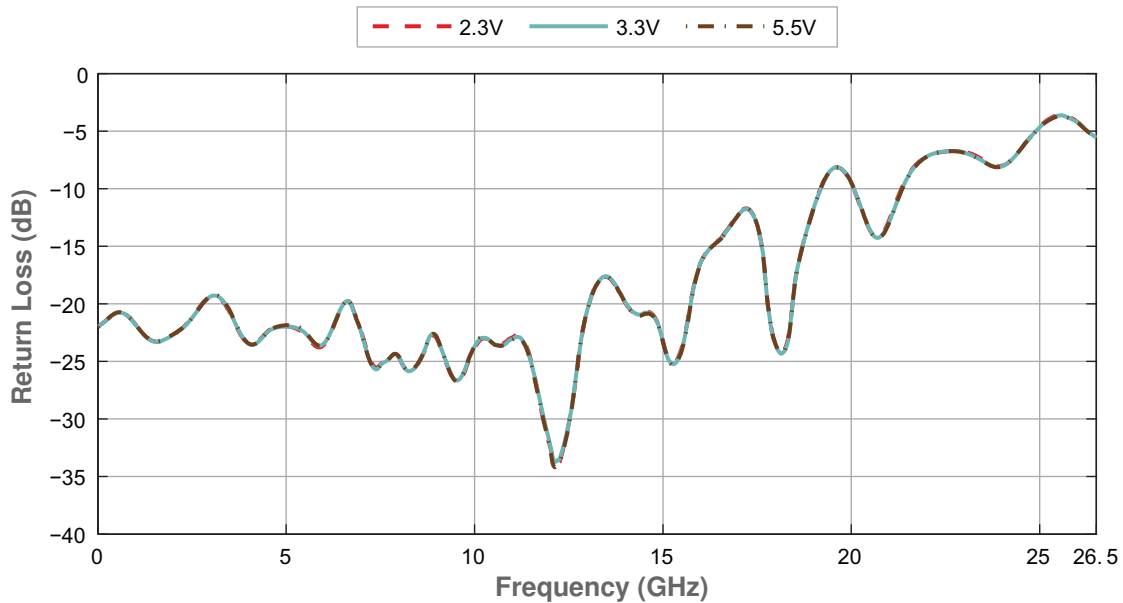

Figure 10 • Active Port Return Loss vs Temperature<sup>(\*)</sup>

Note: \* High frequency performance can be improved by external matching (see Figure 19–Figure 21).

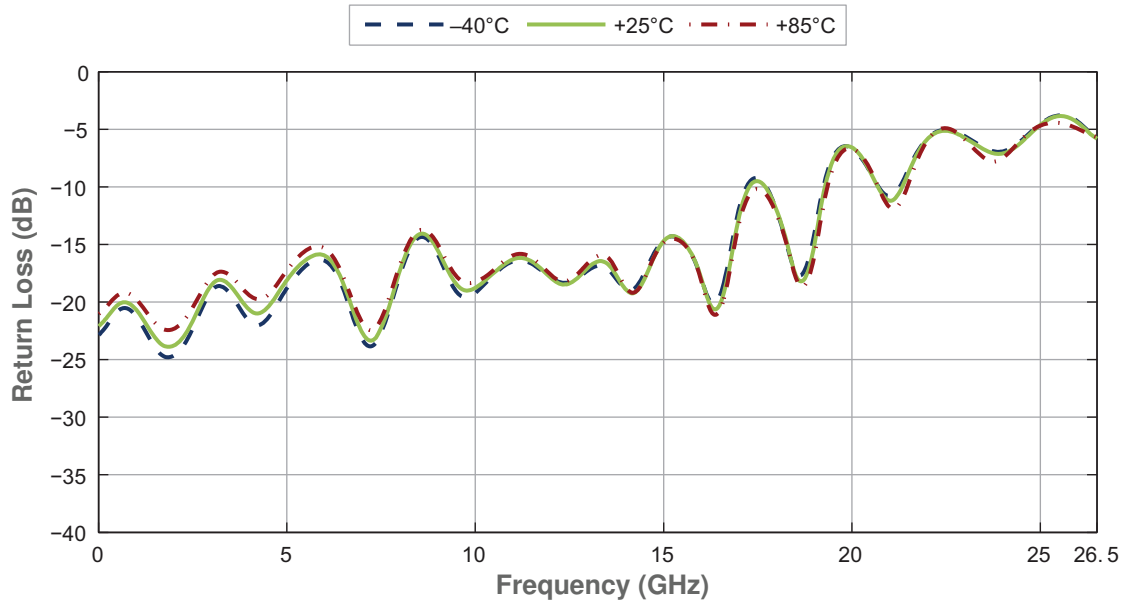

Figure 11 • Active Port Return Loss vs  $V_{DD}$ <sup>(\*)</sup>

Note: \* High frequency performance can be improved by external matching (see Figure 19–Figure 21).

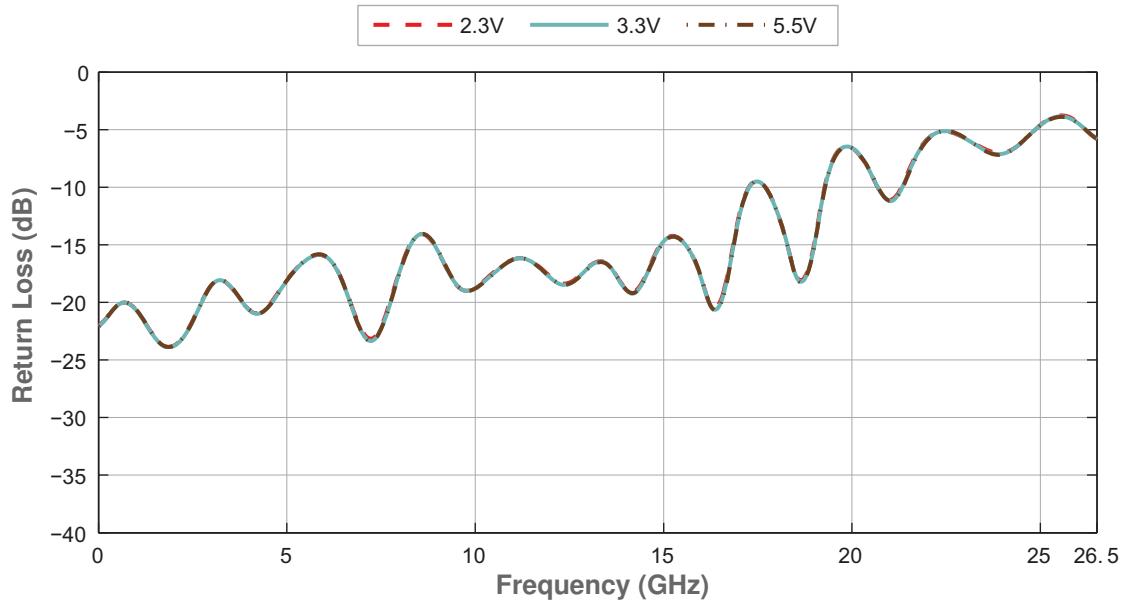



Figure 12 • Terminated Port Return Loss vs Temperature

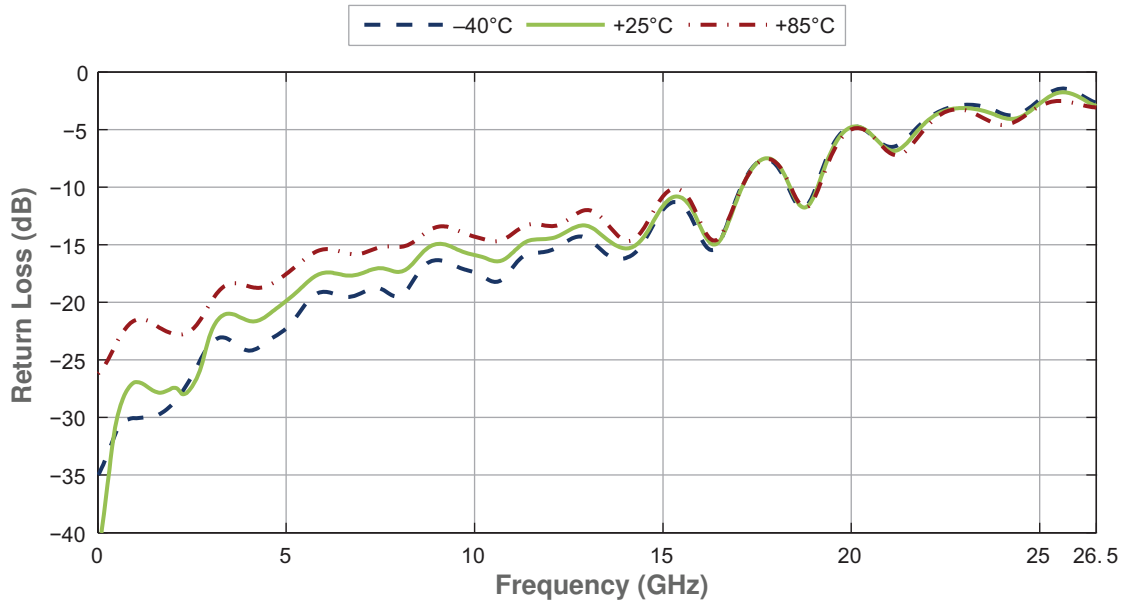

Figure 13 • Terminated Port Return Loss vs  $V_{DD}$

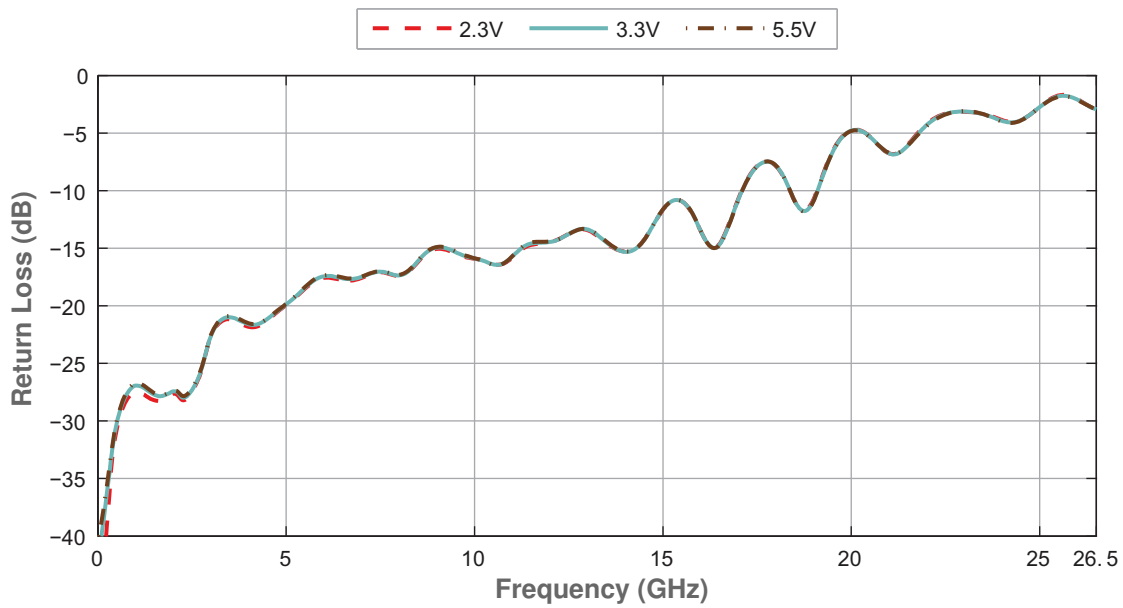

Figure 14 • Isolation vs Temperature (RFX–RFX)

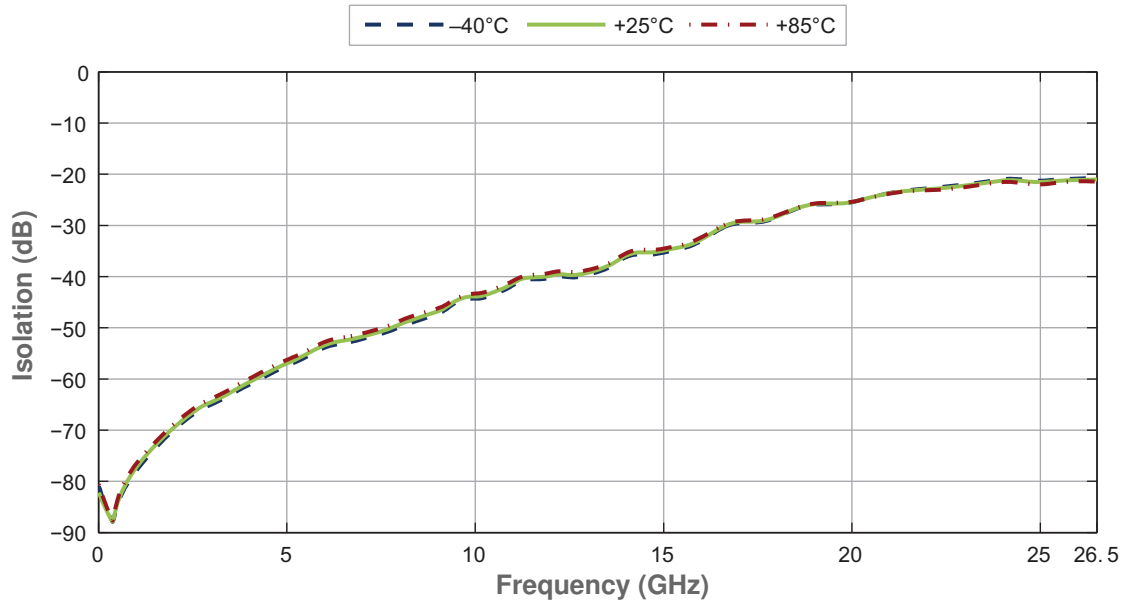

Figure 15 • Isolation vs  $V_{DD}$  (RFX–RFX)

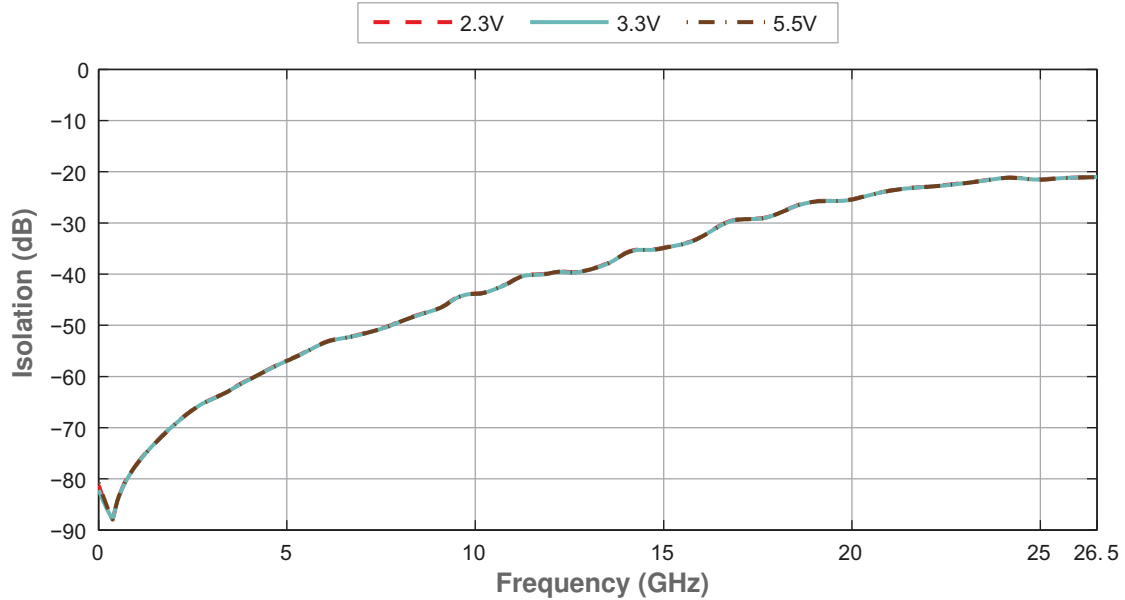

Figure 16 • Isolation vs Temperature (RFC–RFX)

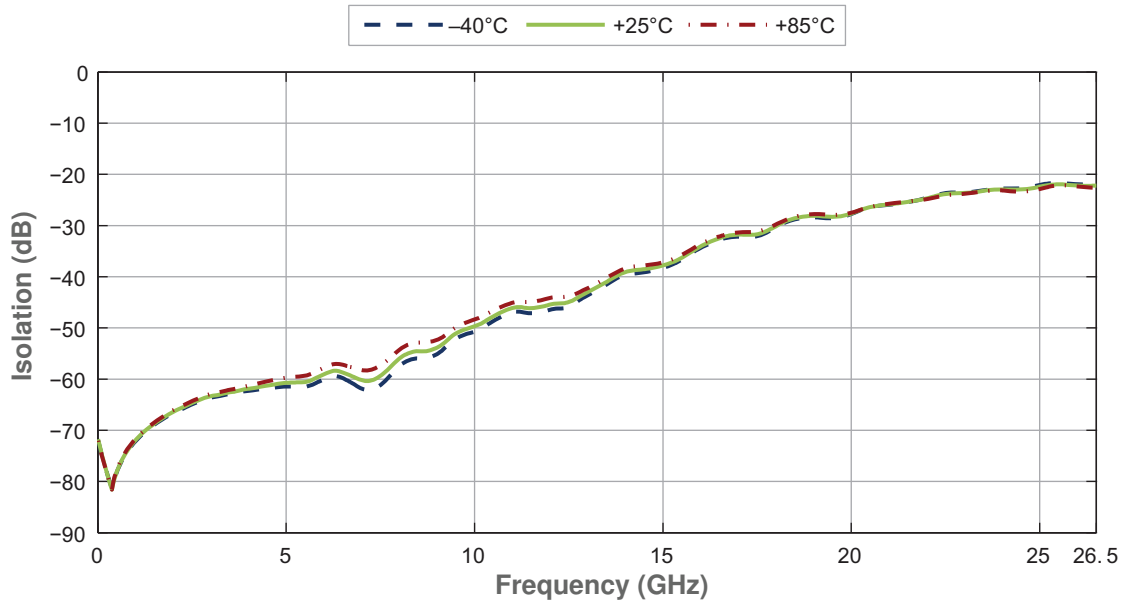
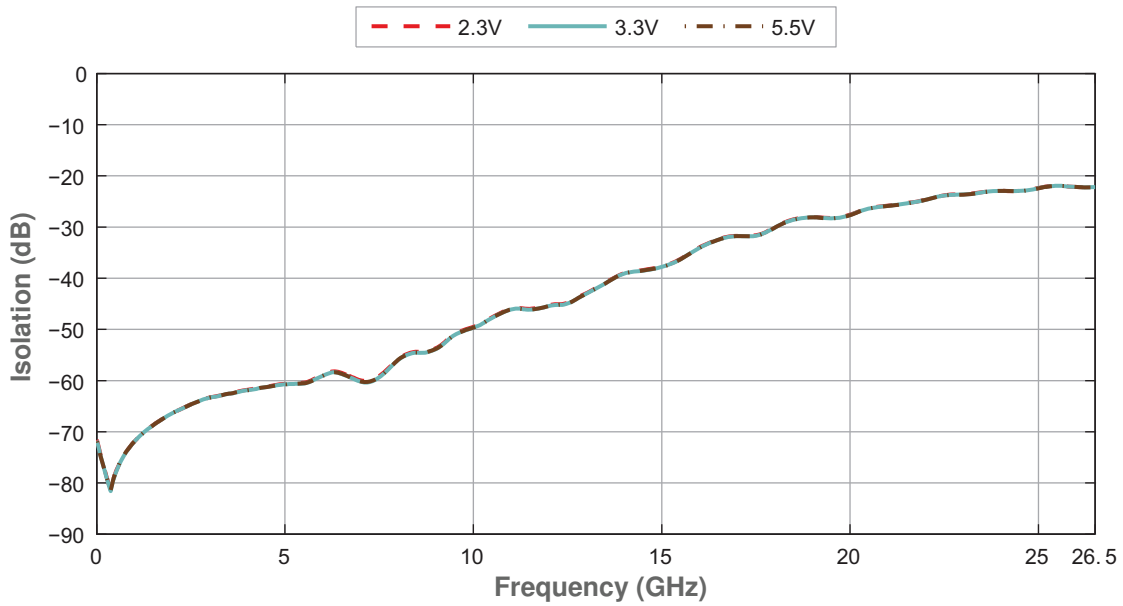

Figure 17 • Isolation vs  $V_{DD}$  (RFC–RFX)



## High Frequency Performance with External Matching

High frequency insertion loss and return loss can be further improved by external tuning traces in the customer application board layout. **Figure 18** is a sample matching network using ideal elements. **Figure 19–Figure 21** show the simulated insertion loss and return loss improvement using the matching network.

**Figure 18 • PE42522 Matching Network**

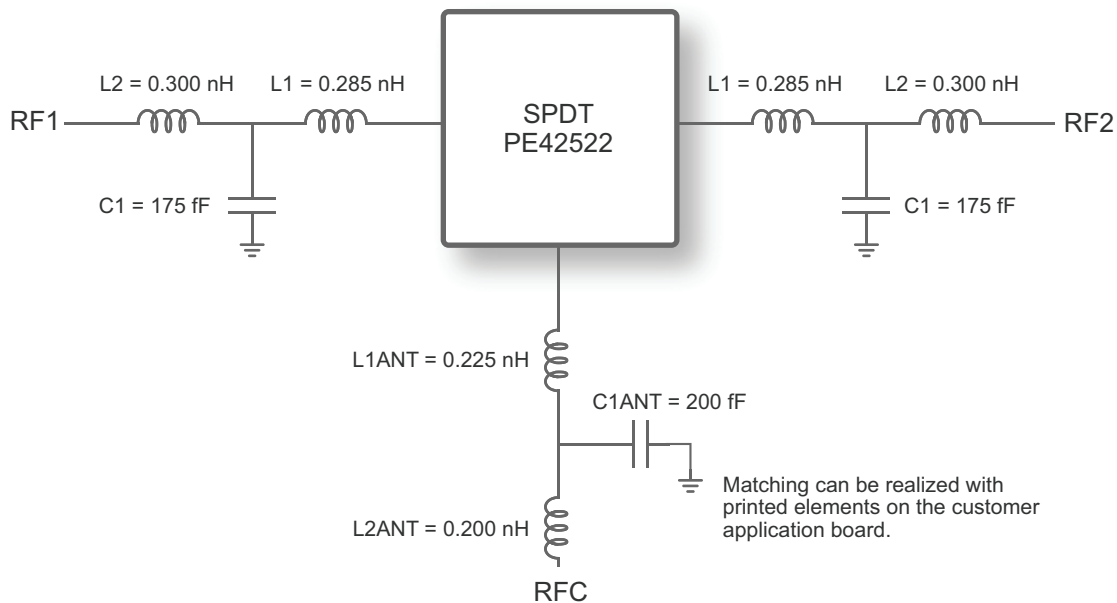

Additional information on high frequency performance with external matching can be found in Application Note 41, *PE42522/523–High Frequency Performance Improvement Through Narrowband Matching*.

**Figure 19 • Insertion Loss (RFC–RFX) With or Without Matching<sup>(\*)</sup>**

Note: \* For reference only.

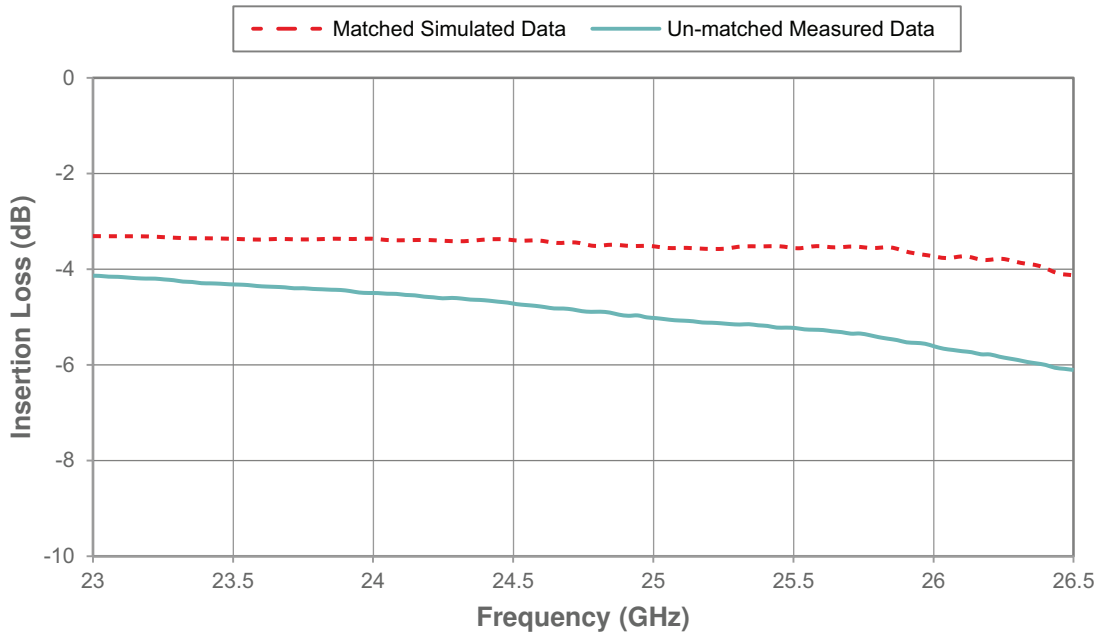

**Figure 20 • Active Port Return Loss With or Without Matching<sup>(\*)</sup>**

Note: \* For reference only.

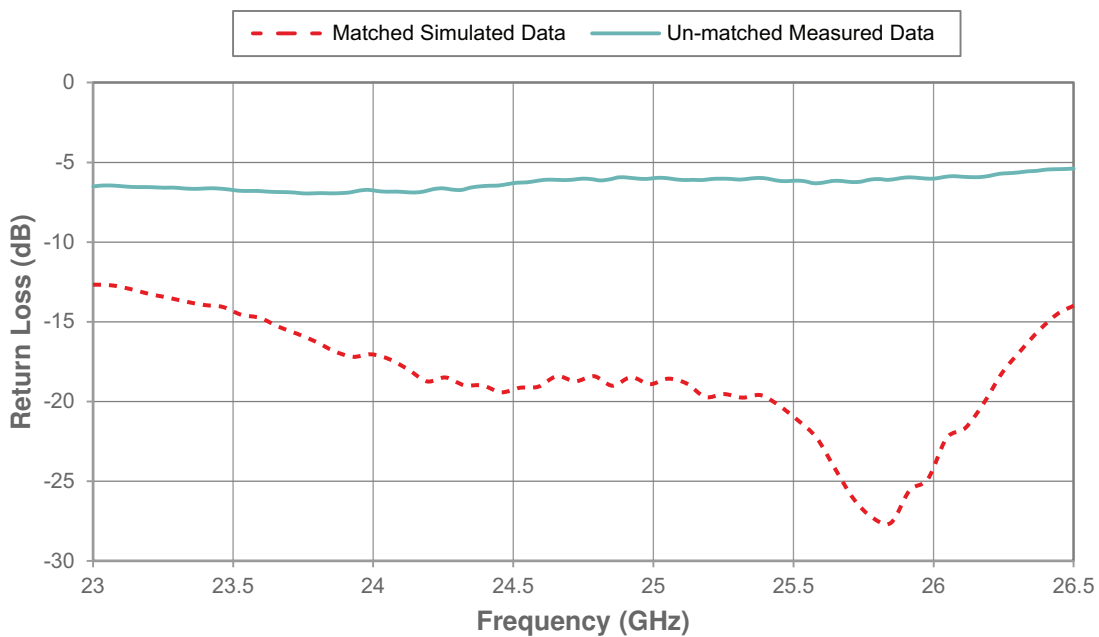
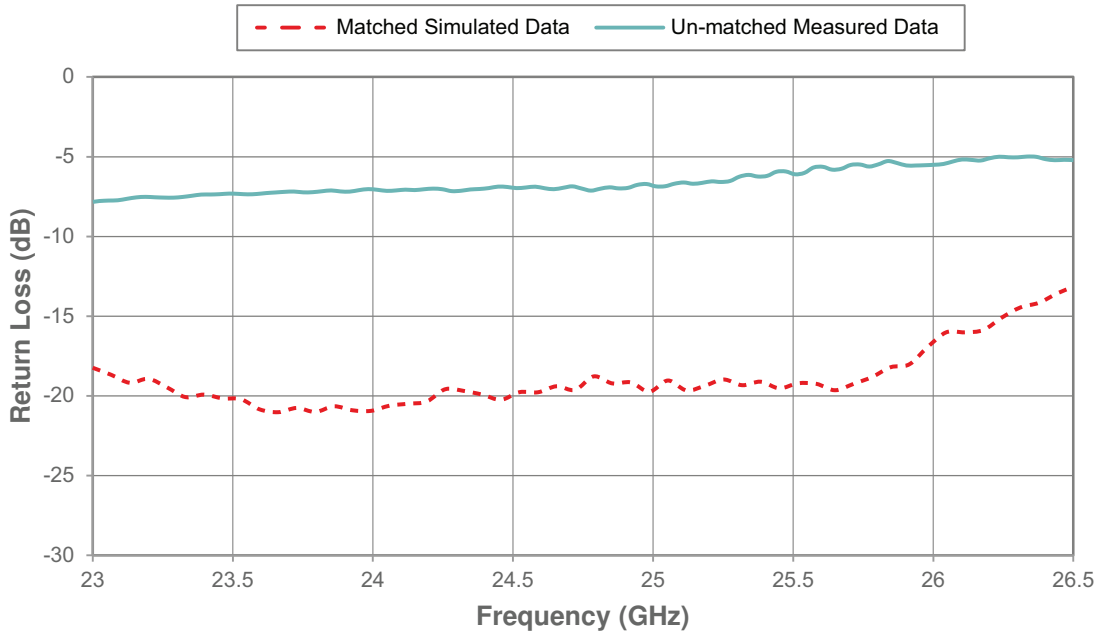



Figure 21 • RFC Port Return Loss With or Without Matching<sup>(\*)</sup>

Note: \* For reference only.



## Evaluation Kit

The SPDT switch evaluation board was designed to ease customer evaluation of Peregrine's PE42522. The RF common port is connected through a 50Ω transmission line via the SMA connector, J1. RF1 and RF2 ports are connected through 50Ω transmission lines via SMA connectors J4 and J3 respectively. A 50Ω through transmission line is available via SMA connectors J6 and J7, which can be used to de-embed the loss of the PCB. J13 provides DC and digital inputs to the device.

The board is constructed of a two metal layer material with a total thickness of 38 mils. The top RF layer is Rogers 4360 material with a thickness of 32 mils and the  $\epsilon_r = 6.4$ . The bottom layer provides ground for the transmission lines. The transmission lines were designed using a coplanar waveguide with ground plane model using a trace width of 18 mils, trace gaps of 7 mils and metal thickness of 2.1 mils.

For the true performance of the PE42522 to be realized, the PCB must be designed in such a way that RF transmission lines and sensitive DC I/O traces are well isolated from one another. High frequency insertion loss and return loss can be further improved by external tuning traces in the customer application board layout. For further details, see “**High Frequency Performance with External Matching**”.

Please note that this is a generic PCB and is being used for multiple parts. Pin labeled V2 is GND.

Figure 22 • Evaluation Kit Layout for PE42522

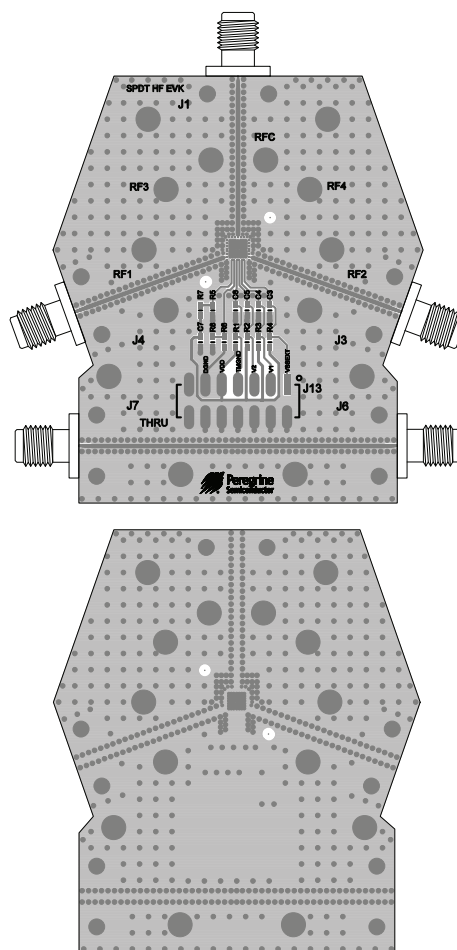

## Pin Information

This section provides pinout information for the PE42522. **Figure 23** shows the pin map of this device for the available package. **Table 5** provides a description for each pin.

**Figure 23 • Pin Configuration (Top View)**

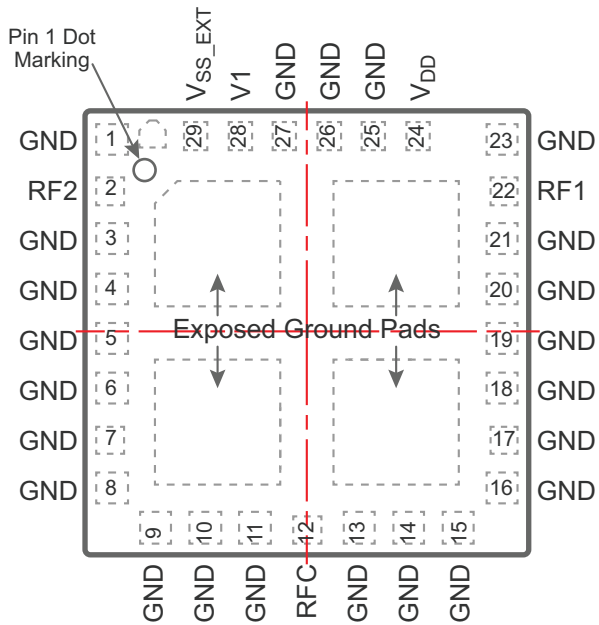

**Table 5 • Pin Descriptions for PE42522**

Pin No.	Pin Name	Description
1, 3–11, 13–21, 23, 25–27	GND	Ground
2	RF2 <sup>(1)</sup>	RF port 2
12	RFC <sup>(1)</sup>	RF common
22	RF1 <sup>(1)</sup>	RF port 1
24	V <sub>DD</sub>	Supply voltage (nominal 3.3V)
28	V1	Digital control logic input 1
29	V <sub>SS_EXT</sub> <sup>(2)</sup>	External V <sub>SS</sub> negative voltage control
Pad	GND	Exposed pad: ground for proper operation

**Notes:**

- 1) RF pins 2, 12 and 22 must be at 0 VDC. The RF pins do not require DC blocking capacitors for proper operation if the 0 VDC requirement is met.
- 2) Use V<sub>SS\_EXT</sub> (pin 29) to bypass and disable internal negative voltage generator. Connect V<sub>SS\_EXT</sub> (pin 29) to GND (V<sub>SS\_EXT</sub> = 0V) to enable internal negative voltage generator.

## Packaging Information

This section provides packaging data including the moisture sensitivity level, package drawing, package marking and tape-and-reel information.

### Moisture Sensitivity Level

The moisture sensitivity level rating for the PE42522 in the 29-lead 4 × 4 mm LGA package is MSL3.

## Package Drawing

Figure 24 • Package Mechanical Drawing for 29-lead 4 × 4 × 0.91 mm LGA

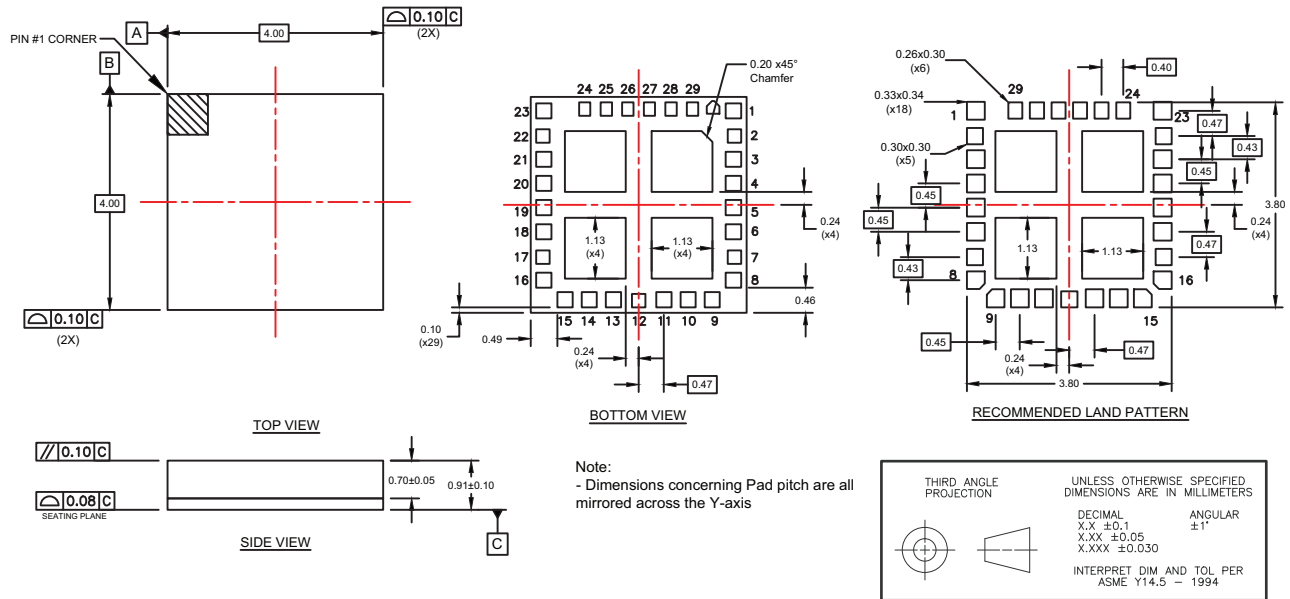

Pin Number	Pin Size (x,y)	X Coordinate	Y Coordinate
1	(0.285x0.280)	1.7575	1.7434
2	(0.250x0.250)	1.7750	1.2750
3	(0.285x0.280)	1.7575	0.8466
4	(0.285x0.280)	1.7575	0.3982
5	(0.285x0.280)	1.7575	-0.0502
6	(0.285x0.280)	1.7575	-0.4986
7	(0.250x0.250)	1.7750	-0.9670
8	(0.285x0.280)	1.7575	-1.3954
9	(0.280x0.285)	1.3652	-1.7575
10	(0.280x0.285)	0.9168	-1.7575
11	(0.280x0.285)	0.4684	-1.7575
12	(0.250x0.250)	0	-1.7750
13	(0.280x0.285)	-0.4684	-1.7575
14	(0.280x0.285)	-0.9168	-1.7575
15	(0.280x0.285)	-1.3652	-1.7575
16	(0.285x0.280)	-1.7575	-1.3954
17	(0.250x0.250)	-1.7750	-0.9670
18	(0.285x0.280)	-1.7575	-0.4986
19	(0.285x0.280)	-1.7575	-0.0502
20	(0.285x0.280)	-1.7575	0.3982
21	(0.285x0.280)	-1.7575	0.8466
22	(0.250x0.250)	-1.7750	1.2750
23	(0.285x0.280)	-1.7575	1.7434
24	(0.210x0.250)	-1	1.7750
25	(0.210x0.250)	-0.600	1.7750
26	(0.210x0.250)	-0.200	1.7750
27	(0.210x0.250)	0.200	1.7750
28	(0.210x0.250)	0.600	1.7750
29	(0.210x0.250)	1	1.7750



Figure 25 • Package Marking Specifications for PE42522

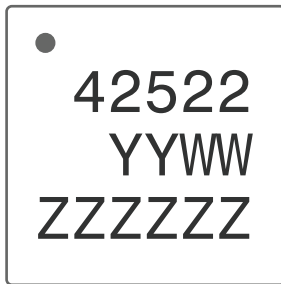

- = Pin 1 indicator
- YY = Last two digits of assembly year
- WW = Assembly work week
- ZZZZZZ = Assembly lot code (maximum six characters)

### Tape and Reel Specification

Figure 26 • Tape and Reel Specifications for 29-lead 4 × 4 × 0.91 mm LGA

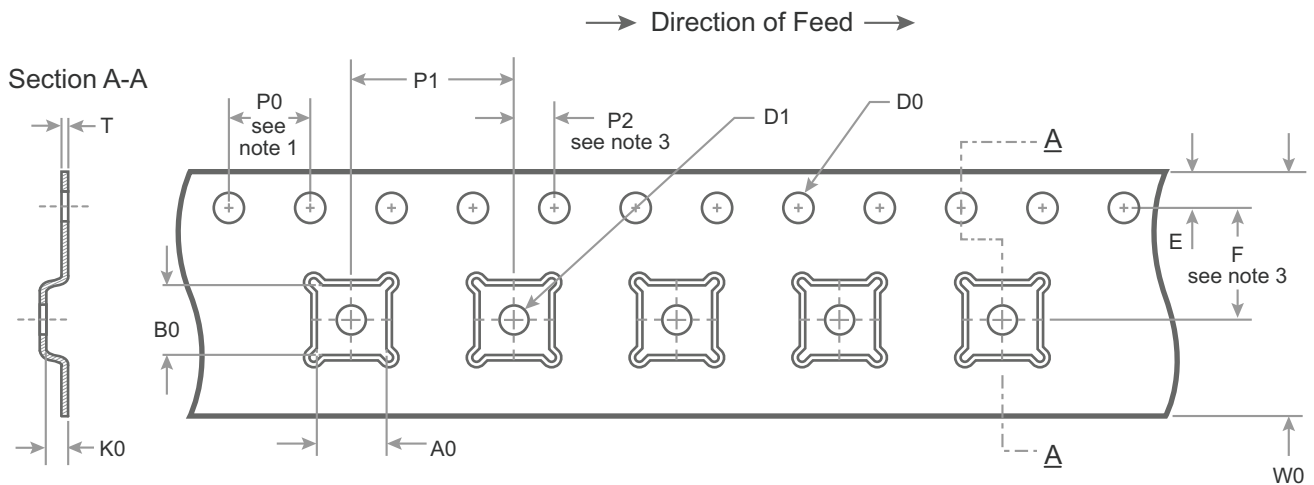

A0	4.35
B0	4.35
K0	1.10
D0	1.50 + 0.10/ -0.00
D1	1.50 min
E	1.75 ± 0.10
F	5.50 ± 0.05
P0	4.00
P1	8.00
P2	2.00 ± 0.05
T	0.30 ± 0.05
W0	12.00 ± 0.30

**Notes:**

1. 10 Sprocket hole pitch cumulative tolerance ±0.2
2. Camber in compliance with EIA 481
3. Pocket position relative to sprocket hole measured as true position of pocket, not pocket hole

Dimensions are in millimeters unless otherwise specified

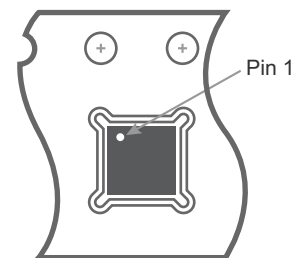

Device Orientation in Tape

## Ordering Information

Table 6 lists the available ordering codes for the PE42522 as well as available shipping methods.

Table 6 • Order Codes for PE42522

Order Codes	Description	Packaging	Shipping Method
PE42522A-X	PE42522 SPDT RF switch	29-lead 4 × 4 mm LGA	500 units / T&R
EK42522-02	PE42522 Evaluation kit	Evaluation kit	1 / box

## Document Categories

### Advance Information

The product is in a formative or design stage. The datasheet contains design target specifications for product development. Specifications and features may change in any manner without notice.

### Preliminary Specification

The datasheet contains preliminary data. Additional data may be added at a later date. Peregrine reserves the right to change specifications at any time without notice in order to supply the best possible product.

### Product Specification

The datasheet contains final data. In the event Peregrine decides to change the specifications, Peregrine will notify customers of the intended changes by issuing a CNF (Customer Notification Form).

## Sales Contact

For additional information, contact Sales at [sales@psemi.com](mailto:sales@psemi.com).

## Disclaimers

The information in this datasheet is believed to be reliable. However, Peregrine assumes no liability for the use of this information. Use shall be entirely at the user's own risk. No patent rights or licenses to any circuits described in this datasheet are implied or granted to any third party. Peregrine's products are not designed or intended for use in devices or systems intended for surgical implant, or in other applications intended to support or sustain life, or in any application in which the failure of the Peregrine product could create a situation in which personal injury or death might occur. Peregrine assumes no liability for damages, including consequential or incidental damages, arising out of the use of its products in such applications.

## Patent Statement

Peregrine products are protected under one or more of the following U.S. patents: [patents.psemi.com](http://patents.psemi.com)

## Copyright and Trademark

©2014-2015, Peregrine Semiconductor Corporation. All rights reserved. The Peregrine name, logo, UTSi and UltraCMOS are registered trademarks and HaRP, MultiSwitch and DuNE are trademarks of Peregrine Semiconductor Corp.

