



Chipsmall Limited consists of a professional team with an average of over 10 year of expertise in the distribution of electronic components. Based in Hongkong, we have already established firm and mutual-benefit business relationships with customers from,Europe,America and south Asia,supplying obsolete and hard-to-find components to meet their specific needs.

With the principle of "Quality Parts,Customers Priority,Honest Operation,and Considerate Service",our business mainly focus on the distribution of electronic components. Line cards we deal with include Microchip,ALPS,ROHM,Xilinx,Pulse,ON,Everlight and Freescale. Main products comprise IC,Modules,Potentiometer,IC Socket,Relay,Connector.Our parts cover such applications as commercial,industrial, and automotives areas.

We are looking forward to setting up business relationship with you and hope to provide you with the best service and solution. Let us make a better world for our industry!



Contact us

Tel: +86-755-8981 8866 Fax: +86-755-8427 6832

Email & Skype: info@chipsmall.com Web: www.chipsmall.com

Address: A1208, Overseas Decoration Building, #122 Zhenhua RD., Futian, Shenzhen, China



SPDT UltraCMOS™ RF Switch
9 kHz - 13500 MHz

Features

- HaRP™-Technology-Enhanced
 - Eliminates Gate Lag
 - No insertion loss or phase drift
 - Fast settling time
- Next Gen 0.25 μm Process Technology
- Single-pin 3.3 V CMOS logic control
- High Isolation: 26 dB@ 13.5 GHz
- Low Insertion Loss: 1.7 dB @ 13.5 GHz
- P1dB: 33 dBm typical
- Return Loss: 13 dB @ 13.5 GHz (typ)
- IIP3: +56 dBm typical
- Exceptional ESD: 4000 V HBM
- Absorptive Switch Design
- Flip Chip packaging

Product Description

The PE42556 RF Switch is designed for use in Test/ATE, cellular and other wireless applications. This broadband general purpose switch maintains excellent RF performance and linearity from 9kHz through 13500 MHz. The PE42556 integrates on-board CMOS control logic driven by a single-pin, low voltage CMOS control input. It also has a logic select pin which enables changing the logic definition of the control pin. Additional features include a novel user defined logic table, enabled by the on-board CMOS circuitry. The PE42556 also exhibits excellent isolation of 26 dB at 13500 MHz, fast settling time, and is offered in a tiny Flip Chip package.

The PE42556 is manufactured on Peregrine's UltraCMOS™ process, a patented variation of silicon-on-insulator (SOI) technology on a sapphire substrate, offering the performance of GaAs with the economy and integration of conventional CMOS.

Figure 1. Functional Diagram

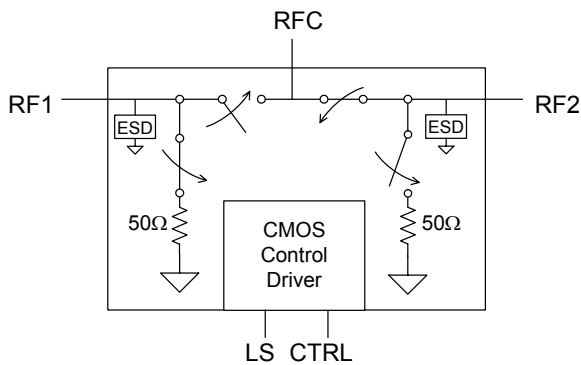

Figure 2. Die Photo (Bumps Up)

Flip Chip Packaging

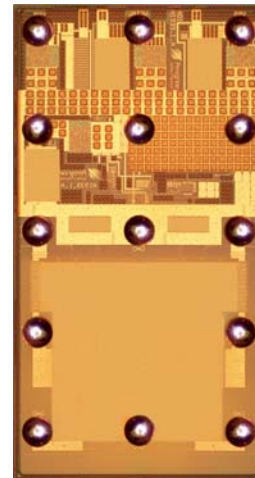

Table 1. Electrical Specifications: Temp = 25°C, V_{DD} = 3.3V

Parameter	Conditions	Min	Typical	Max	Units
Operation Frequency		9 kHz		13500 MHz	As shown
Insertion Loss	9 kHz - 10 MHz		0.85	0.93	dB
	10 - 3000 MHz		0.92	1.06	dB
	3000 - 7500 MHz		0.98	1.23	dB
	7500 - 10000 MHz		1.07	1.41	dB
	10000 - 13500 MHz		1.74	2.65	dB
Isolation – RF1 to RF2	9 kHz - 10 MHz	76.5	88.5		dB
	10 - 3000 MHz	43.5	46.0		dB
	3000 - 7500 MHz	30.0	31.5		dB
	7500 - 10000 MHz	24.0	25.5		dB
	10000 - 13500 MHz	15.5	17.5		dB
Isolation – RFC to RF1	9 kHz - 10 MHz	72.5	84.0		dB
	10 - 3000 MHz	39.0	40.5		dB
	3000 - 7500 MHz	31.5	33.0		dB
	7500 - 10000 MHz	27.0	30.5		dB
	10000 - 13500 MHz	21.5	26.5		dB
Isolation – RFC to RF2	9 kHz - 10 MHz	75.5	87.0		dB
	10 - 3000 MHz	39.5	41.0		dB
	3000 - 7500 MHz	31.5	33.0		dB
	7500 - 10000 MHz	27.5	30.5		dB
	10000 - 13500 MHz	21.0	26.0		dB
Return Loss	9 kHz - 10 MHz		22.5		dB
	10 - 3000 MHz		22.0		dB
	3000 - 7500 MHz		17.0		dB
	7500 - 10000 MHz		16.0		dB
	10000 - 13500 MHz		13.0		dB
Settling Time	50% CTRL to 0.05 dB final value (-40 to +85 °C) Rising Edge		8.5	10.0	µs
	50% CTRL to 0.05 dB final value (-40 to +85 °C) Falling Edge		9.5	13.5	µs
Switching Time	50% CTRL to 90% or 10% of final value (-40 to +85 °C)		3.3	4.0	µs
Input 1 dB Compression ^{1,2}	13500 MHz		33		dBm
Input IP3 ¹	13500 MHz		56		dBm
Input IP2 ¹	13500 MHz		107.5		dBm

Note: 1. Linearity and power performance are derated at lower frequencies (< 1 MHz)
2. Please refer to Maximum Operating Pin (50Ω) in Table 3

Figure 3. Bump Configuration (Bumps Up)

Flip Chip Packaging

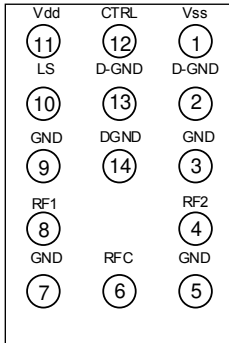

Table 2. Bump Descriptions

Bump No.	Bump Name	Description
1	V _{SS}	Negative supply voltage or GND connection (Note 3)
2, 13, 14	D-GND	Digital Ground
3, 5, 7, 9	GND	Ground
4	RF2	RF Port 2
6	RFC	RF Common
8	RF1	RF Port 1
10	LS	Logic Select - Used to determine the definition for the CTRL pin (see Table 5)
11	V _{DD}	Nominal 3.3 V supply connection
12	CTRL	CMOS logic level

Note: 3. Use VSS (bump 1, VSS = -VDD) to bypass and disable internal negative voltage generator. Connect VSS (bump 1) to GND (VSS = 0V) to enable internal negative voltage generator.

Table 3. Operating Ranges

Parameter	Min	Typ	Max	Units
V _{DD} Positive Power Supply Voltage	3.0	3.3	3.6	V
V _{DD} Negative Power Supply Voltage	-3.6	-3.3	-3.0	V
I _{DD} Power Supply Current (V _{SS} = -3.3V, V _{DD} = 3.0 to 3.6V, -40 to +85 °C)		8.0	12.5	µA
I _{DD} Power Supply Current (V _{SS} = 0V, V _{DD} = 3.0 to 3.6V, -40 to +85 °C)		21.5	29.0	µA
I _{SS} Negative Power Supply Current (V _{SS} = -3.3V, V _{DD} = 3.0 to 3.6V, -40 to +85 °C)		-18.0	-24.0	µA
Control Voltage High	0.7xV _{DD}			V
Control Voltage Low			0.3xV _{DD}	V
P _{IN} RF Power In ⁴ (50Ω): 9 kHz ≤ 1 MHz 1 MHz ≤ 13.5 GHz			fig. 4,5 30	dBm dBm

Note: 4. Please consult Figures 4 and 5 (low-frequency graphs) for recommended low-frequency operating power level.

Table 4. Absolute Maximum Ratings

Symbol	Parameter/Conditions	Min	Max	Units
V _{DD}	Power supply voltage	-0.3	4.0	V
V _I	Voltage on any input except for CTRL and LS inputs	-0.3	V _{DD} +0.3	V
V _{CTRL}	Voltage on CTRL input		4.0	V
V _{LS}	Voltage on LS input		4.0	V
T _{ST}	Storage temperature range	-65	150	°C
T _{OP}	Operating temperature range	-40	85	°C
P _{IN} ⁵ (50Ω)	9 kHz ≤ 1 MHz 1 MHz ≤ 13.5 GHz		fig. 4,5 30	dBm dBm
V _{ESD}	ESD voltage (HBM) ⁶ ESD voltage (Machine Model)		4000 300	V V

Note: 5. Please consult Figures 4 and 5 (low-frequency graphs) for recommended low-frequency operating power level.

6. Human Body Model (HBM, MIL_STD 883 Method 3015.7)

Exceeding absolute maximum ratings may cause permanent damage. Operation should be restricted to the limits in the Operating Ranges table. Operation between operating range maximum and absolute maximum for extended periods may reduce reliability.

Electrostatic Discharge (ESD) Precautions

When handling this UltraCMOS™ device, observe the same precautions that you would use with other ESD-sensitive devices. Although this device contains circuitry to protect it from damage due to ESD, precautions should be taken to avoid exceeding the rating specified.

Latch-Up Avoidance

Unlike conventional CMOS devices, UltraCMOS™ devices are immune to latch-up.

Table 5. Control Logic Truth Table

LS	CTRL	RFC-RF1	RFC-RF2
0	0	off	on
0	1	on	off
1	0	on	off
1	1	off	on

Logic Select (LS)

The Logic Select feature is used to determine the definition for the CTRL pin.

Spurious Performance

The typical spurious performance of the PE42556 is -116 dBm when VSS=0V (bump 1 = GND). If further improvement is desired, the internal negative voltage generator can be disabled by setting VSS = -VDD.

Switching Frequency

The PE42556 has a maximum 25 kHz switching rate when the internal negative voltage generator is used (bump1=GND). The rate at which the PE42556 can be switched is only limited to the switching time (Table 1) if an external negative supply is provided (bump1=VSS).

Low Frequency Power Handling: $Z_L = 50\Omega$

Figure 4 provides guidelines of how to adjust the Vdd and Input Power to the PE42556 device. The upper limit curve represents the maximum Input Power vs Vdd recommended for this part at low frequencies only. Please consult Table 3 for the 1 MHz \leq 13.5 GHz range.

Figure 4. Maximum Operating Power Limit vs. Vdd and Input Power @ 9 KHz

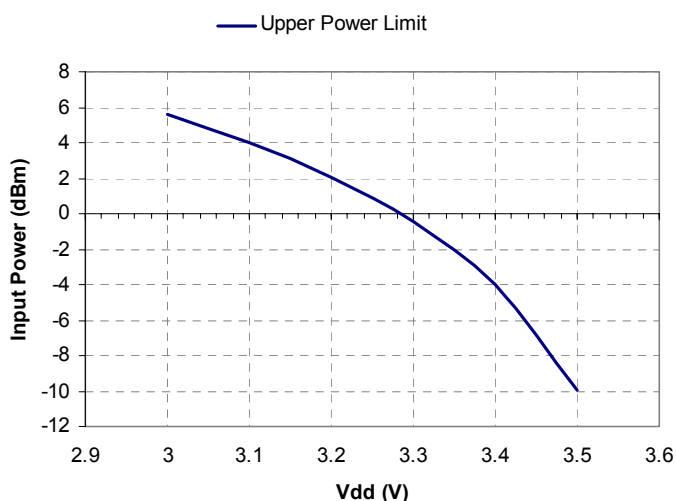

To allow for sustained operation under any load VSWR condition, max power should be kept 6dB lower than max power in 50 Ohm.

Figure 5 shows how the power limit in Figure 4 will increase with frequency. As the frequency increases, the contours and Maximum Power Limit Curve will increase with the increase in power handling shown on the curve.

Figure 5. Operating Power Offset vs. Frequency (Normalized to 9kHz)

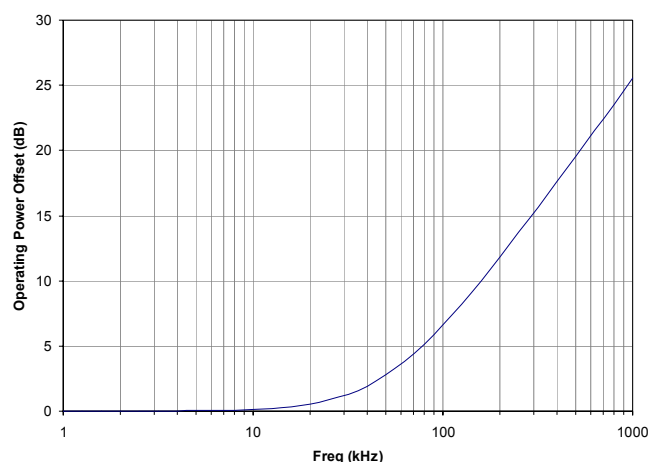

Power Handling Examples

Example 1: Maximum power handling at 100 kHz, $Z=50$ ohms, VSWR 1:1, and Vdd=3V

- The power handling offset for 100 kHz from Fig. 5 is 7 dB
- The max power handling at Vdd = 3 V is 5.5 dB from Fig. 4
- Derate power under mismatch conditions
- Total maximum power handling for this example is 7 dB + 5.5 dB = 12.5 dBm

Evaluation Kit

The SPDT switch EK Board was designed to ease customer evaluation of Peregrine's PE42556 (dual use with PE42554). The RF Common port is connected through a 50ohm transmission line via the top SMA connector, J1. RF1 and RF2 are connected through 50ohm transmission lines via SMA connectors J3, and J2, respectively. A through 50ohm transmission line is available via SMA connectors J4 and J5. This transmission line can be used to estimate the loss of the PCB over the environmental conditions being evaluated.

The board is constructed of a four metal layers with a total thickness of 62 mils. The top and bottom layers are ROGERS RO4003 material with an 8 mil core and Er=3.55. The middle layers provide ground for the transmission lines. The RF transmission lines were designed using a coplanar waveguide with ground plane model using a trace width of 15 mils, and trace gaps of 10 mils.

Figure 6. Evaluation Board Layouts
Peregrine Specification 101/0402

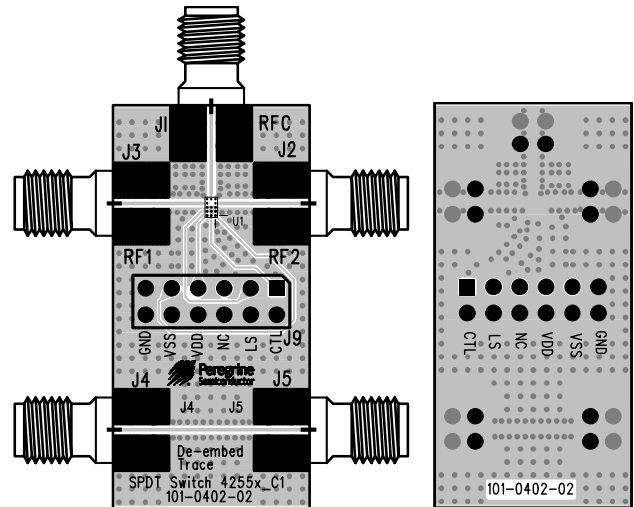
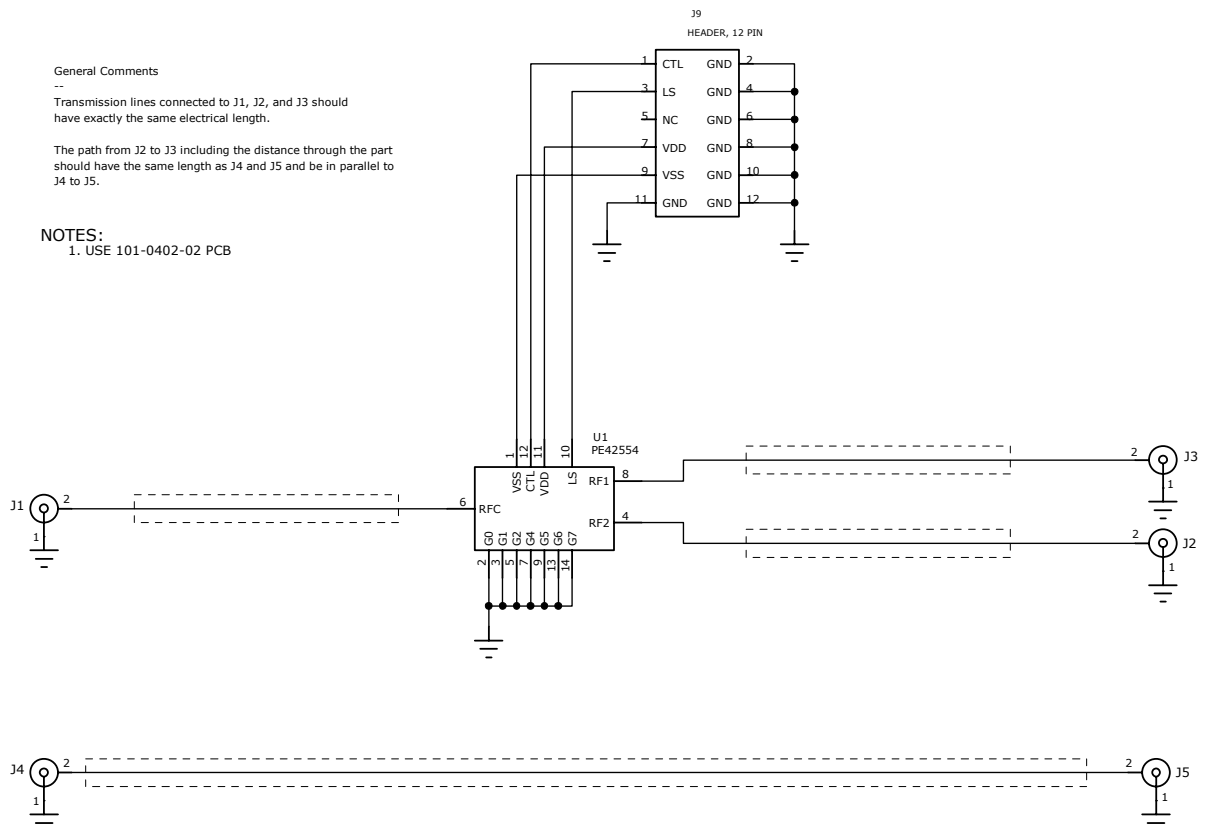

Figure 7. Evaluation Board Schematic
Peregrine Specification 102/0478



Performance Plots: Temperature = 25 °C, $V_{DD} = 3.3$ V unless otherwise indicated

Figure 8. Nominal Insertion Loss: RF1, RF2

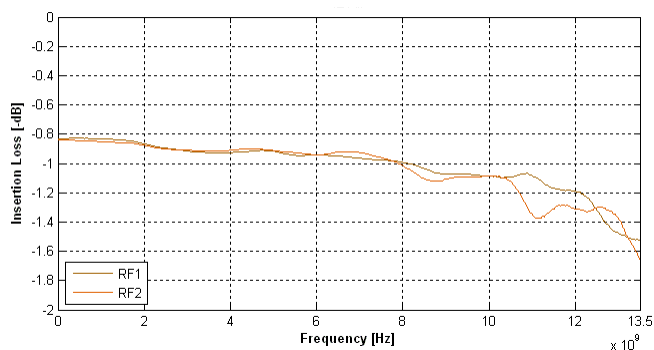

Figure 9. Insertion Loss: RFX @ 3.3 V

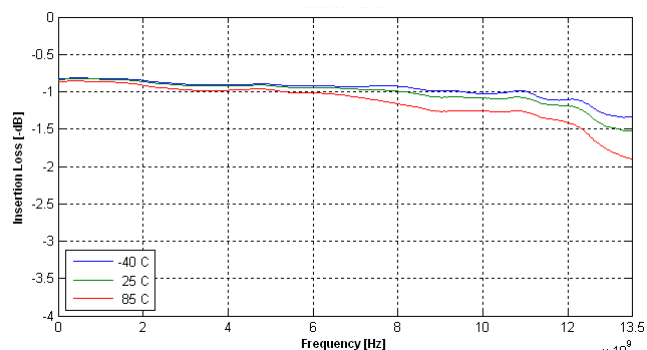

Figure 10. Insertion Loss: RFX @ 25 °C

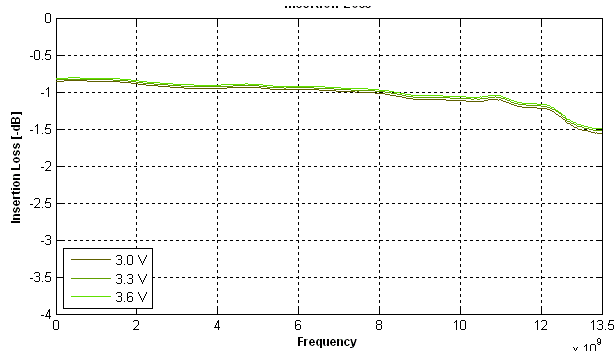

Figure 11. Isolation: Active Port to Isolated Port @ 3.3 V

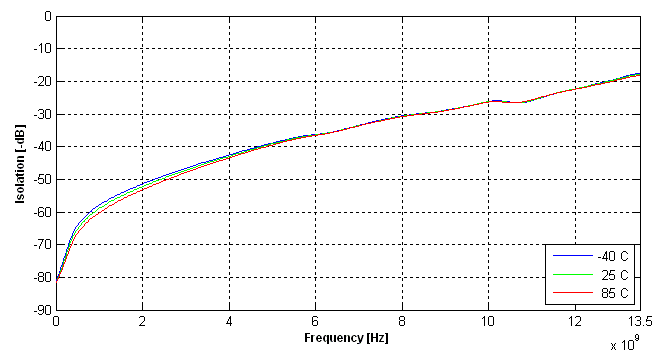

Figure 12. Isolation: Active Port to Isolated Port @ 25 °C

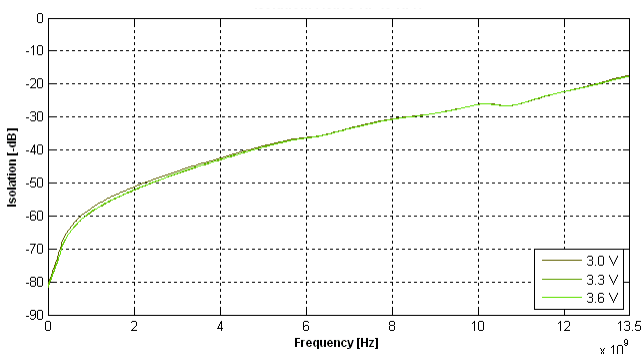
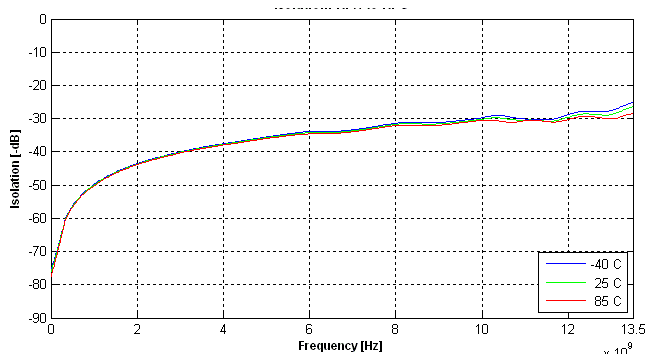

Figure 13. Isolation: RFC to Isolated Port @ 3.3 V



Performance Plots: Temperature = 25 °C, $V_{DD} = 3.3$ V unless otherwise indicated

Figure 14. Isolation: RFC to Isolated Port @ 25 °C

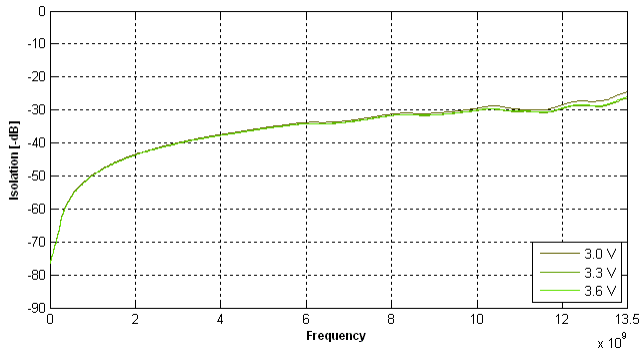

Figure 15. Return Loss at active port @ 3.3 V

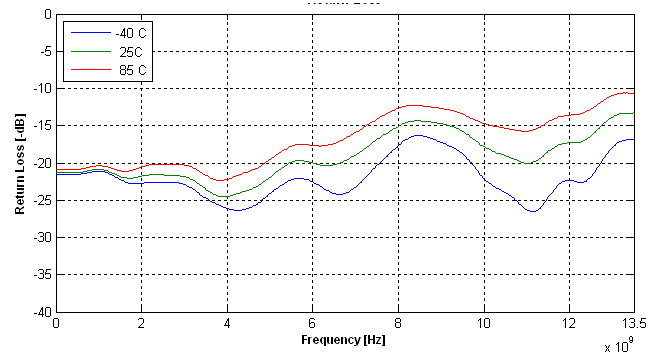

Figure 16. Return Loss at active port @ 25 °C

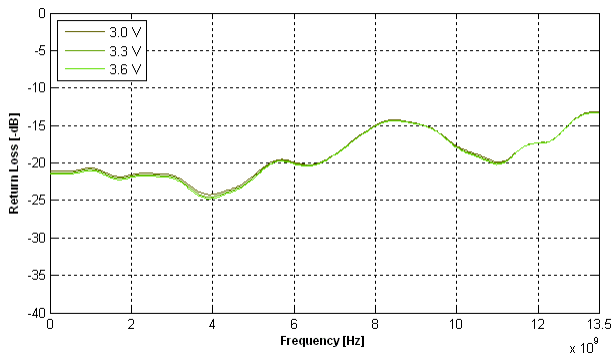

Figure 17. IIP3: Third Order Distortion from 9kHz - 14GHz

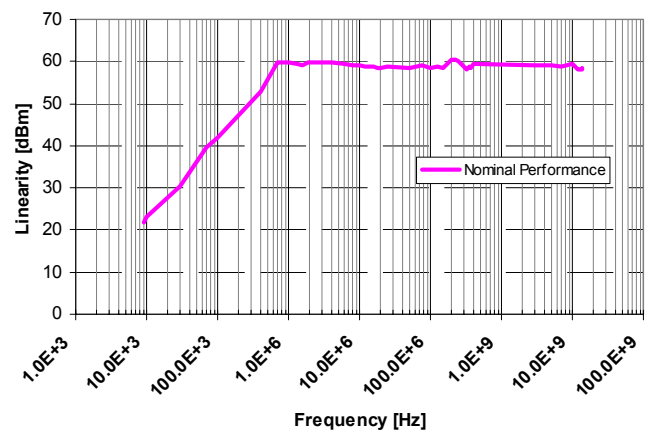

Table 6. Mechanical Specifications

Parameter	Minimum	Typical	Maximum	Units	Test Conditions
Die Size, Drawn (x,y)		996 x 1896		μm	As drawn
Die Size, Singulated (x,y)	1080 x 1980	1100 x 2000	1150 x 2050	μm	Including excess sapphire, max. tolerance = -20/+50 μm
Wafer Thickness	180	200	220	μm	
Wafer Size		150		mm	
Ball Pitch		400		μm	
Ball Height	72.25	85	97.75	μm	
Ball Diameter		110		μm	Typical
UBM Diameter	85	90	95	μm	

RoHS compliant lead-free solder balls

- Solder ball composition: 95.5%Sn/3.5%Ag/ 1.0%Cu

Table 7. Bump Coordinates

Bump #	Bump Name	Bump Center (μm)	
		X	Y
1	VSS	400	850
2	DGND	400	450
3	GND4	400	50
4	RF2	400	-350
5	GND3	400	-750
6	RFC	0	-750
7	GND1	-400	-750
8	RF1	-400	-350
9	GND2	-400	50
10	LS	-400	450
11	VDD	-400	850
12	CTRL	0	850
13	DGND	0	450
14	DGND	0	50

All bump locations originate from the die center and refer to the center of the bump.

Ball pitch is 400 μm.

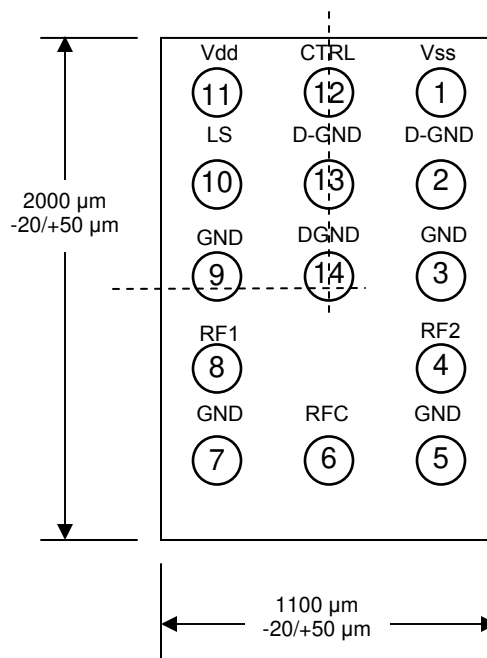
Figure 18. Pad Layout (Bumps Up)

Singulated Die size: 1.1 X 2.0 mm (400um ball pitch)

Figure 19. Tape and Reel Specifications

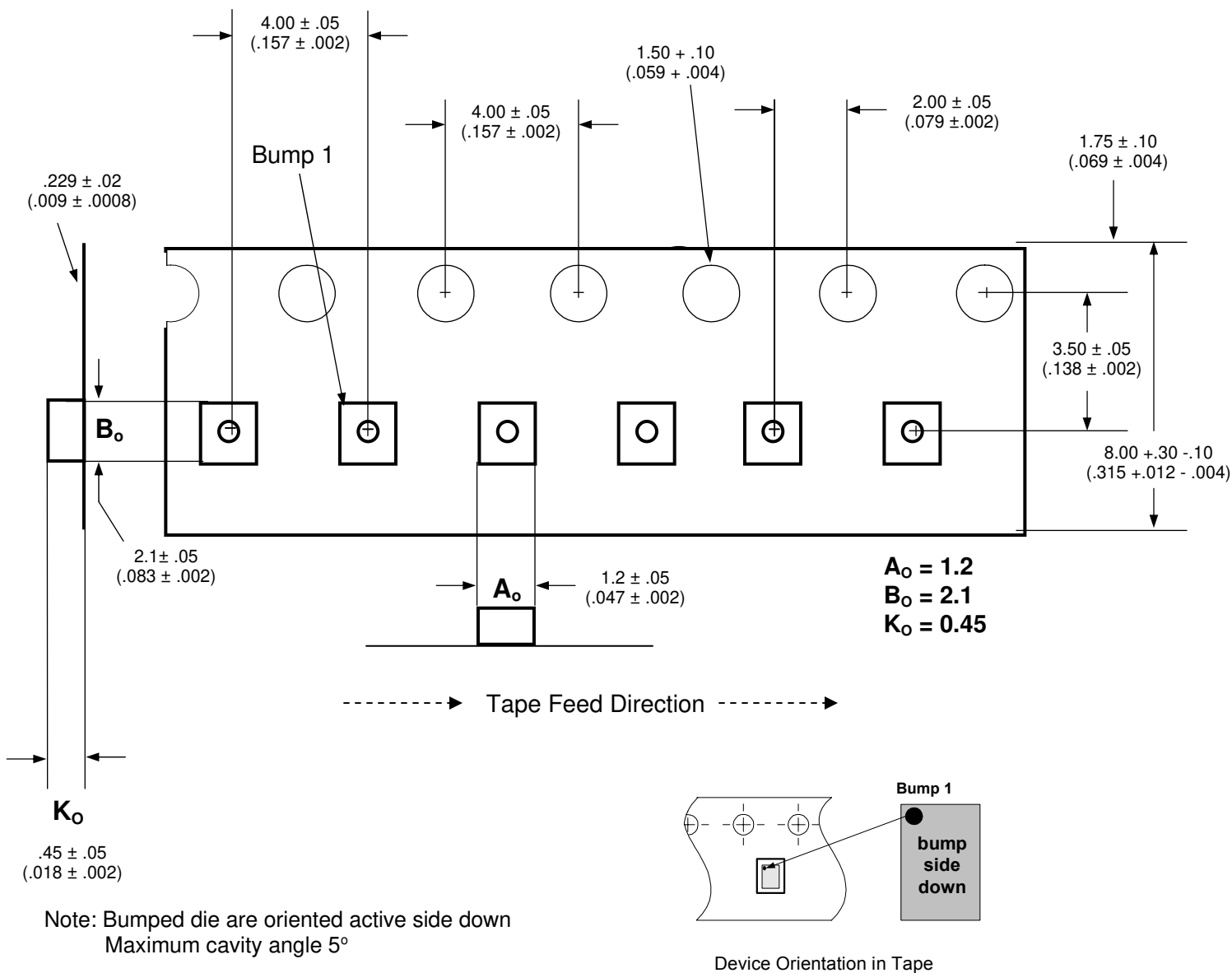

Drawing not drawn to scale, Pocket hole diameter 0.6±0.05mm

Table 8. Ordering Information

Order Code	Package	Specification	Shipping Method
PE42556DI	Die on cut Tape and Reel	81-0012	Loose or cut tape
PE42556DI-Z	Die on full Tape and Reel	81-0012	1,000 Dice / Reel
PE42556DBI	Die in waffle pack	81-0015	204 Dice / Waffle pack
EK42556-01	Evaluation Kit		1/ box

Sales Offices

The Americas

Peregrine Semiconductor Corporation

9380 Carroll Park Drive
San Diego, CA 92121
Tel: 858-731-9400
Fax: 858-731-9499

Europe

Peregrine Semiconductor Europe

Bâtiment Maine
13-15 rue des Quatre Vents
F-92380 Garches, France
Tel: +33-1-4741-9173
Fax : +33-1-4741-9173

High-Reliability and Defense Products

Americas

San Diego, CA, USA
Phone: 858-731-9475
Fax: 848-731-9499

Europe/Asia-Pacific

Aix-En-Provence Cedex 3, France
Phone: +33-4-4239-3361
Fax: +33-4-4239-7227

For a list of representatives in your area, please refer to our Web site at: www.psemi.com

Data Sheet Identification

Advance Information

The product is in a formative or design stage. The data sheet contains design target specifications for product development. Specifications and features may change in any manner without notice.

Preliminary Specification

The data sheet contains preliminary data. Additional data may be added at a later date. Peregrine reserves the right to change specifications at any time without notice in order to supply the best possible product.

Product Specification

The data sheet contains final data. In the event Peregrine decides to change the specifications, Peregrine will notify customers of the intended changes by issuing a CNF (Customer Notification Form).

Peregrine Semiconductor, Asia Pacific (APAC)

Shanghai, 200040, P.R. China
Tel: +86-21-5836-8276
Fax: +86-21-5836-7652

Peregrine Semiconductor, Korea

#B-2607, Kolon Tripolis, 210
Geumgok-dong, Bundang-gu, Seongnam-si
Gyeonggi-do, 463-943 South Korea
Tel: +82-31-728-3939
Fax: +82-31-728-3940

Peregrine Semiconductor K.K., Japan

Teikoku Hotel Tower 10B-6
1-1-1 Uchisaiwai-cho, Chiyoda-ku
Tokyo 100-0011 Japan
Tel: +81-3-3502-5211
Fax: +81-3-3502-5213

The information in this data sheet is believed to be reliable. However, Peregrine assumes no liability for the use of this information. Use shall be entirely at the user's own risk.

No patent rights or licenses to any circuits described in this data sheet are implied or granted to any third party.

Peregrine's products are not designed or intended for use in devices or systems intended for surgical implant, or in other applications intended to support or sustain life, or in any application in which the failure of the Peregrine product could create a situation in which personal injury or death might occur. Peregrine assumes no liability for damages, including consequential or incidental damages, arising out of the use of its products in such applications.

The Peregrine name, logo, and UTSi are registered trademarks and UltraCMOS, HaRP, MultiSwitch and DuNE are trademarks of Peregrine Semiconductor Corp.