



Chipsmall Limited consists of a professional team with an average of over 10 year of expertise in the distribution of electronic components. Based in Hongkong, we have already established firm and mutual-benefit business relationships with customers from,Europe,America and south Asia,supplying obsolete and hard-to-find components to meet their specific needs.

With the principle of "Quality Parts,Customers Priority,Honest Operation,and Considerate Service",our business mainly focus on the distribution of electronic components. Line cards we deal with include Microchip,ALPS,ROHM,Xilinx,Pulse,ON,Everlight and Freescale. Main products comprise IC,Modules,Potentiometer,IC Socket,Relay,Connector.Our parts cover such applications as commercial,industrial, and automotives areas.

We are looking forward to setting up business relationship with you and hope to provide you with the best service and solution. Let us make a better world for our industry!



Contact us

Tel: +86-755-8981 8866 Fax: +86-755-8427 6832

Email & Skype: info@chipsmall.com Web: www.chipsmall.com

Address: A1208, Overseas Decoration Building, #122 Zhenhua RD., Futian, Shenzhen, China



Photoelectrics Through-beam Type PH18CNT..., DC

CARLO GAVAZZI



- Miniature sensor range
- Range: 20 m
- Sensitivity adjustment by potentiometer
- Modulated, infrared light 850 nm
- Supply voltage: 10 to 30 VDC
- Output: 100 mA, NPN or PNP, N.O + N.C.
- Degree of protection IP67, IP69K
- LED indication for output, stability and power ON
- Protection: reverse polarity, short circuit and transients
- Cable, plug and pigtail versions
- Excellent EMC performance



Product Description

The PH18CNT... is part of a family of inexpensive general purpose through-beam sensors in industrial standard 18 mm cylindrical and square ABS housing. The sensors are useful in applications where high-accuracy detection as well as small size is required.

Compact housing and high power LED for excellent performance-size ratio. The potentiometer used for adjustment of the sensitivity makes the sensors highly flexible. The output type is NPN or PNP and the output switching function is NO and NC.

Ordering Key

PH18CNT20PAM1SA

Type	PH18CNT20PAM1SA
Housing style square	PH18CNT20PAM1SA
Housing size	PH18CNT20PAM1SA
Housing material	PH18CNT20PAM1SA
Housing type neutral	PH18CNT20PAM1SA
Detection principle	PH18CNT20PAM1SA
Sensing distance	PH18CNT20PAM1SA
Output type	PH18CNT20PAM1SA
Output configuration	PH18CNT20PAM1SA
Connection type	PH18CNT20PAM1SA
Sensitive adjustment	PH18CNT20PAM1SA

Type Selection

Housing type	Range S _n	Connec- tion	Ordering no. Emitter	Ordering no. Receiver NPN Make or break switching	Ordering no. Receiver PNP Make or break switching
M18 Square type	20 m	Cable	PH 18 CNT 20	PH 18 CNT 20 NASA	PH 18 CNT 20 PASA
M18 Square type	20 m	Plug	PH 18 CNT 20M1	PH 18 CNT 20 NAM1SA	PH 18 CNT 20 PAM1SA
M18 Square type	20 m	Pigtail M12	PH 18 CNT 20T1	PH 18 CNT 20 NAT1SA	PH 18 CNT 20 PAT1SA

Specifications Receiver according to EN60947-5-2

Rated operating distance (S_n)	Up to 20 m	OFF-state current (I_r)	≤ 100 μA
Blind zone	0 mm	Voltage drop (U_d)	≤ 2.0 VDC @ 100 mA
Sensitivity control	Adjustable by potentiometer	Protection	Short-circuit, reverse polarity and transients
Electrical adjustment	210°	Sensing angle	± 4°
Mecanical adjustment	240°	Ambient light	30.000 lux Incandescent lamp
Adjustable distance to target	1 - 20 m	Operating frequency	500 Hz
Temperature drift	≤ 0.2%/°C	Response time	OFF-ON (t _{ON}) ≤ 1.0 ms ON-OFF (t _{OFF}) ≤ 1.0 ms
Hysteresis (H) (differential travel)	≤ 20%	Power ON delay (t_v)	≤ 200 ms
Rated operational volt. (U_B)	10 to 30 VDC (ripple included)	Output function	Type: NPN or PNP Switching function: NO and NC
Ripple (U_{rpp})	≤ 10%	Indication	Output ON: LED, yellow Signal stability and power ON: LED, green
Output current	Continuous (I _a) ≤ 100 mA Short-time (I) ≤ 100 mA (max. load capacity 100 nF)		
No load supply current (I_o)	≤ 15 mA @ 24 VDC		
Minimum operational current (I_m)	0.5 mA		

Specifications Emitter according to EN60947-5-2

Rated operational volt. (U_B)	10 to 30 VDC (ripple included)	Light spot Diameter	Ø 1500 mm @ 10 m
Ripple (U_{rpp})	≤ 10%	Protection	Reverse polarity and transients
Supply current (I_o)	≤ 25 mA @ 24 VDC	Indication function	LED, green
Light source	LED, 850 nm	Power supply ON	LED, green
Light type	Infrared, modulated	Signal stability and power ON	LED, green
Sensing angle	± 4°	Power on delay	< 200 ms

Specifications Common according to EN60947-5-2

Environment		Cable gland	POM, Black
Installation category	III (IEC 60664/60664A; 60947-1)	Trimmer shaft	POM, Dark Grey
Pollution degree	3 (IEC 60664/60664A; 60947-1)	Locknuts	PP, black
Degree of protection	IP 67, IP 69K*	Mounting bracket	PPA, black
Ambient temperature		Connection	
Operating	-25° to +60°C	Cable	PVC, grey, 2 m
Storage	-40° to +70°C	Receiver	4 x 0.25 mm ² , Ø = 4.5 mm
Vibration	10 to 150 Hz, 1.0 mm/15 g (IEC 60068-2-6)	Emitter	2 x 0.25 mm ² , Ø = 4.5 mm
Shock	30 g / 11ms, 3 pos, 3 neg per axis (IEC 60068-2-6, 60068-2-32)	Plug	M12, 4-pin (CONB14NF-series)
Rated insulation voltage	500 VAC (rms)  IEC protection class III	Pigtail	PUR, grey, 30 cm 4 x 0.25 mm ² , Ø = 4.5 mm
Housing material		Weight	With cable: 85 g With Pigtail: 40 g With plug: 25 g
Body	ABS, grey	CE-marking	Yes
Backpart	PC-Transparent	Approvals	cULus (UL508) supply class 2
Front material	PMMA, red		

* The IP69K test according to DIN 40050-9 for high-pressure, high-temperature wash-down applications. The sensor must not only be dust tight (IP6X), but also able to withstand high-pressure and steam cleaning. The sensor is exposed to high pressure water from a spray nozzle that is fed with 80°C water at 8'000-10'000 KPa (80-100bar) and a flow rate of 14-6L/min. The nozzle is held 100 -150 mm from the sensor at angles of 0°, 30°, 60° and 90° for 30s each. The test device sits on a turntable that rotates with a speed of 5 times per minute. The sensor must not suffer any damaging effects from the high pressure water in appearance and function.

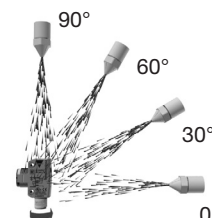

Operation Diagram

tv = Power ON delay

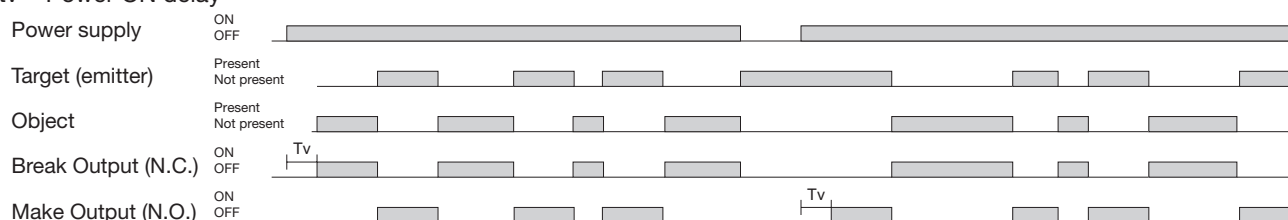

Wiring Diagrams

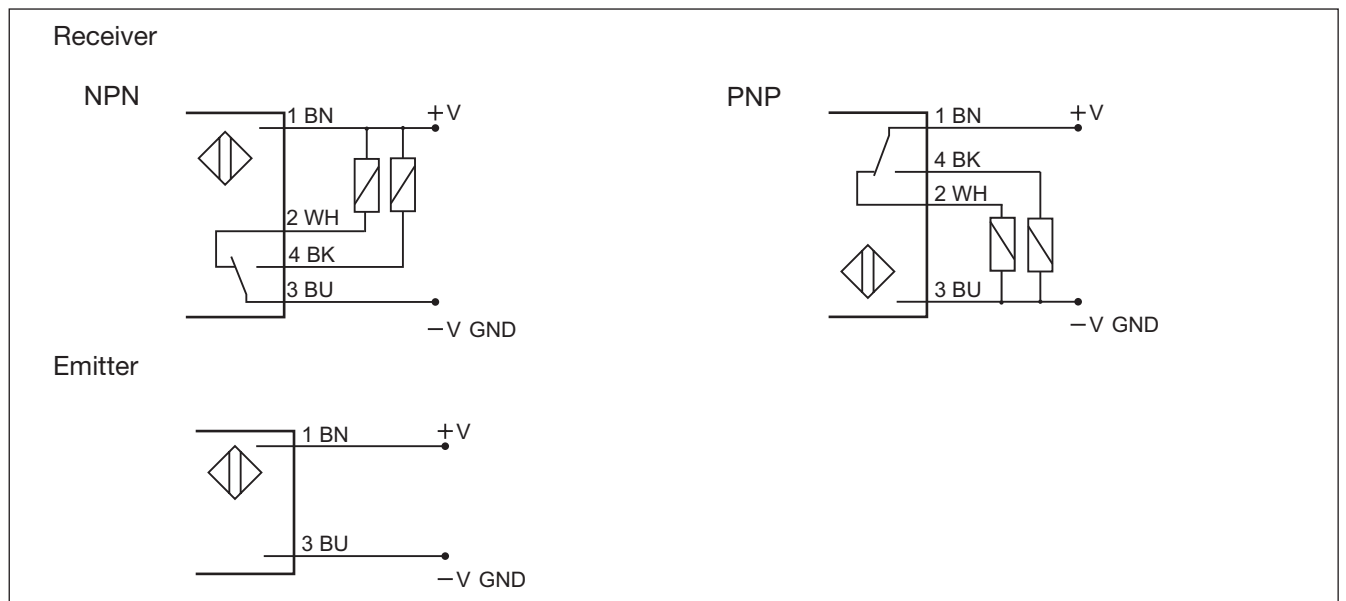

Detection Diagram

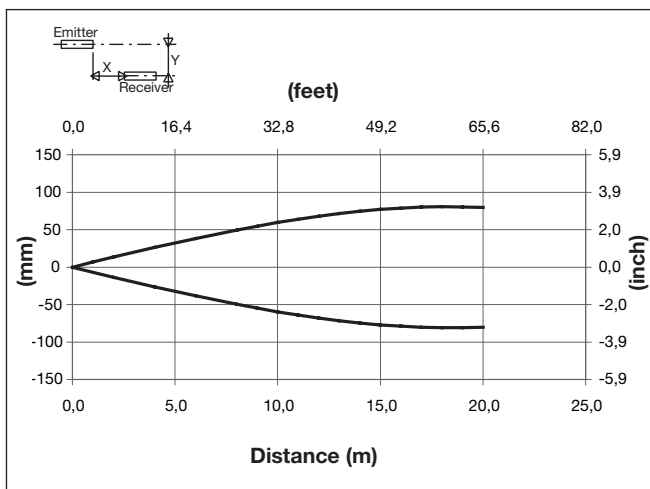

Excess Gain

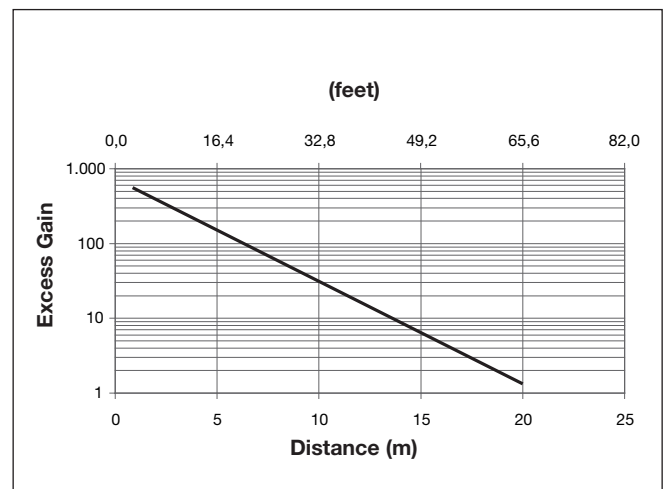

Signal Stability Indication

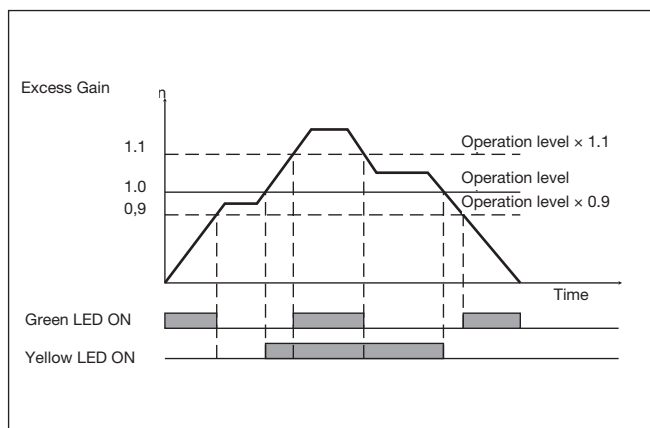

APH18-MB1

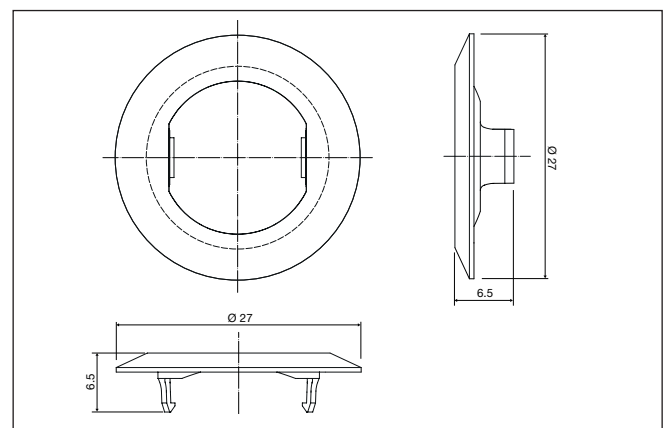

Mounting Systems

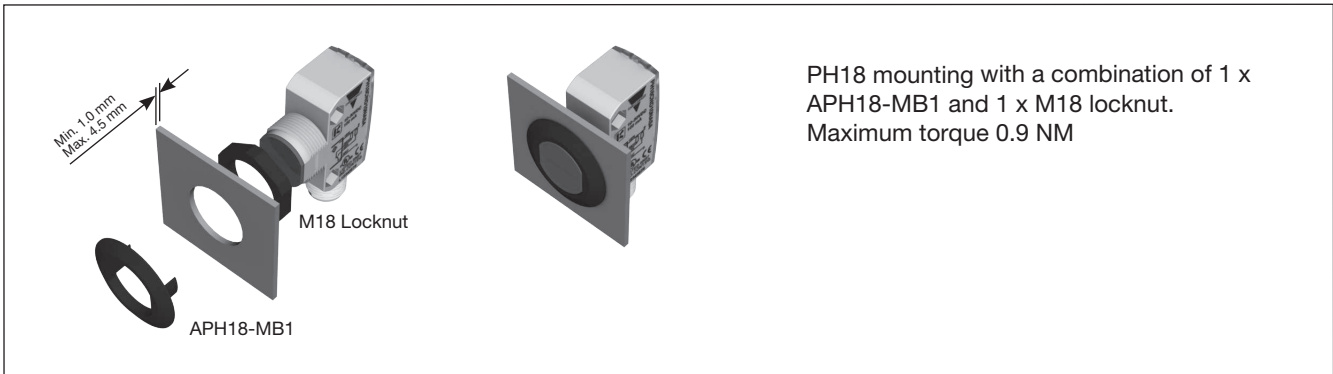

Dimensions

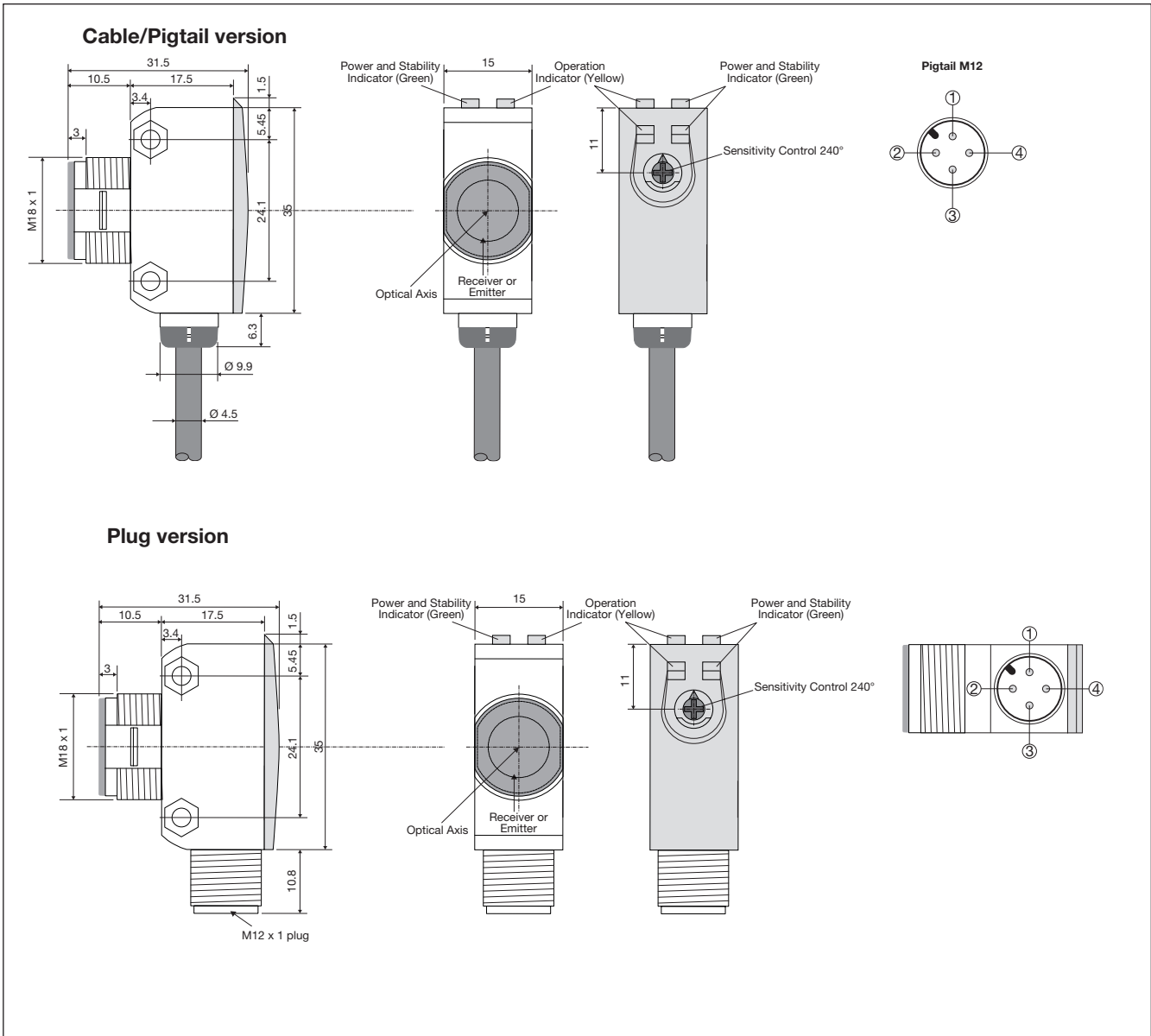

Installation Hints

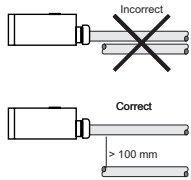
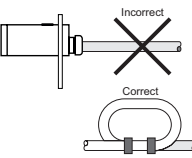
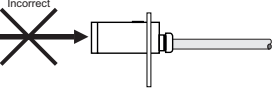
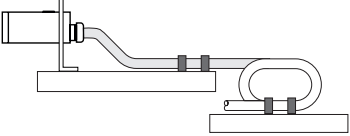
<p><i>To avoid interference from inductive voltage / current peaks, separate the proximity switch cables from any other power cables. E.g. Engine, contactor or solenoid cables</i></p>  <p><i>Incorrect</i></p> <p><i>Correct</i></p> <p><i>> 100 mm</i></p>	<p><i>Relief of the cable strain</i></p>  <p><i>Incorrect</i></p> <p><i>Correct</i></p> <p><i>The cable should not be pulled</i></p>	<p><i>Protection of the sensing face</i></p>  <p><i>Incorrect</i></p> <p><i>A proximity switch should not serve as mechanical stop</i></p>	<p><i>Sensor mounted on a mobile carrier</i></p>  <p><i>Any repetitive flexing of the cable should be avoided</i></p>
---	---	--	--

Delivery Contents

- Photoelectric switch: PH 18 CNT...
- Installation instruction on plastic bag
- Screwdriver
- Mounting bracket APH18-MB1
- 1 M18 locknuts
- **Packaging:** Plastic bag
- Emitter and receiver is packed separately

Accessories

- Connector type CONG1A.. / CONB14NF.. series