



Chipsmall Limited consists of a professional team with an average of over 10 year of expertise in the distribution of electronic components. Based in Hongkong, we have already established firm and mutual-benefit business relationships with customers from,Europe,America and south Asia,supplying obsolete and hard-to-find components to meet their specific needs.

With the principle of “Quality Parts,Customers Priority,Honest Operation,and Considerate Service”,our business mainly focus on the distribution of electronic components. Line cards we deal with include Microchip,ALPS,ROHM,Xilinx,Pulse,ON,Everlight and Freescale. Main products comprise IC,Modules,Potentiometer,IC Socket,Relay,Connector.Our parts cover such applications as commercial,industrial, and automotives areas.

We are looking forward to setting up business relationship with you and hope to provide you with the best service and solution. Let us make a better world for our industry!



Contact us

Tel: +86-755-8981 8866 Fax: +86-755-8427 6832

Email & Skype: info@chipsmall.com Web: www.chipsmall.com

Address: A1208, Overseas Decoration Building, #122 Zhenhua RD., Futian, Shenzhen, China





MICROCHIP

PIC32MX3XX/4XX

Data Sheet

High-Performance,
General Purpose and USB,
32-bit Flash Microcontrollers

Note the following details of the code protection feature on Microchip devices:

- Microchip products meet the specification contained in their particular Microchip Data Sheet.
- Microchip believes that its family of products is one of the most secure families of its kind on the market today, when used in the intended manner and under normal conditions.
- There are dishonest and possibly illegal methods used to breach the code protection feature. All of these methods, to our knowledge, require using the Microchip products in a manner outside the operating specifications contained in Microchip's Data Sheets. Most likely, the person doing so is engaged in theft of intellectual property.
- Microchip is willing to work with the customer who is concerned about the integrity of their code.
- Neither Microchip nor any other semiconductor manufacturer can guarantee the security of their code. Code protection does not mean that we are guaranteeing the product as "unbreakable."

Code protection is constantly evolving. We at Microchip are committed to continuously improving the code protection features of our products. Attempts to break Microchip's code protection feature may be a violation of the Digital Millennium Copyright Act. If such acts allow unauthorized access to your software or other copyrighted work, you may have a right to sue for relief under that Act.

Information contained in this publication regarding device applications and the like is provided only for your convenience and may be superseded by updates. It is your responsibility to ensure that your application meets with your specifications. MICROCHIP MAKES NO REPRESENTATIONS OR WARRANTIES OF ANY KIND WHETHER EXPRESS OR IMPLIED, WRITTEN OR ORAL, STATUTORY OR OTHERWISE, RELATED TO THE INFORMATION, INCLUDING BUT NOT LIMITED TO ITS CONDITION, QUALITY, PERFORMANCE, MERCHANTABILITY OR FITNESS FOR PURPOSE. Microchip disclaims all liability arising from this information and its use. Use of Microchip devices in life support and/or safety applications is entirely at the buyer's risk, and the buyer agrees to defend, indemnify and hold harmless Microchip from any and all damages, claims, suits, or expenses resulting from such use. No licenses are conveyed, implicitly or otherwise, under any Microchip intellectual property rights.

Trademarks

The Microchip name and logo, the Microchip logo, dsPIC, KEELOQ, KEELOQ logo, MPLAB, PIC, PICmicro, PICSTART, PIC³² logo, rPIC and UNI/O are registered trademarks of Microchip Technology Incorporated in the U.S.A. and other countries.

FilterLab, Hampshire, HI-TECH C, Linear Active Thermistor, MXDEV, MXLAB, SEEVAL and The Embedded Control Solutions Company are registered trademarks of Microchip Technology Incorporated in the U.S.A.

Analog-for-the-Digital Age, Application Maestro, CodeGuard, dsPICDEM, dsPICDEM.net, dsPICworks, dsSPEAK, ECAN, ECONOMONITOR, FanSense, HI-TIDE, In-Circuit Serial Programming, ICSP, Mindi, MiWi, MPASM, MPLAB Certified logo, MPLIB, MPLINK, mTouch, Omniscient Code Generation, PICC, PICC-18, PICDEM, PICDEM.net, PICKit, PICtail, REAL ICE, rLAB, Select Mode, Total Endurance, TSHARC, UniWinDriver, WiperLock and ZENA are trademarks of Microchip Technology Incorporated in the U.S.A. and other countries.

SQTP is a service mark of Microchip Technology Incorporated in the U.S.A.

All other trademarks mentioned herein are property of their respective companies.

© 2011, Microchip Technology Incorporated, Printed in the U.S.A., All Rights Reserved.

 Printed on recycled paper.

ISBN: 978-1-61341-149-0

Microchip received ISO/TS-16949:2002 certification for its worldwide headquarters, design and wafer fabrication facilities in Chandler and Tempe, Arizona; Gresham, Oregon and design centers in California and India. The Company's quality system processes and procedures are for its PIC[®] MCUs and dsPIC[®] DSCs, KEELOQ[®] code hopping devices, Serial EEPROMs, microperipherals, nonvolatile memory and analog products. In addition, Microchip's quality system for the design and manufacture of development systems is ISO 9001:2000 certified.

**QUALITY MANAGEMENT SYSTEM
CERTIFIED BY DNV
== ISO/TS 16949:2002 ==**



PIC32MX3XX/4XX

High-Performance, General Purpose and USB 32-bit Flash Microcontrollers

High-Performance 32-bit RISC CPU:

- MIPS32® M4K® 32-bit core with 5-stage pipeline
- 80 MHz maximum frequency
- 1.56 DMIPS/MHz (Dhrystone 2.1) performance at 0 wait state Flash access
- Single-cycle multiply and high-performance divide unit
- MIPS16e® mode for up to 40% smaller code size
- Two sets of 32 core register files (32-bit) to reduce interrupt latency
- Prefetch Cache module to speed execution from Flash

Microcontroller Features:

- Operating temperature range of -40°C to +105°C
- Operating voltage range of 2.3V to 3.6V
- 32K to 512K Flash memory (plus an additional 12 KB of boot Flash)
- 8K to 32K SRAM memory
- Pin-compatible with most PIC24/dsPIC® DSC devices
- Multiple power management modes
- Multiple interrupt vectors with individually programmable priority
- Fail-Safe Clock Monitor Mode
- Configurable Watchdog Timer with on-chip Low-Power RC Oscillator for reliable operation

Peripheral Features:

- Atomic SET, CLEAR and INVERT operation on select peripheral registers
- Up to 4-channel hardware DMA with automatic data size detection
- USB 2.0-compliant full-speed device and On-The-Go (OTG) controller
- USB has a dedicated DMA channel
- 3 MHz to 25 MHz crystal oscillator
- Internal 8 MHz and 32 kHz oscillators

- Separate PLLs for CPU and USB clocks
- Two I²C™ modules
- Two UART modules with:
 - RS-232, RS-485 and LIN support
 - IrDA® with on-chip hardware encoder and decoder
- Up to two SPI modules
- Parallel Master and Slave Port (PMP/PSP) with 8-bit and 16-bit data and up to 16 address lines
- Hardware Real-Time Clock and Calendar (RTCC)
- Five 16-bit Timers/Counters (two 16-bit pairs combine to create two 32-bit timers)
- Five capture inputs
- Five compare/PWM outputs
- Five external interrupt pins
- High-Speed I/O pins capable of toggling at up to 80 MHz
- High-current sink/source (18 mA/18 mA) on all I/O pins
- Configurable open-drain output on digital I/O pins

Debug Features:

- Two programming and debugging Interfaces:
 - 2-wire interface with unintrusive access and real-time data exchange with application
 - 4-wire MIPS® standard enhanced JTAG interface
- Unintrusive hardware-based instruction trace
- IEEE Standard 1149.2-compatible (JTAG) boundary scan

Analog Features:

- Up to 16-channel 10-bit Analog-to-Digital Converter:
 - 1000 ksps conversion rate
 - Conversion available during Sleep, Idle
- Two Analog Comparators

PIC32MX3XX/4XX

TABLE 1: PIC32MX GENERAL PURPOSE – FEATURES

GENERAL PURPOSE														
Device	Pins	Packages ⁽²⁾	MHz	Program Memory (KB)	Data Memory (KB)	Timers/Capture/Compare	Programmable DMA Channels	VREG	Trace	EUART/SPI/I ² C™	10-bit ADC (ch)	Comparators	PMP/PSP	JTAG
PIC32MX320F032H	64	PT, MR	40	32 + 12 ⁽¹⁾	8	5/5/5	0	Yes	No	2/2/2	16	2	Yes	Yes
PIC32MX320F064H	64	PT, MR	80	64 + 12 ⁽¹⁾	16	5/5/5	0	Yes	No	2/2/2	16	2	Yes	Yes
PIC32MX320F128H	64	PT, MR	80	128 + 12 ⁽¹⁾	16	5/5/5	0	Yes	No	2/2/2	16	2	Yes	Yes
PIC32MX340F128H	64	PT, MR	80	128 + 12 ⁽¹⁾	32	5/5/5	4	Yes	No	2/2/2	16	2	Yes	Yes
PIC32MX340F256H	64	PT, MR	80	256 + 12 ⁽¹⁾	32	5/5/5	4	Yes	No	2/2/2	16	2	Yes	Yes
PIC32MX340F512H	64	PT, MR	80	512 + 12 ⁽¹⁾	32	5/5/5	4	Yes	No	2/2/2	16	2	Yes	Yes
PIC32MX320F128L	100	PT	80	128 + 12 ⁽¹⁾	16	5/5/5	0	Yes	No	2/2/2	16	2	Yes	Yes
	121	BG												
PIC32MX340F128L	100	PT	80	128 + 12 ⁽¹⁾	32	5/5/5	4	Yes	No	2/2/2	16	2	Yes	Yes
	121	BG												
PIC32MX360F256L	100	PT	80	256 + 12 ⁽¹⁾	32	5/5/5	4	Yes	Yes	2/2/2	16	2	Yes	Yes
	121	BG												
PIC32MX360F512L	100	PT	80	512 + 12 ⁽¹⁾	32	5/5/5	4	Yes	Yes	2/2/2	16	2	Yes	Yes
	121	BG												

Legend: PT = TQFP MR = QFN BG = XBGA

Note 1: This device features 12 KB Boot Flash memory.

Note 2: See Legend for an explanation of the acronyms. See [Section 30.0 “Packaging Information”](#) for details.

TABLE 2: PIC32MX USB – FEATURES

USB															
Device	Pins	Packages ⁽²⁾	MHz	Program Memory (KB)	Data Memory (KB)	Timers/Capture/Compare	Programmable DMA Channels	Dedicated USB DMA Channels	VREG	Trace	EUART/SPI/I ² C™	10-bit ADC (ch)	Comparators	PMP/PSP	JTAG
PIC32MX420F032H	64	PT, MR	40	32 + 12 ⁽¹⁾	8	5/5/5	0	2	Yes	No	2/1/2	16	2	Yes	Yes
PIC32MX440F128H	64	PT, MR	80	128 + 12 ⁽¹⁾	32	5/5/5	4	2	Yes	No	2/1/2	16	2	Yes	Yes
PIC32MX440F256H	64	PT, MR	80	256 + 12 ⁽¹⁾	32	5/5/5	4	2	Yes	No	2/1/2	16	2	Yes	Yes
PIC32MX440F512H	64	PT, MR	80	512 + 12 ⁽¹⁾	32	5/5/5	4	2	Yes	No	2/1/2	16	2	Yes	Yes
PIC32MX440F128L	100	PT	80	128 + 12 ⁽¹⁾	32	5/5/5	4	2	Yes	No	2/2/2	16	2	Yes	Yes
	121	BG													
PIC32MX460F256L	100	PT	80	256 + 12 ⁽¹⁾	32	5/5/5	4	2	Yes	Yes	2/2/2	16	2	Yes	Yes
	121	BG													
PIC32MX460F512L	100	PT	80	512 + 12 ⁽¹⁾	32	5/5/5	4	2	Yes	Yes	2/2/2	16	2	Yes	Yes
	121	BG													

Legend: PT = TQFP MR = QFN BG = XBGA

Note 1: This device features 12 KB Boot Flash memory.

Note 2: See Legend for an explanation of the acronyms. See [Section 30.0 “Packaging Information”](#) for details.

PIC32MX3XX/4XX

Pin Diagrams

64-Pin QFN (General Purpose)

■ = Pins are up to 5V tolerant

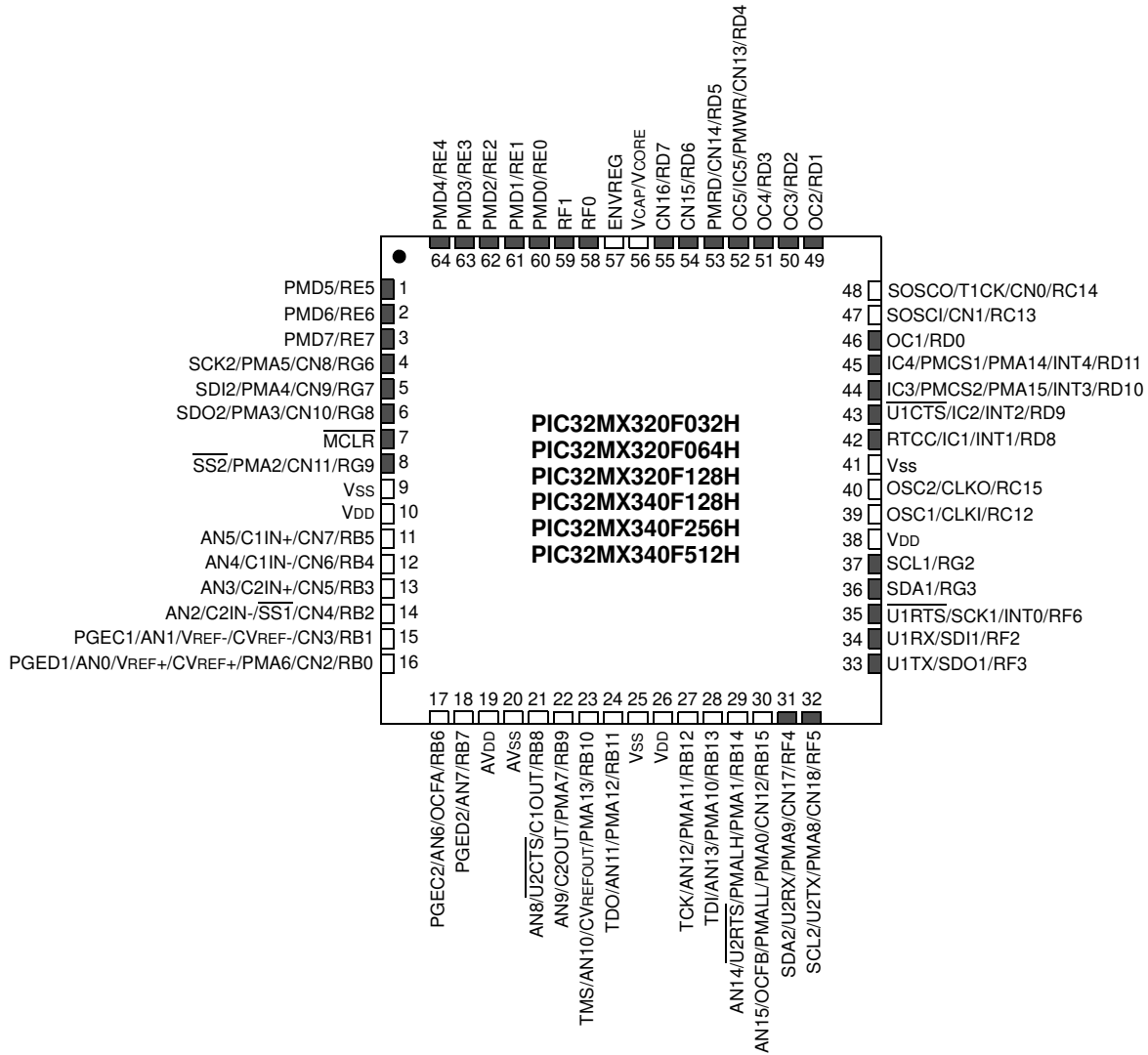

Note: The metal plane at the bottom of the device is not connected to any pins and is recommended to be connected to Vss externally.

Pin Diagrams (Continued)

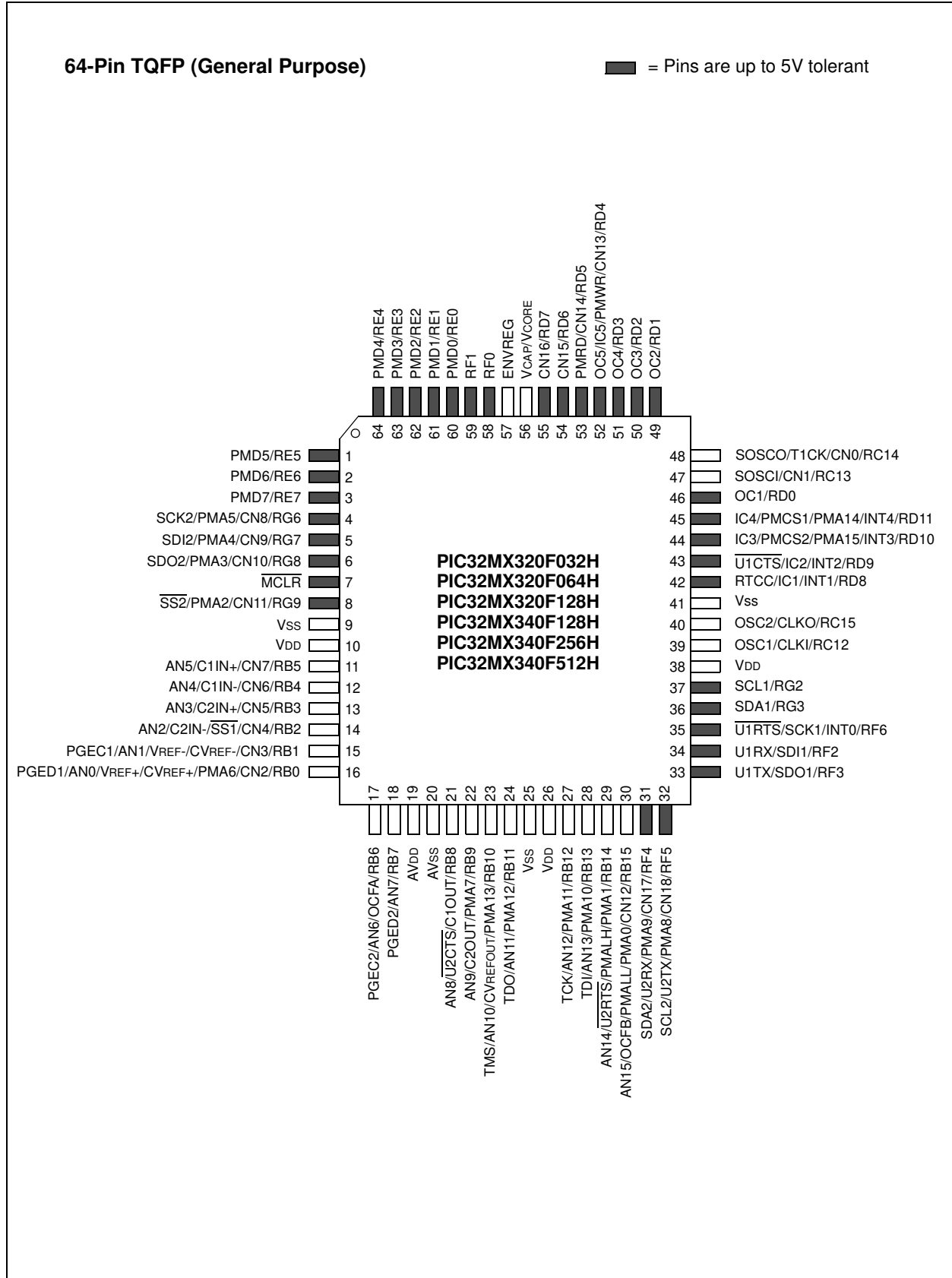

PIC32MX3XX/4XX

Pin Diagrams (Continued)

100-Pin TQFP (General Purpose)

■ = Pins are up to 5V tolerant

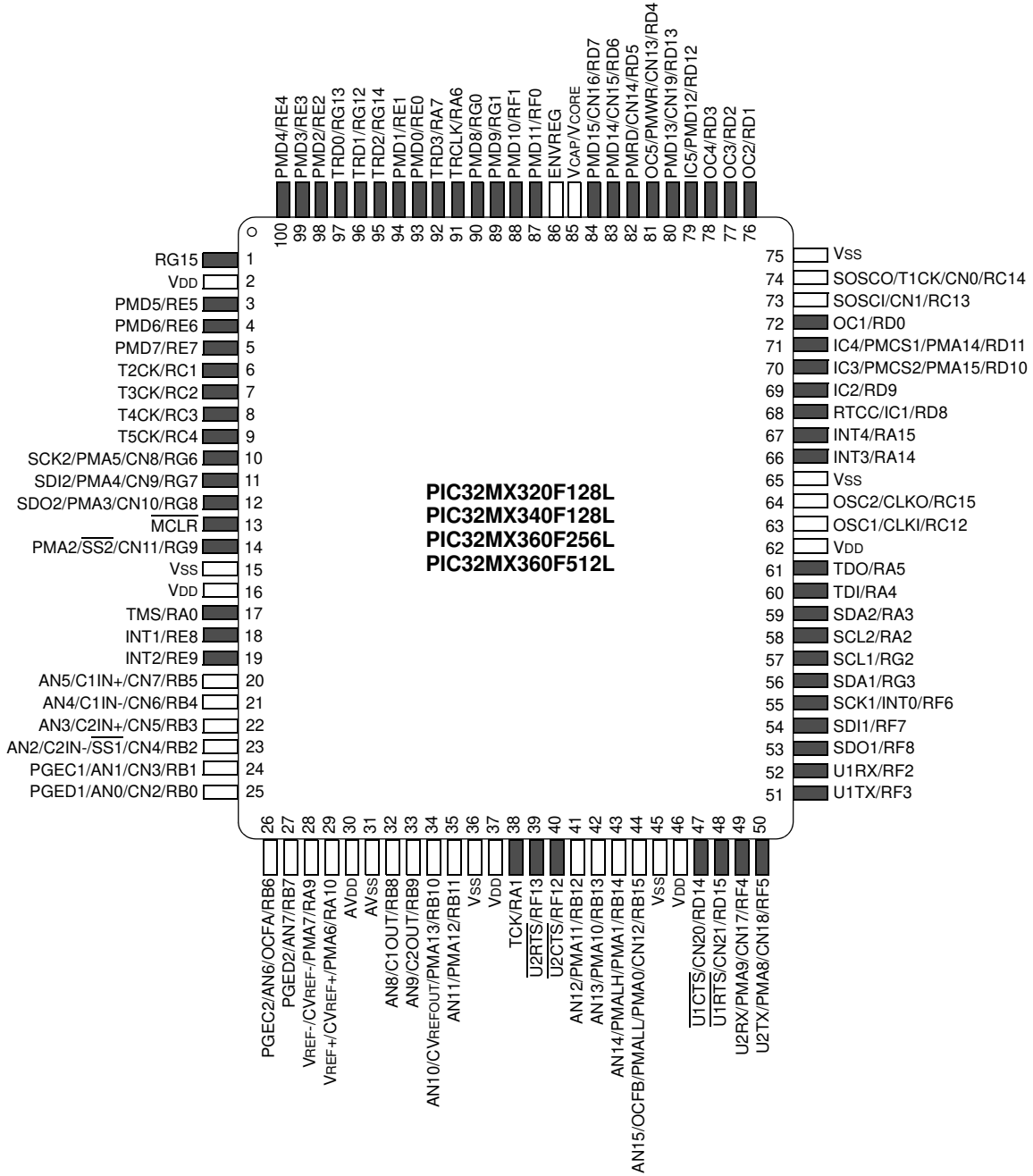

Pin Diagrams (Continued)

121-Pin XBGA⁽¹⁾

● = Pins are up to 5V tolerant

PIC32MX320F128L
 PIC32MX340F128L
 PIC32MX360F256L
 PIC32MX360F512L

	1	2	3	4	5	6	7	8	9	10	11
A	● RE4	● RE3	● RG13	● RE0	● RG0	● RF1	○ ENVREG	○ Vss	● RD12	● RD2	● RD1
B	● NC	● RG15	● RE2	● RE1	● RA7	● RF0	○ V _{CORE} / V _{CAP}	● RD5	● RD3	○ Vss	○ RC14
C	● RE6	○ V _{DD}	● RG12	● RG14	● RA6	● NC	● RD7	● RD4	○ V _{DD}	○ RC13	● RD11
D	● RC1	● RE7	● RE5	○ Vss	○ Vss	● NC	● RD6	● RD13	● RD0	○ NC	● RD10
E	● RC4	● RC3	● RG6	● RC2	○ V _{DD}	● RG1	○ Vss	● RA15	● RD8	● RD9	● RA14
F	● MCLR	● RG8	● RG9	● RG7	○ Vss	● NC	● NC	○ V _{DD}	○ RC12	○ Vss	○ RC15
G	● RE8	● RE9	● RA0	○ NC	○ V _{DD}	○ Vss	○ Vss	● NC	● RA5	● RA3	● RA4
H	○ RB5	○ RB4	○ Vss	○ V _{DD}	● NC	○ V _{DD}	● NC	● RF7	● RF6	● RG2	● RA2
J	○ RB3	○ RB2	○ RB7	○ AV _{DD}	○ RB11	○ RA1	○ RB12	● NC	○ NC	● RF8	○ RG3
K	○ RB1	○ RB0	○ RA10	○ RB8	● NC	● RF12	○ RB14	○ V _{DD}	● RD15	● RF3	● RF2
L	○ RB6	○ RA9	○ AV _{SS}	○ RB9	○ RB10	● RF13	○ RB13	○ RB15	● RD14	● RF4	● RF5

Note 1: Refer to [Table 3](#) for full pin names.

PIC32MX3XX/4XX

TABLE 3: PIN NAMES: PIC32MX320F128L, PIC32MX340F128L, PIC32MX360F128L, AND PIC32MX360F512L DEVICES

Pin Number	Full Pin Name
A1	PMD4/RE4
A2	PMD3/RE3
A3	TRD0/RG13
A4	PMD0/RE0
A5	PMD8/RG0
A6	PMD10/RF1
A7	ENVREG
A8	Vss
A9	IC5/PMD12/RD12
A10	OC3/RD2
A11	OC2/RD1
B1	No Connect (NC)
B2	RG15
B3	PMD2/RE2
B4	PMD1/RE1
B5	TRD3/RA7
B6	PMD11/RF0
B7	VCAP/VCORE
B8	PMRD/CN14/RD5
B9	OC4/RD3
B10	Vss
B11	SOSCO/T1CK/CN0/RC14
C1	PMD6/RE6
C2	VDD
C3	TRD1/RG12
C4	TRD2/RG14
C5	TRCLK/RA6
C6	No Connect (NC)
C7	PMD15/CN16/RD7
C8	OC5/PMWR/CN13/RD4
C9	VDD
C10	SOSCI/CN1/RC13
C11	IC4/PMCS1/PMA14/RD11
D1	T2CK/RC1
D2	PMD7/RE7
D3	PMD5/RE5
D4	Vss
D5	Vss
D6	No Connect (NC)
D7	PMD14/CN15/RD6
D8	PMD13/CN19/RD13
D9	OC1/RD0
D10	No Connect (NC)
D11	IC3/PMCS2/PMA15/RD10
E1	T5CK/RC4
E2	T4CK/RC3
E3	SCK2/PMA5/CN8/RG6
E4	T3CK/RC2
E5	VDD
E6	PMD9/RG1
E7	Vss

Pin Number	Full Pin Name
E8	INT4/RA15
E9	RTCC/IC1/RD8
E10	IC2/RD9
E11	INT3/RA14
F1	MCLR
F2	SDO2/PMA3/CN10/RG8
F3	SS2/PMA2/CN11/RG9
F4	SDI2/PMA4/CN9/RG7
F5	Vss
F6	No Connect (NC)
F7	No Connect (NC)
F8	VDD
F9	OSC1/CLKI/RC12
F10	Vss
F11	OSC2/CLKO/RC15
G1	INT1/RE8
G2	INT2/RE9
G3	TMS/RA0
G4	No Connect (NC)
G5	VDD
G6	Vss
G7	Vss
G8	No Connect (NC)
G9	TDO/RA5
G10	SDA2/RA3
G11	TDI/RA4
H1	AN5/C1IN+/CN7/RB5
H2	AN4/C1IN-/CN6/RB4
H3	Vss
H4	VDD
H5	No Connect (NC)
H6	VDD
H7	No Connect (NC)
H8	SDI1/RF7
H9	SCK1/INT0/RF6
H10	SCL1/RG2
H11	SCL2/RA2
J1	AN3/C2IN+/CN5/RB3
J2	AN2/C2IN-/SS1/CN4/RB2
J3	PGED2/AN7/RB7
J4	AVDD
J5	AN11/PMA12/RB11
J6	TCK/RA1
J7	AN12/PMA11/RB12
J8	No Connect (NC)
J9	No Connect (NC)
J10	SDO1/RF8
J11	SDA1/RG3
K1	PGEC1/AN1/CN3/RB1
K2	PGED1/AN0/CN2/RB0
K3	VREF+/CVREF+/PMA6/RA10

TABLE 3: PIN NAMES: PIC32MX320F128L, PIC32MX340F128L, PIC32MX360F128L, AND PIC32MX360F512L DEVICES (CONTINUED)

Pin Number	Full Pin Name
K4	AN8/C1OUT/RB8
K5	No Connect (NC)
K6	$\overline{U2CTS}$ /RF12
K7	AN14/PMALH/PMA1/RB14
K8	VDD
K9	$\overline{U1RTS}$ /CN21/RD15
K10	U1TX/RF3
K11	U1RX/RF2
L1	PGEC2/AN6/OCFA/RB6
L2	VREF-/CVREF-/PMA7/RA9

Pin Number	Full Pin Name
L3	AVSS
L4	AN9/C2OUT/RB9
L5	AN10/CVREFOUT/PMA13/RB10
L6	$\overline{U2RTS}$ /RF13
L7	AN13/PMA10/RB13
L8	AN15/OCFB/PMALL/PMA0/CN12/RB15
L9	CN20/ $\overline{U1CTS}$ /RD14
L10	U2RX/PMA9/CN17/RF4
L11	U2TX/PMA8/CN18/RF5

PIC32MX3XX/4XX

Pin Diagrams (Continued)

64-Pin QFN (USB)

■ = Pins are up to 5V tolerant

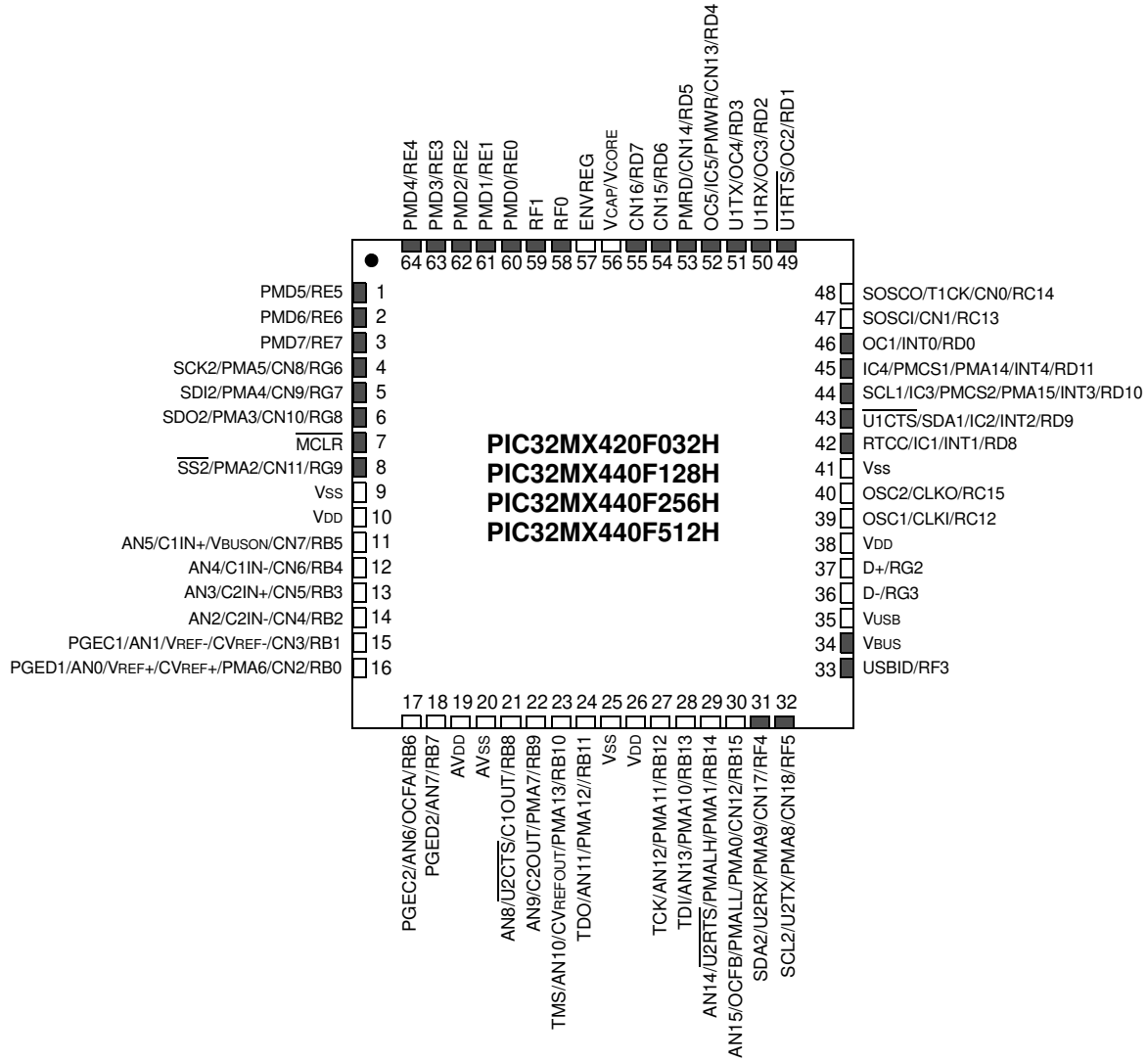

Note: The metal plane at the bottom of the device is not connected to any pins and is recommended to be connected to Vss externally.

Pin Diagrams (Continued)

64-Pin TQFP (USB)

■ = Pins are up to 5V tolerant

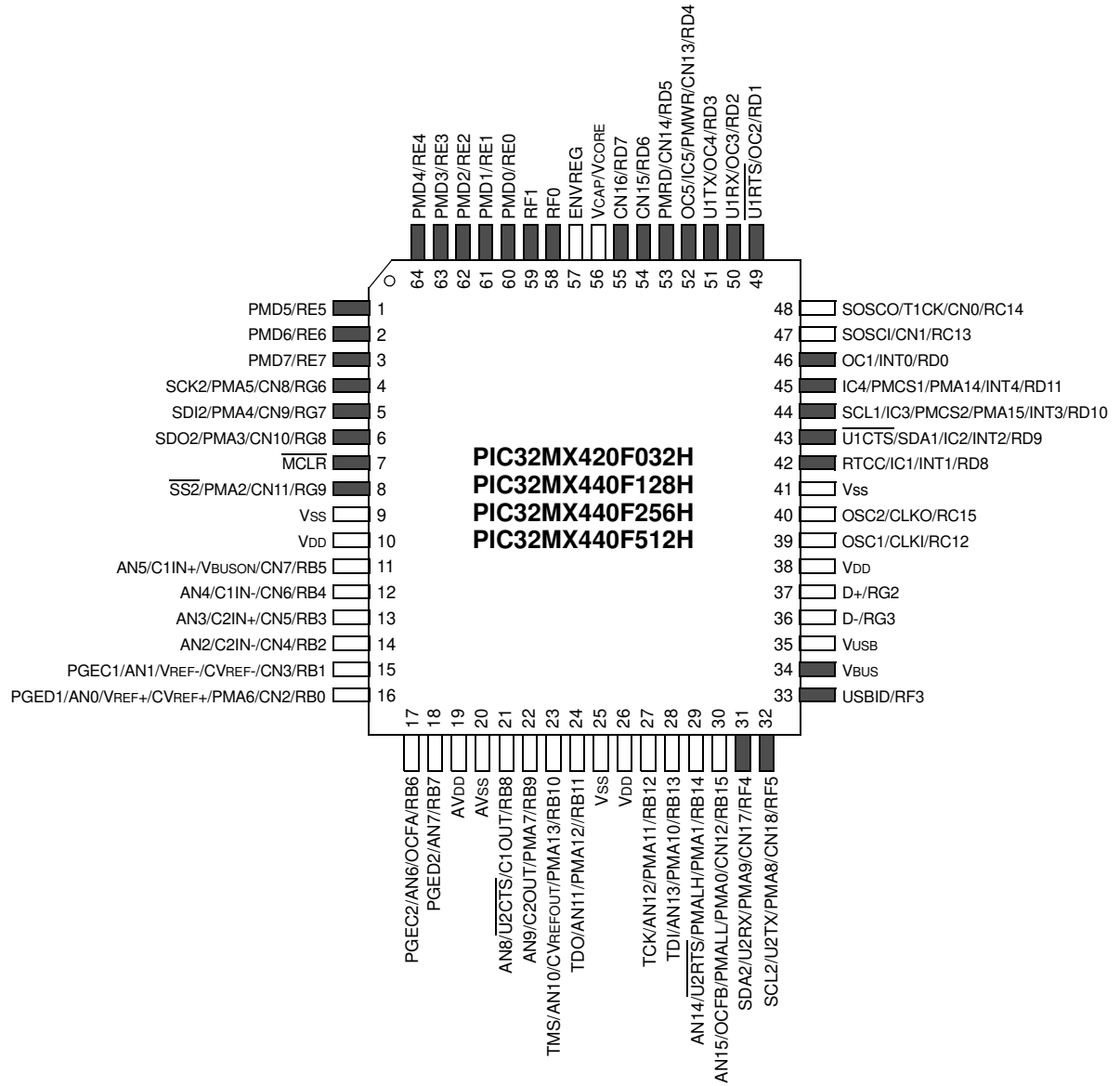

PIC32MX3XX/4XX

Pin Diagrams (Continued)

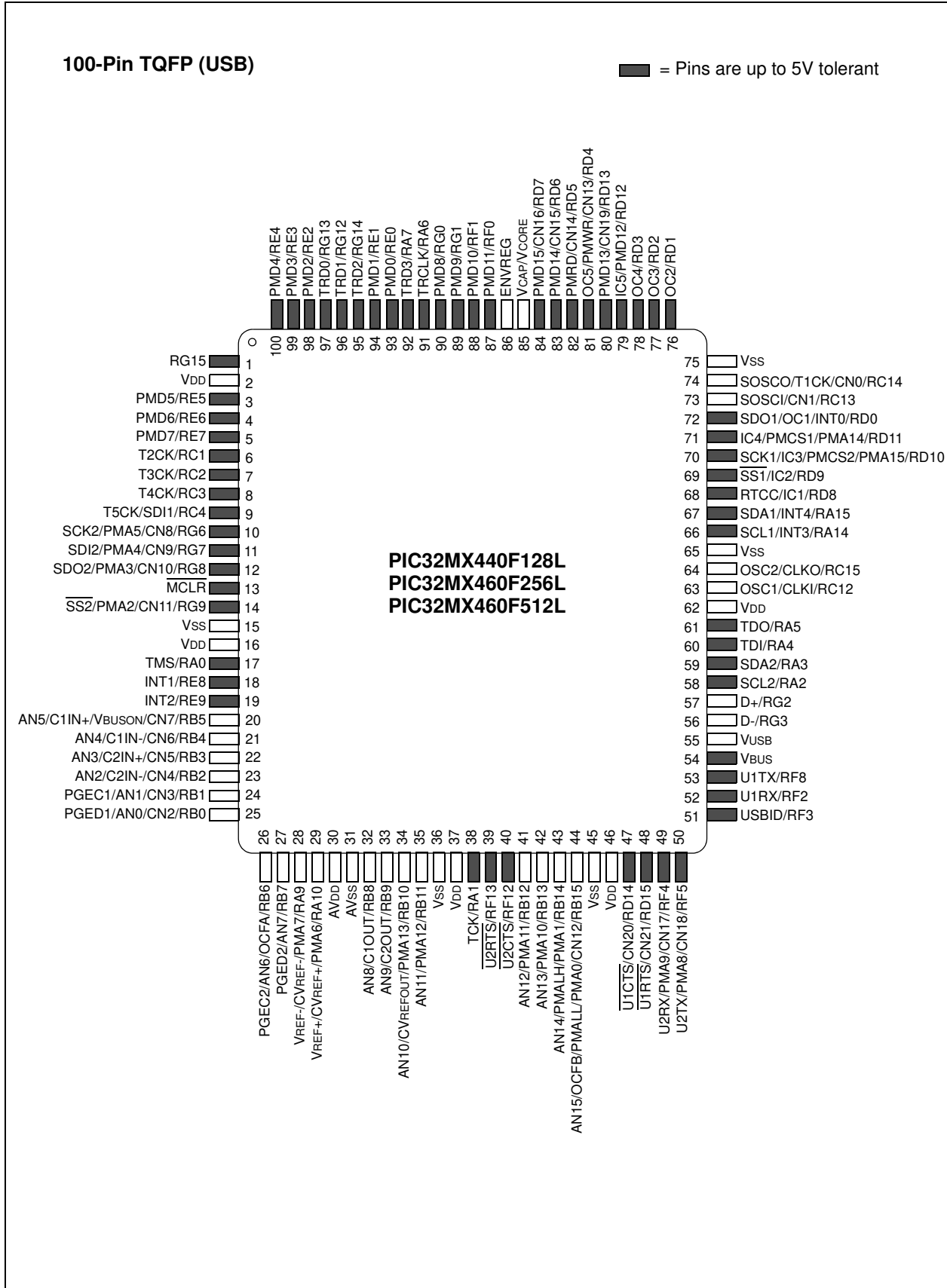

Pin Diagrams (Continued)

121-Pin XBGA⁽¹⁾

● = Pins are up to 5V tolerant

PIC32MX440F128L
 PIC32MX460F256L
 PIC32MX460F512L

	1	2	3	4	5	6	7	8	9	10	11
A	● RE4	● RE3	● RG13	● RE0	● RG0	● RF1	○ ENVREG	○ Vss	● RD12	● RD2	● RD1
B	● NC	● RG15	● RE2	● RE1	● RA7	● RF0	○ V _{CORE} / V _{CAP}	● RD5	● RD3	○ Vss	○ RC14
C	● RE6	○ V _{DD}	● RG12	● RG14	● RA6	● NC	● RD7	● RD4	○ V _{DD}	○ RC13	● RD11
D	● RC1	● RE7	● RE5	○ Vss	○ Vss	● NC	● RD6	● RD13	● RD0	● NC	● RD10
E	● RC4	● RC3	● RG6	● RC2	○ V _{DD}	● RG1	○ Vss	● RA15	● RD8	● RD9	● RA14
F	● MCLR	● RG8	● RG9	● RG7	○ Vss	● NC	● NC	○ V _{DD}	○ RC12	○ Vss	○ RC15
G	● RE8	● RE9	● RA0	● NC	○ V _{DD}	○ Vss	○ Vss	● NC	● RA5	● RA3	● RA4
H	○ RB5	○ RB4	○ Vss	○ V _{DD}	● NC	○ V _{DD}	● NC	● V _{BUS}	○ V _{USB}	● RG2	● RA2
J	○ RB3	○ RB2	○ RB7	○ AV _{DD}	○ RB11	○ RA1	○ RB12	● NC	● NC	● RF8	○ RG3
K	○ RB1	○ RB0	○ RA10	○ RB8	● NC	● RF12	○ RB14	○ V _{DD}	● RD15	● RF3	● RF2
L	○ RB6	○ RA9	○ AV _{SS}	○ RB9	○ RB10	● RF13	○ RB13	○ RB15	● RD14	● RF4	● RF5

Note 1: Refer to [Table 4](#) for full pin names.

PIC32MX3XX/4XX

TABLE 4: PIN NAMES: PIC32MX440F128L, PIC32MX460F256L AND PIC32MX460F512L DEVICES

Pin Number	Full Pin Name
A1	PMD4/RE4
A2	PMD3/RE3
A3	TRD0/RG13
A4	PMD0/RE0
A5	PMD8/RG0
A6	PMD10/RF1
A7	ENVREG
A8	Vss
A9	IC5/PMD12/RD12
A10	OC3/RD2
A11	OC2/RD1
B1	No Connect (NC)
B2	RG15
B3	PMD2/RE2
B4	PMD1/RE1
B5	TRD3/RA7
B6	PMD11/RF0
B7	VCAP/VCORE
B8	PMRD/CN14/RD5
B9	OC4/RD3
B10	Vss
B11	SOSCO/T1CK/CN0/RC14
C1	PMD6/RE6
C2	VDD
C3	TRD1/RG12
C4	TRD2/RG14
C5	TRCLK/RA6
C6	No Connect (NC)
C7	PMD15/CN16/RD7
C8	OC5/PMWR/CN13/RD4
C9	VDD
C10	SOSCI/CN1/RC13
C11	IC4/PMCS1/PMA14/RD11
D1	T2CK/RC1
D2	PMD7/RE7
D3	PMD5/RE5
D4	Vss
D5	Vss
D6	No Connect (NC)
D7	PMD14/CN15/RD6
D8	CN19/PMD13/RD13
D9	SDO1/OC1/INT0/RD0
D10	No Connect (NC)
D11	SCK1/IC3/PMCS2/PMA15/RD10
E1	T5CK/SDI1/RC4
E2	T4CK/RC3
E3	SCK2/PMA5/CN8/RG6
E4	T3CK/RC2
E5	VDD
E6	PMD9/RG1
E7	Vss

Pin Number	Full Pin Name
E8	SDA1/INT4/RA15
E9	RTCC/IC1/RD8
E10	SS1/IC2/RD9
E11	SCL1/INT3/RA14
F1	MCLR
F2	SDO2/PMA3/CN10/RG8
F3	SS2/PMA2/CN11/RG9
F4	SDI2/PMA4/CN9/RG7
F5	Vss
F6	No Connect (NC)
F7	No Connect (NC)
F8	VDD
F9	OSC1/CLKI/RC12
F10	Vss
F11	OSC2/CLKO/RC15
G1	INT1/RE8
G2	INT2/RE9
G3	TMS/RA0
G4	No Connect (NC)
G5	VDD
G6	Vss
G7	Vss
G8	No Connect (NC)
G9	TDO/RA5
G10	SDA2/RA3
G11	TDI/RA4
H1	AN5/C1IN+/VBUSON/CN7/RB5
H2	AN4/C1IN-/CN6/RB4
H3	Vss
H4	VDD
H5	No Connect (NC)
H6	VDD
H7	No Connect (NC)
H8	VBUS
H9	VUSB
H10	D+/RG2
H11	SCL2/RA2
J1	AN3/C2IN+/CN5/RB3
J2	AN2/C2IN-/CN4/RB2
J3	PGED2/AN7/RB7
J4	AVDD
J5	AN11/PMA12/RB11
J6	TCK/RA1
J7	AN12/PMA11/RB12
J8	No Connect (NC)
J9	No Connect (NC)
J10	U1TX/RF8
J11	D-/RG3
K1	PGEC1/AN1/CN3/RB1
K2	PGED1/AN0/CN2/RB0
K3	VREF+/CVREF+/PMA6/RA10

TABLE 4: PIN NAMES: PIC32MX440F128L, PIC32MX460F256L AND PIC32MX460F512L DEVICES (CONTINUED)

Pin Number	Full Pin Name
K4	AN8/C1OUT/RB8
K5	No Connect (NC)
K6	$\overline{U2CTS}$ /RF12
K7	AN14/PMALH/PMA1/RB14
K8	VDD
K9	$\overline{U1RTS}$ /CN21/RD15
K10	USBID/RF3
K11	U1RX/RF2
L1	PGEC2/AN6/OCFA/RB6
L2	VREF-/CVREF-/PMA7/RA9

Pin Number	Full Pin Name
L3	AVSS
L4	AN9/C2OUT/RB9
L5	AN10/CVREFOUT/PMA13/RB10
L6	$\overline{U2RTS}$ /RF13
L7	AN13/PMA10/RB13
L8	AN15/OCFB/PMALL/PMA0/CN12/RB15
L9	$\overline{U1CTS}$ /CN20/RD14
L10	U2RX/PMA9/CN17/RF4
L11	U2TX/PMA8/CN18/RF5

PIC32MX3XX/4XX

Table of Contents

1.0	Device Overview	21
2.0	Guidelines for Getting Started with 32-bit Microcontrollers	31
3.0	CPU	37
4.0	Memory Organization	43
5.0	Flash Program Memory	85
6.0	Resets	87
7.0	Interrupt Controller	89
8.0	Oscillator Configuration	93
9.0	Prefetch Cache	95
10.0	Direct Memory Access (DMA) Controller	97
11.0	USB On-The-Go (OTG)	99
12.0	I/O Ports	101
13.0	Timer1	103
14.0	Timer2/3 and Timer4/5	105
15.0	Input Capture	107
16.0	Output Compare	109
17.0	Serial Peripheral Interface (SPI)	111
18.0	Inter-Integrated Circuit™ (I ² C™)	113
19.0	Universal Asynchronous Receiver Transmitter (UART)	115
20.0	Parallel Master Port (PMP)	119
21.0	Real-Time Clock and Calendar (RTCC)	121
22.0	10-bit Analog-to-Digital Converter (ADC)	123
23.0	Comparator	125
24.0	Comparator Voltage Reference (CVREF)	127
25.0	Power-Saving Features	129
26.0	Special Features	131
27.0	Instruction Set	141
28.0	Development Support	147
29.0	Electrical Characteristics	151
30.0	Packaging Information	191
	Index	209

TO OUR VALUED CUSTOMERS

It is our intention to provide our valued customers with the best documentation possible to ensure successful use of your Microchip products. To this end, we will continue to improve our publications to better suit your needs. Our publications will be refined and enhanced as new volumes and updates are introduced.

If you have any questions or comments regarding this publication, please contact the Marketing Communications Department via E-mail at docerrors@microchip.com or fax the **Reader Response Form** in the back of this data sheet to (480) 792-4150. We welcome your feedback.

Most Current Data Sheet

To obtain the most up-to-date version of this data sheet, please register at our Worldwide Web site at:

<http://www.microchip.com>

You can determine the version of a data sheet by examining its literature number found on the bottom outside corner of any page. The last character of the literature number is the version number, (e.g., DS30000A is version A of document DS30000).

Errata

An errata sheet, describing minor operational differences from the data sheet and recommended workarounds, may exist for current devices. As device/documentation issues become known to us, we will publish an errata sheet. The errata will specify the revision of silicon and revision of document to which it applies.

To determine if an errata sheet exists for a particular device, please check with one of the following:

- Microchip's Worldwide Web site; <http://www.microchip.com>
- Your local Microchip sales office (see last page)

When contacting a sales office, please specify which device, revision of silicon and data sheet (include literature number) you are using.

Customer Notification System

Register on our web site at www.microchip.com to receive the most current information on all of our products.

PIC32MX3XX/4XX

NOTES:

1.0 DEVICE OVERVIEW

Note 1: This data sheet summarizes the features of the PIC32MX3XX/4XX family of devices. It is not intended to be a comprehensive reference source. To complement the information in this data sheet, refer to the “PIC32 Family Reference Manual”, which is available from the Microchip web site (www.microchip.com/PIC32).

2: Some registers and associated bits described in this section may not be available on all devices. Refer to **Section 4.0 “Memory Organization”** in this data sheet for device-specific register and bit information.

This document contains device-specific information for the PIC32MX3XX/4XX devices.

Figure 1-1 illustrates a general block diagram of the core and peripheral modules in the PIC32MX3XX/4XX family of devices.

Table 1-1 lists the functions of the various pins shown in the pinout diagrams.

FIGURE 1-1: BLOCK DIAGRAM^(1,2)

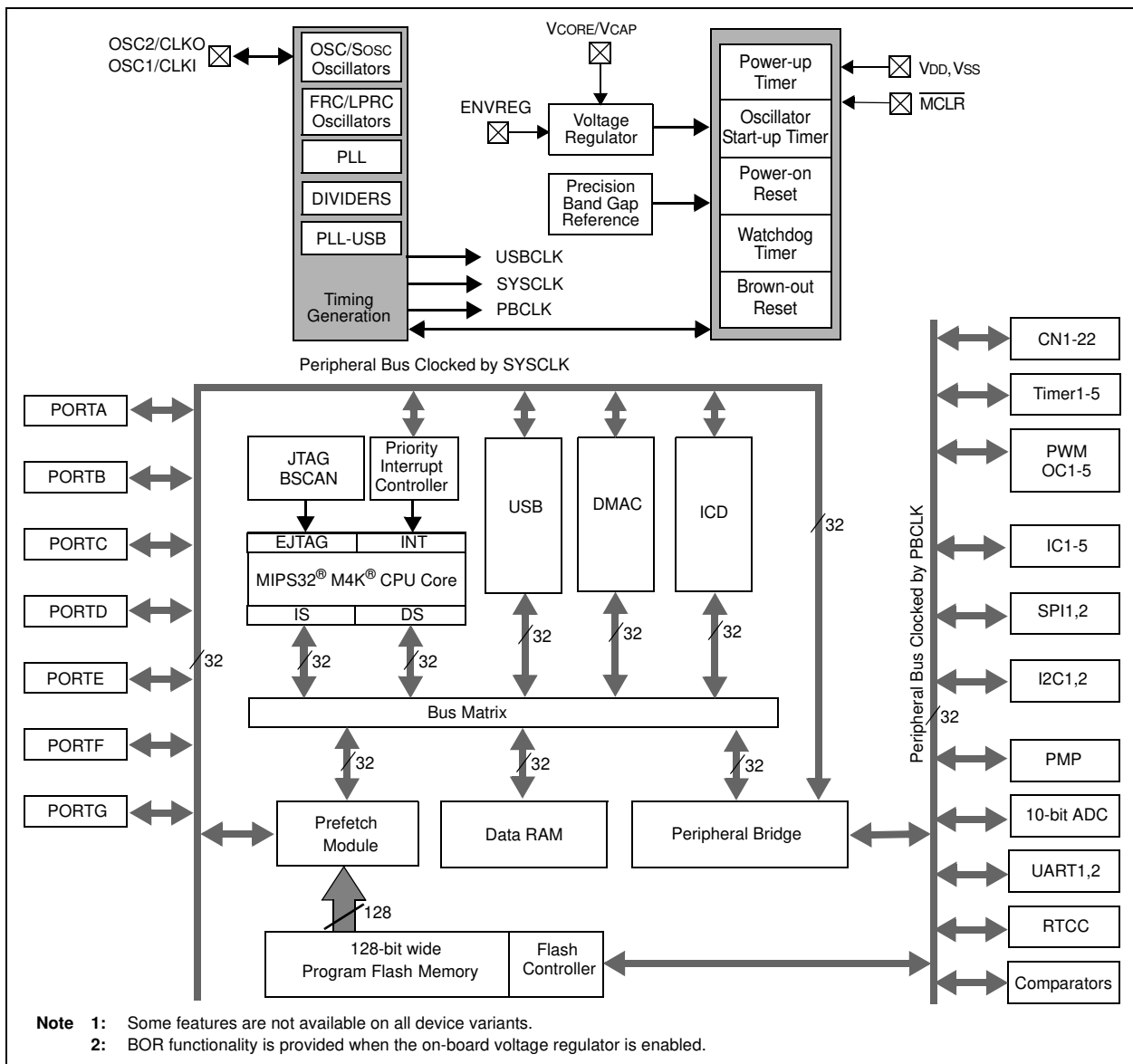

PIC32MX3XX/4XX

TABLE 1-1: PINOUT I/O DESCRIPTIONS

Pin Name	Pin Number ⁽¹⁾			Pin Type	Buffer Type	Description
	64-pin QFN/TQFP	100-pin TQFP	121-pin XBGA			
AN0	16	25	K2	I	Analog	Analog input channels.
AN1	15	24	K1	I	Analog	
AN2	14	23	J2	I	Analog	
AN3	13	22	J1	I	Analog	
AN4	12	21	H2	I	Analog	
AN5	11	20	H1	I	Analog	
AN6	17	26	L1	I	Analog	
AN7	18	27	J3	I	Analog	
AN8	21	32	K4	I	Analog	
AN9	22	33	L4	I	Analog	
AN10	23	34	L5	I	Analog	
AN11	24	35	J5	I	Analog	
AN12	27	41	J7	I	Analog	
AN13	28	42	L7	I	Analog	
AN14	29	43	K7	I	Analog	
AN15	30	44	L8	I	Analog	
CLKI	39	63	F9	I	ST/CMOS	External clock source input. Always associated with OSC1 pin function.
CLKO	40	64	F11	O	—	Oscillator crystal output. Connects to crystal or resonator in Crystal Oscillator mode. Optionally functions as CLKO in RC and EC modes. Always associated with OSC2 pin function.
OSC1	39	63	F9	I	ST/CMOS	Oscillator crystal input. ST buffer when configured in RC mode; CMOS otherwise.
OSC2	40	64	F11	I/O	—	Oscillator crystal output. Connects to crystal or resonator in Crystal Oscillator mode. Optionally functions as CLKO in RC and EC modes.
SOSCI	47	73	C10	I	ST/CMOS	32.768 kHz low-power oscillator crystal input; CMOS otherwise.
SOSCO	48	74	B11	O	—	32.768 kHz low-power oscillator crystal output.

Legend: CMOS = CMOS compatible input or output Analog = Analog input P = Power
 ST = Schmitt Trigger input with CMOS levels O = Output I = Input
 TTL = TTL input buffer

Note 1: Pin numbers are provided for reference only. See the “[Pin Diagrams](#)” section for device pin availability.

TABLE 1-1: PINOUT I/O DESCRIPTIONS (CONTINUED)

Pin Name	Pin Number ⁽¹⁾			Pin Type	Buffer Type	Description
	64-pin QFN/TQFP	100-pin TQFP	121-pin XBGA			
CN0	48	74	B11	I	ST	Change notification inputs. Can be software programmed for internal weak pull-ups on all inputs.
CN1	47	73	C10	I	ST	
CN2	16	25	K2	I	ST	
CN3	15	24	K1	I	ST	
CN4	14	23	J2	I	ST	
CN5	13	22	J1	I	ST	
CN6	12	21	H2	I	ST	
CN7	11	20	H1	I	ST	
CN8	4	10	E3	I	ST	
CN9	5	11	F4	I	ST	
CN10	6	12	F2	I	ST	
CN11	8	14	F3	I	ST	
CN12	30	44	L8	I	ST	
CN13	52	81	C8	I	ST	
CN14	53	82	B8	I	ST	
CN15	54	83	D7	I	ST	
CN16	55	84	C7	I	ST	
CN17	31	49	L10	I	ST	
CN18	32	50	L11	I	ST	
CN19	—	80	D8	I	ST	
CN20	—	47	L9	I	ST	
CN21	—	48	K9	I	ST	
IC1	42	68	E9	I	ST	Capture inputs 1-5.
IC2	43	69	E10	I	ST	
IC3	44	70	D11	I	ST	
IC4	45	71	C11	I	ST	
IC5	52	79	A9	I	ST	
OCFA	17	26	L1	I	ST	Output Compare Fault A Input.
OC1	46	72	D9	O	—	Output Compare output 1.
OC2	49	76	A11	O	—	Output Compare output 2
OC3	50	77	A10	O	—	Output Compare output 3.
OC4	51	78	B9	O	—	Output Compare output 4.
OC5	52	81	C8	O	—	Output Compare output 5.
OCFB	30	44	L8	I	ST	Output Compare Fault B Input.
INT0	35,46	55,72	H9,D9	I	ST	External interrupt 0.
INT1	42	18	61	I	ST	External interrupt 1.
INT2	43	19	62	I	ST	External interrupt 2.

Legend: CMOS = CMOS compatible input or output Analog = Analog input P = Power
 ST = Schmitt Trigger input with CMOS levels O = Output I = Input
 TTL = TTL input buffer

Note 1: Pin numbers are provided for reference only. See the “Pin Diagrams” section for device pin availability.

PIC32MX3XX/4XX

TABLE 1-1: PINOUT I/O DESCRIPTIONS (CONTINUED)

Pin Name	Pin Number ⁽¹⁾			Pin Type	Buffer Type	Description	
	64-pin QFN/TQFP	100-pin TQFP	121-pin XBGA				
INT3	44	66	E11	I	ST	External interrupt 3.	
INT4	45	67	E8	I	ST	External interrupt 4.	
RA0	—	17	G3	I/O	ST	PORTA is a bidirectional I/O port.	
RA1	—	38	J6	I/O	ST		
RA2	—	58	H11	I/O	ST		
RA3	—	59	G10	I/O	ST		
RA4	—	60	G11	I/O	ST		
RA5	—	61	G9	I/O	ST		
RA6	—	91	C5	I/O	ST		
RA7	—	92	B5	I/O	ST		
RA9	—	28	L2	I/O	ST		
RA10	—	29	K3	I/O	ST		
RA14	—	66	E11	I/O	ST		
RA15	—	67	E8	I/O	ST		
RB0	16	25	K2	I/O	ST		PORTB is a bidirectional I/O port.
RB1	15	24	K1	I/O	ST		
RB2	14	23	J2	I/O	ST		
RB3	13	22	J1	I/O	ST		
RB4	12	21	H2	I/O	ST		
RB5	11	20	H1	I/O	ST		
RB6	17	26	L1	I/O	ST		
RB7	18	27	J3	I/O	ST		
RB8	21	32	K4	I/O	ST		
RB9	22	33	L4	I/O	ST		
RB10	23	34	L5	I/O	ST		
RB11	24	35	J5	I/O	ST		
RB12	27	41	J7	I/O	ST		
RB13	28	42	L7	I/O	ST		
RB14	29	43	K7	I/O	ST		
RB15	30	44	L8	I/O	ST		
RC1	—	6	D1	I/O	ST	PORTC is a bidirectional I/O port.	
RC2	—	7	E4	I/O	ST		
RC3	—	8	E2	I/O	ST		
RC4	—	9	E1	I/O	ST		
RC12	39	63	F9	I/O	ST		
RC13	47	73	C10	I/O	ST		
RC14	48	74	B11	I/O	ST		
RC15	40	64	F11	I/O	ST		

Legend: CMOS = CMOS compatible input or output Analog = Analog input P = Power
 ST = Schmitt Trigger input with CMOS levels O = Output I = Input
 TTL = TTL input buffer

Note 1: Pin numbers are provided for reference only. See the “[Pin Diagrams](#)” section for device pin availability.

TABLE 1-1: PINOUT I/O DESCRIPTIONS (CONTINUED)

Pin Name	Pin Number ⁽¹⁾			Pin Type	Buffer Type	Description
	64-pin QFN/TQFP	100-pin TQFP	121-pin XBGA			
RD0	46	72	D9	I/O	ST	PORTD is a bidirectional I/O port.
RD1	49	76	A11	I/O	ST	
RD2	50	77	A10	I/O	ST	
RD3	51	78	B9	I/O	ST	
RD4	52	81	C8	I/O	ST	
RD5	53	82	B8	I/O	ST	
RD6	54	83	D7	I/O	ST	
RD7	55	84	C7	I/O	ST	
RD8	42	68	E9	I/O	ST	
RD9	43	69	E10	I/O	ST	
RD10	44	70	D11	I/O	ST	
RD11	45	71	C11	I/O	ST	
RD12	—	79	A9	I/O	ST	
RD13	—	80	D8	I/O	ST	
RD14	—	47	L9	I/O	ST	
RD15	—	48	K9	I/O	ST	
RE0	60	93	A4	I/O	ST	PORTE is a bidirectional I/O port.
RE1	61	94	B4	I/O	ST	
RE2	62	98	B3	I/O	ST	
RE3	63	99	A2	I/O	ST	
RE4	64	100	A1	I/O	ST	
RE5	1	3	D3	I/O	ST	
RE6	2	4	C1	I/O	ST	
RE7	3	5	D2	I/O	ST	
RE8	—	18	G1	I/O	ST	
RE9	—	19	G2	I/O	ST	
RF0	58	87	B6	I/O	ST	PORTF is a bidirectional I/O port.
RF1	59	88	A6	I/O	ST	
RF2	34	52	K11	I/O	ST	
RF3	33	51	K10	I/O	ST	
RF4	31	49	L10	I/O	ST	
RF5	32	50	L11	I/O	ST	
RF6	35	55	H9	I/O	ST	
RF7	—	54	H8	I/O	ST	
RF8	—	53	J10	I/O	ST	
RF12	—	40	K6	I/O	ST	
RF13	—	39	L6	I/O	ST	

Legend: CMOS = CMOS compatible input or output Analog = Analog input P = Power
 ST = Schmitt Trigger input with CMOS levels O = Output I = Input
 TTL = TTL input buffer

Note 1: Pin numbers are provided for reference only. See the “Pin Diagrams” section for device pin availability.