



Chipsmall Limited consists of a professional team with an average of over 10 year of expertise in the distribution of electronic components. Based in Hongkong, we have already established firm and mutual-benefit business relationships with customers from,Europe,America and south Asia,supplying obsolete and hard-to-find components to meet their specific needs.

With the principle of “Quality Parts,Customers Priority,Honest Operation,and Considerate Service”,our business mainly focus on the distribution of electronic components. Line cards we deal with include Microchip,ALPS,ROHM,Xilinx,Pulse,ON,Everlight and Freescale. Main products comprise IC,Modules,Potentiometer,IC Socket,Relay,Connector.Our parts cover such applications as commercial,industrial, and automotives areas.

We are looking forward to setting up business relationship with you and hope to provide you with the best service and solution. Let us make a better world for our industry!



Contact us

Tel: +86-755-8981 8866 Fax: +86-755-8427 6832

Email & Skype: info@chipsmall.com Web: www.chipsmall.com

Address: A1208, Overseas Decoration Building, #122 Zhenhua RD., Futian, Shenzhen, China



Series: PJ006

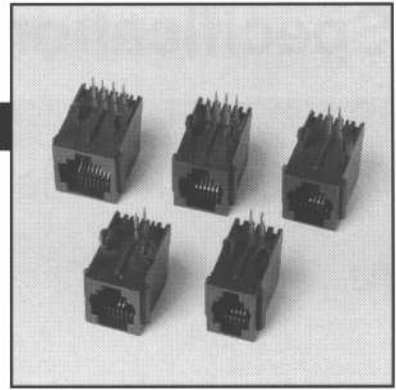

Series options:

F = Flanged

K = Keyed (available only on 8 position)

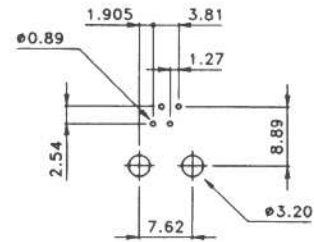
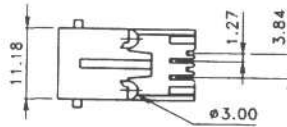
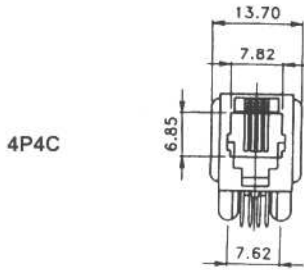

PC Board Layout

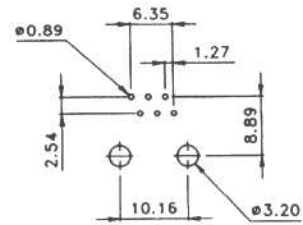
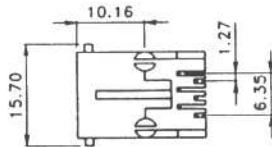
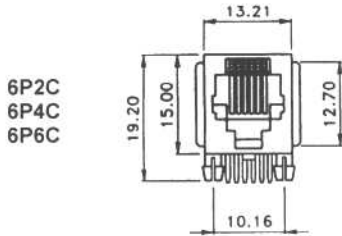

PC Board Layout

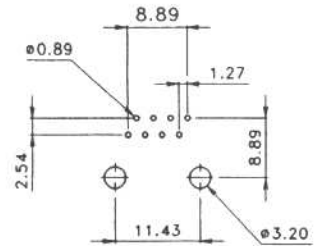
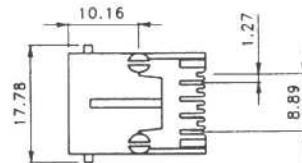
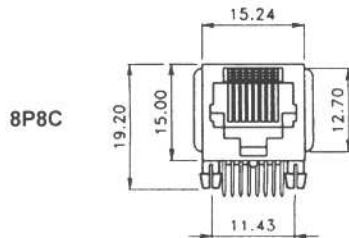

PC Board Layout

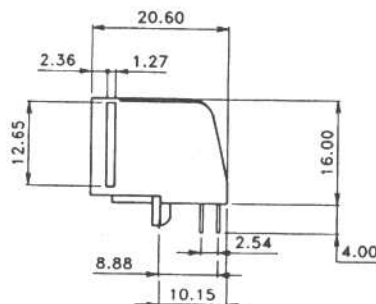

Specifications

Phone Jack Series:

PJ

Ratings:

Current	1.5A
Dielectric strength	1000V RMS for 1 minute
Contact resistance	20mΩ max.
Insulation resistance	500MΩ min.
Spring wire durability	500 mating cycles min.
Operating temperature	-25°C / +90°C

Material:

Plastic	PBT, Glass-filled UL94V-0
Color	Black
Spring wire	0.45mm Dia., Phosphor Bronze Gold plated over Nickel

ORDERING PROCEDURE

1 - 2 3 4 - 5

- 1) Series
- 2) Number of Positions (# P)
- 3) Number of Contacts (# C)
- 4) Plating:

1 = Full Flash Gold
2 = Full 10μ Gold
3 = Full 30μ Gold
4 = Full 50μ Gold

- 5) Series options:

B = Ferrite Bead (only available on PJ031)
F = Flanged
S = Shield
K = Keyed
H = Shorting Bar (available only on PJ008, 8 position)