



Chipsmall Limited consists of a professional team with an average of over 10 year of expertise in the distribution of electronic components. Based in Hongkong, we have already established firm and mutual-benefit business relationships with customers from,Europe,America and south Asia,supplying obsolete and hard-to-find components to meet their specific needs.

With the principle of "Quality Parts,Customers Priority,Honest Operation,and Considerate Service",our business mainly focus on the distribution of electronic components. Line cards we deal with include Microchip,ALPS,ROHM,Xilinx,Pulse,ON,Everlight and Freescale. Main products comprise IC,Modules,Potentiometer,IC Socket,Relay,Connector.Our parts cover such applications as commercial,industrial, and automotives areas.

We are looking forward to setting up business relationship with you and hope to provide you with the best service and solution. Let us make a better world for our industry!



Contact us

Tel: +86-755-8981 8866 Fax: +86-755-8427 6832

Email & Skype: info@chipsmall.com Web: www.chipsmall.com

Address: A1208, Overseas Decoration Building, #122 Zhenhua RD., Futian, Shenzhen, China



Type 4, 4X Polyester Pushbutton Enclosure *PJPBLC* Series



Panel
Sold
Separately



Application

- Designed for use as instrument enclosures, electric, hydraulic or pneumatic control housings, electrical junction boxes or terminal wiring enclosures.
- Provides outstanding insulation and protection where equipment may be hosed down or be very wet.
- Ideal in applications with high temperatures or highly corrosive environments.

Standards

- UL 508 Type 1, 2, 3, 4, 4X, 12 and 13
- CSA Type 1, 2, 3, 4, 4X, 12 and 13
- **Complies with**
 - NEMA Type 1, 2, 3, 4, 4X, 12 and 13
 - IEC 60529, IP66

Construction

- Molded fiberglass polyester enclosure with matching cover is easily punched, cut, or drilled.
- Standard JIC sizes under 18" x 16".
- Threaded brass inserts are provided for optional inner panel or terminal kit mounting.
- Cover is fastened with captive stainless steel screws in threaded brass inserts.
- Captive oil resistant gasket provides a positive seal.
- Threaded brass inserts are provided for mounting feet to the rear of the enclosure.
- Stainless steel mounting brackets and hardware are provided for mounting to the rear of the enclosure.
- Enhanced UV inhibitors protect against outdoor weathering.
- Operating temperatures between 130°C and -40°C (266°F to -40°F).
- Impact index of 6.78J (5 ft/lb).
- For corrosion resistance information, please refer to table in **Technical Information**.

Finish

- Fiberglass polyester material has a gray finish.
- Optional inner panels are available in white powder coated finished steel or unfinished aluminum.

Accessories

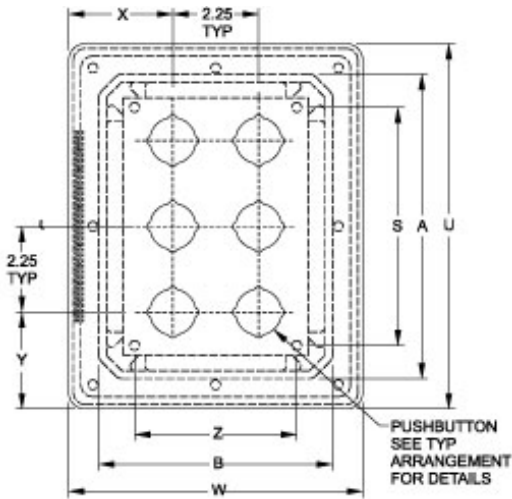

**Top View
Hinged Screw Cover**

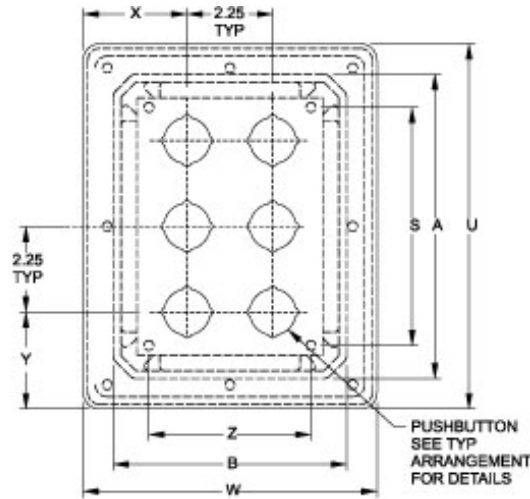

**Top View
Lift Off Screw Cover**

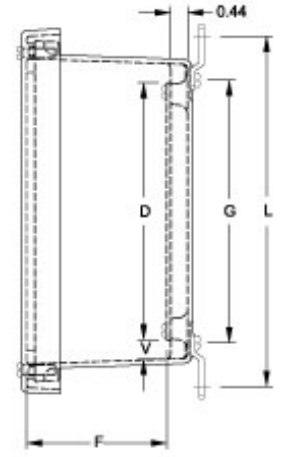

Side View

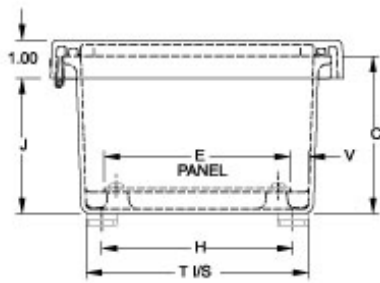

Front View

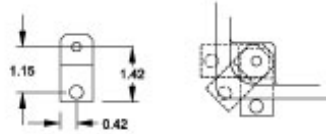

Optional Mounting Feet Locations

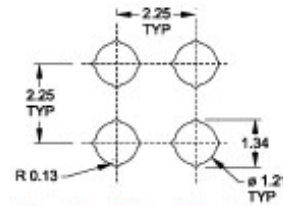

Typical Pushbutton Arrangement

Thermal Index
130°C to -40°C
(266°F to -40°F)
Impact Index
6.78J (5 ft/lb)

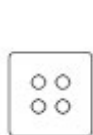

PJ664P4
PJ664HP4

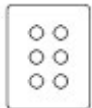

PJ864P6
PJ864HP6



PJ1086P9
PJ1086HP9

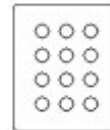

PJ1086P12
PJ1086HP12

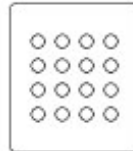

PJ12106P16
PJ12106HP16

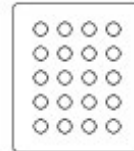

PJ12106P20
PJ12106HP20

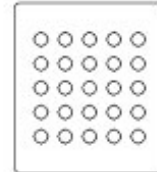

PJ14126P25
PJ14126HP25

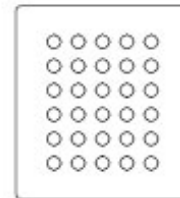

PJ16148P30
PJ16148HP30

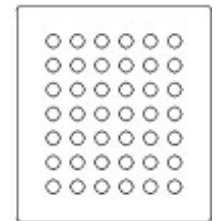

PJ18168P42
PJ18168HP42

Lift Off Cover Part No.	Hinged Cover Part No.	Overall Dimensions			Panel Size				Center			
		A	B	C	D	E	F	G	H	J	S	Z
PJ664P4	PJ664HP4	6.10	6.10	4.18	4.88	4.88	3.76	5.01	5.01	3.52	4.25	4.25
PJ864P6	PJ864HP6	8.00	6.12	4.13	6.75	4.88	3.68	6.89	5.01	3.47	6.25	4.25
PJ1084P9	PJ1084HP9	10.13	8.26	4.13	8.75	6.88	3.68	8.89	7.01	5.47	8.25	6.25
PJ1086P9	PJ1086HP9	10.13	8.26	6.13	8.75	6.88	5.68	8.89	7.01	5.47	8.25	6.25
PJ1086P12	PJ1086HP12	10.13	8.26	6.13	8.75	6.88	5.68	8.89	7.01	5.47	8.25	6.25
PJ12106P16	PJ12106HP16	12.13	10.26	6.13	10.75	8.88	5.68	10.89	9.01	5.47	10.25	8.25
PJ12106P20	PJ12106HP20	12.13	10.26	6.13	10.75	8.88	5.68	10.89	9.01	5.47	10.25	8.25
PJ14126P25	PJ14126HP25	14.13	12.26	6.13	12.75	10.88	5.68	12.89	11.01	5.47	12.25	10.25
PJ16148P30	PJ16148HP30	16.27	14.40	8.13	14.75	12.88	7.68	14.89	13.01	7.47	14.25	12.25
PJ18168P42	PJ18168HP42	18.40	16.40	8.13	16.88	14.88	7.68	16.97	14.97	7.47	16.25	14.25

Lift Off Cover Part No.	Hinged Cover Part No.	Optional					Steel Panel Part No.	No. Holes	Ship		Wt. Lbs.
		L	T	V	U	W			X	Y	
PJ664P4	PJ664HP4	7.32	5.83	0.49	7.69	7.69	14R0505	4	2.72	2.72	4

Lift Off Cover Part No.	Hinged Cover Part No.	Optional					Steel Panel Part No.	No. Holes	X	Y	Ship Wt. Lbs.
		L	T	V	U	W					
PJ864P6	PJ864HP6	9.19	5.85	0.50	9.59	7.71	14R0705	6	2.73	2.55	4
PJ1084P9	PJ1084HP9	11.19	7.85	0.50	11.77	9.90	14R0907	9	2.68	3.62	6
PJ1086P9	PJ1086HP9	11.19	7.85	0.50	11.77	9.90	14R0907	9	2.68	3.62	6
PJ1086P12	PJ1086HP12	11.19	7.85	0.50	11.77	9.90	14R0907	12	2.68	2.49	6
PJ12106P16	PJ12106HP16	13.19	9.85	0.50	13.77	11.90	14R1109	16	2.55	3.49	8
PJ12106P20	PJ12106HP20	13.19	9.85	0.50	13.77	11.90	14R1109	20	2.55	2.37	8
PJ14126P25	PJ14126HP25	15.19	11.85	0.50	15.73	13.85	14R1311	25	2.43	3.37	11
PJ16148P30	PJ16148HP30	17.19	13.71	0.50	17.87	15.99	14R1513	30	3.50	3.31	12
PJ18168P42	PJ18168HP42	19.28	15.72	0.50	20.00	18.00	P1868	42	3.38	3.25	17

Data subject to change without notice

© 2017. Hammond Manufacturing Ltd. All rights reserved.