



Chipsmall Limited consists of a professional team with an average of over 10 year of expertise in the distribution of electronic components. Based in Hongkong, we have already established firm and mutual-benefit business relationships with customers from,Europe,America and south Asia,supplying obsolete and hard-to-find components to meet their specific needs.

With the principle of "Quality Parts,Customers Priority,Honest Operation,and Considerate Service",our business mainly focus on the distribution of electronic components. Line cards we deal with include Microchip,ALPS,ROHM,Xilinx,Pulse,ON,Everlight and Freescale. Main products comprise IC,Modules,Potentiometer,IC Socket,Relay,Connector.Our parts cover such applications as commercial,industrial, and automotives areas.

We are looking forward to setting up business relationship with you and hope to provide you with the best service and solution. Let us make a better world for our industry!



Contact us

Tel: +86-755-8981 8866 Fax: +86-755-8427 6832

Email & Skype: info@chipsmall.com Web: www.chipsmall.com

Address: A1208, Overseas Decoration Building, #122 Zhenhua RD., Futian, Shenzhen, China



PJB Open Frame Power Supply

24V 150W 1 Phase / PJB-24V150W□□A

PJB

Highlights & Features

- Universal AC Input (85Vac – 264Vac)
- Power Boost of 200% for 10 seconds
- Low Inrush Current / Low Leakage Current
- High efficiency and PF factor to conserve energy
- Conformal coating on PCBA to protect against chemical and dust pollutants
- Remote ON/OFF (Optional for 150W)
- Versatile configuration options: Open Frame, L Frame, Enclosed
- Long life capacitors

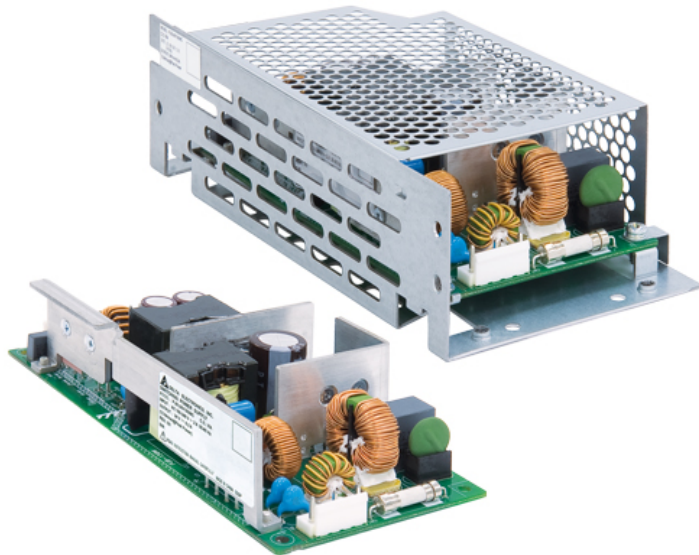

Safety Standards



CB Certified for worldwide use

- Model Number:** PJB-24V150W□□A
- Unit Weight:** 0.31 kg (Open Frame)
0.51 kg (Enclosed)
- Dimensions (L x W x D):** 160 x 75 x 37 mm (Open Frame)
188 x 85 x 47 mm (Enclosed)

General Description

The PJB series of Open Frame Power Supply comes with universal AC input at 85Vac to 264Vac. Other features include low leakage / Inrush current and conformal coating on the PCBAs to provide protection against dust and chemical pollutants. The built-in active PFC provides PF > 0.97 and fulfills Harmonic Current Emission according to IEC/EN 61000-3-2. The feature built-in Power Boost of 200% for 10 seconds enables reserve power to be always available for reliable startup of loads with high inrush current, thus eliminating the need of a more expensive power supply unit at higher power rating. Metal chassis and case cover are available as options for different installation preferences.

The PJB series is certified for EMI standards according to EN 55022 and EMS according to EN 55024. The products conform to major international safety standards according to EN/UL 60950-1 standards and are fully compliant with RoHS Directive 2011/65/EU for environmental protection.

Model Information

PJB Open Frame Power Supply

| Model Number | Input Voltage Range | Output Voltage | Output Current |
|----------------|---------------------|----------------|----------------|
| PJB-24V150W□□A | 85-264Vac | 24Vdc | 6.30A |

Model Numbering

| | | | | CC Code | |
|--------------|----------------|--------------|---|--|----------------|
| PJB – | 24V | 150W | □ | □ | A |
| PJB Series | Output Voltage | Output Power | Package Type B - Open Frame L - L Frame C - Enclosed | Remote ON/OFF Function N - No Remote ON/OFF R - With Remote ON/OFF | Delta Standard |

PJB Open Frame Power Supply

24V 150W 1 Phase / PJB-24V150W□□A

Specifications

Input Ratings / Characteristics

| | |
|-------------------------|--|
| Nominal Input Voltage | 100-240Vac |
| Input Voltage Range | 85-264Vac |
| Nominal Input Frequency | 50-60Hz |
| Input Frequency Range | 47-63Hz |
| Input Current | 1.90A typ. @ 100Vac, 0.95A typ. @ 200Vac |
| Efficiency at 100% Load | 88.0% typ. @ 100Vac, 90.5% typ. @ 200Vac |
| Max Inrush Current | 15A typ. @ 100Vac, 30A typ. @ 200Vac |
| Power Factor Correction | 0.98 typ. @ 100Vac, 0.95 typ. @ 200Vac |
| Leakage Current | 0.2mA @ 100Vac, 0.4mA @ 240Vac |

Output Ratings / Characteristics

| | |
|---|---|
| Nominal Output Voltage | 24Vdc |
| Output Voltage Tolerance | ± 1% (initial set point tolerance from factory) |
| Output Voltage Adjustment Range | 21.6-26.4Vdc |
| Output Current | 6.30A (continuously operating at 24V) 12.6A (Power Boost for 10 seconds at 24V, refer to the details in the Functions section) |
| Output Power | 151.2W (continuously operating at 24V) 302.4W (Power Boost for 10 seconds at 24V, refer to the details in the Functions section) |
| Line Regulation | < 96mV |
| Load Regulation | < 150mV |
| Ripple (20MHz) | < 150mVpp @ 0°C to 50°C, < 180mVpp @ -10°C to 0°C |
| Ripple Noise (20MHz) | < 150mVpp @ 0°C to 50°C, < 180mVpp @ -10°C to 0°C |
| Start-up Time | 500ms typ. @ 100Vac |
| Hold-up Time | 20ms typ. @ 100Vac |
| Dynamic Response (Overshoot & Undershoot O/P Voltage) | ± 5% @ 0-50% load and 50-100% load (Slew Rate: 0.1A/μS) |
| Start-up with Capacitive Loads | 8,000μF Max |

Mechanical

| | |
|----------------|---|
| Case Chassis | SGCC |
| Case Cover | SGCC |
| Dimensions | 160 x75 x 37 mm (Open Frame) 188 x 85 x 47 mm (Enclosed) |
| Unit Weight | 0.31 kg (Open Frame) 0.51 kg (Enclosed) |
| Indicator | NA |
| Cooling System | Convection |
| Terminal | Input JST B3P5-VH (LF)(SN) Output V-: JST B7P-VH (LF)(SN), V+: JST B6P-VH (LF)(SN) |
| Wire | AWG 22-18 |

PJB Open Frame Power Supply

24V 150W 1 Phase / PJB-24V150W□□A

Environment

| | | |
|-----------------------------|------------------------|--|
| Surrounding Air Temperature | Operating | -10°C to +70°C |
| | Storage | -25°C to +75°C |
| Power De-rating | Mounting Orientation A | > 50°C de-rate power by 2% / °C < 90Vac de-rate power by 2% / V |
| Operating Humidity | | 5 to 95% RH (Non-Condensing) |
| Operating Altitude | | 0 to 5,000 Meters |
| Shock Test (Non-Operating) | | IEC 60068-2-27, Half Sine Wave: 50G for a duration of 11ms, 3 shocks for each 3 directions |
| Vibration (Operating) | | IEC 60068-2-6, Sine Wave: 10Hz to 55Hz @ 19.6m/S ² (2G peak); 10 min per cycle, 60 min per axis for all X, Y, Z direction |

Protections

| | |
|--------------------------|---|
| Overvoltage | 27.6-33.6V, Latch Mode |
| Overload / Overcurrent | > 220% of rated load current, Hiccup Mode, Non-Latching (Auto-Recovery) |
| Over Temperature | Latch Mode |
| Short Circuit | Hiccup Mode, Non-Latching (Auto-Recovery when the fault is removed) |
| Protection Against Shock | Class I with PE* connection |

*PE: Primary Earth

Reliability Data

| | |
|------------------------|---------------------------------------|
| MTBF | > 200,000 hrs. as per JEITA RCR-9102B |
| Expected Cap Life Time | 10 years (115Vac, 50% load @ 40°C) |

Safety Standards / Directives

| | | |
|--------------------|---|---------|
| Electrical Safety | TUV Bauart to EN 60950-1, UL/cUL recognized to UL 60950-1 and CSA C22.2 No. 60950-1, CB scheme to IEC 60950-1 | |
| ITE | IEC 60950-1 | |
| CE | In conformance with EMC Directive 2004/108/EC and Low Voltage Directive 2006/95/EC | |
| Material and Parts | RoHS Directive 2011/65/EU Compliant | |
| Galvanic Isolation | Input to Output | 3.0KVac |
| | Input to Ground | 2.0KVac |
| | Output to Ground | 0.5KVac |

PJB Open Frame Power Supply

24V 150W 1 Phase / PJB-24V150W□□A

EMC

| | | |
|-----------------------------------|----------------|--|
| EMC / Emissions | | CISPR22, EN 55022, FCC Title 47: Class B |
| Immunity to | | |
| Electrostatic Discharge | IEC 61000-4-2 | Criteria A ¹⁾ Air Discharge: 8kV (Level 3) Contact Discharge: 4kV (Level 2) |
| Radiated Field | IEC 61000-4-3 | Level 2 Criteria A ¹⁾ 80MHz-1GHz, 3V/M with 1kHz tone / 80% modulation |
| Electrical Fast Transient / Burst | IEC 61000-4-4 | Level 2 Criteria A ¹⁾ 1kV |
| Surge | IEC 61000-4-5 | Level 3 Criteria A ¹⁾ Common Mode ²⁾ : 2kV Differential Mode ³⁾ : 1kV |
| Conducted | IEC 61000-4-6 | Level 2 Criteria A ¹⁾ 150kHz-80MHz, 3Vrms |
| Power Frequency Magnetic Fields | IEC 61000-4-8 | Criteria A ¹⁾ Magnetic field strength 1A/Meter |
| Voltage Dips | IEC 61000-4-11 | 100% dip; 1 cycle (20ms); Self Recoverable |
| Harmonic Current Emission | | IEC/EN 61000-3-2, Class A |
| Voltage Fluctuation and Flicker | | IEC/EN 61000-3-3 |

1) Criteria A: Normal performance within the specification limits

2) Asymmetrical: Common mode (Line to earth)

3) Symmetrical: Differential mode (Line to line)

Block Diagram

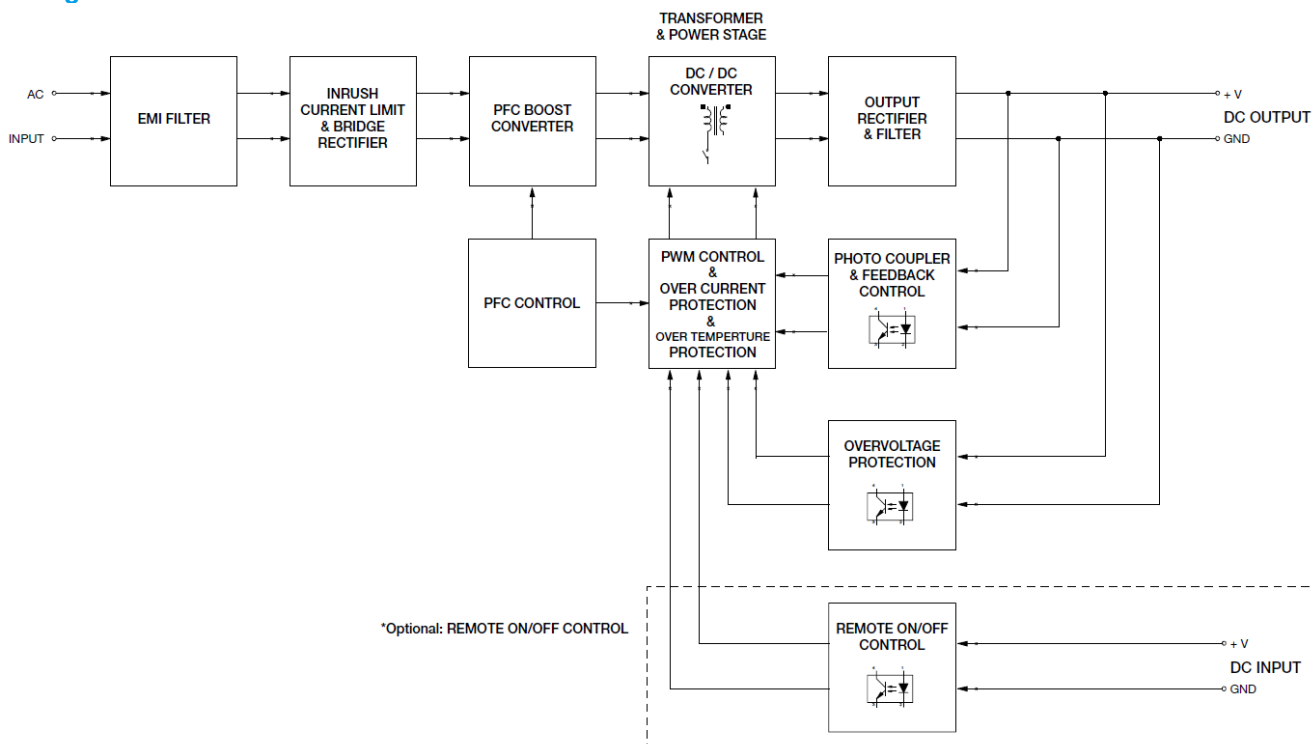

PJB Open Frame Power Supply

24V 150W 1 Phase / PJB-24V150W□□A

Dimensions

L x W x D: 160 x 75 x 37 mm (Open Frame)

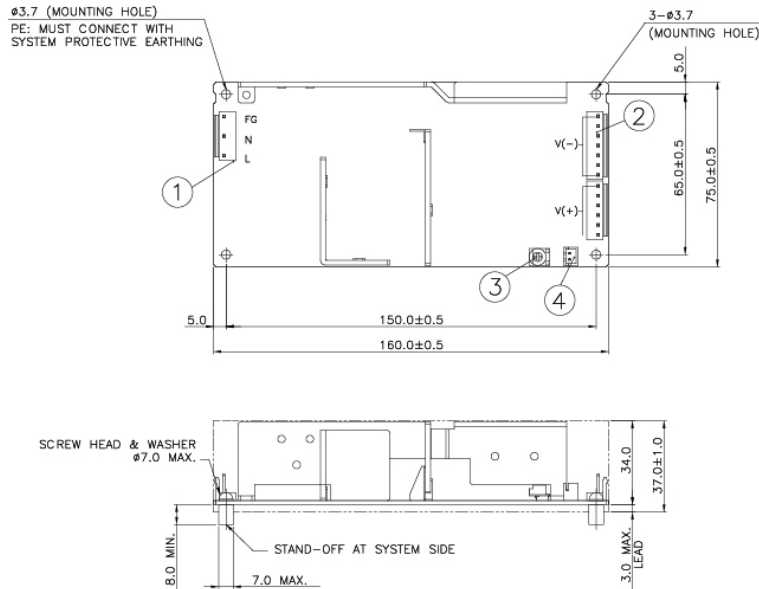

L x W x D: 188 x 85 x 47 mm (L Frame)

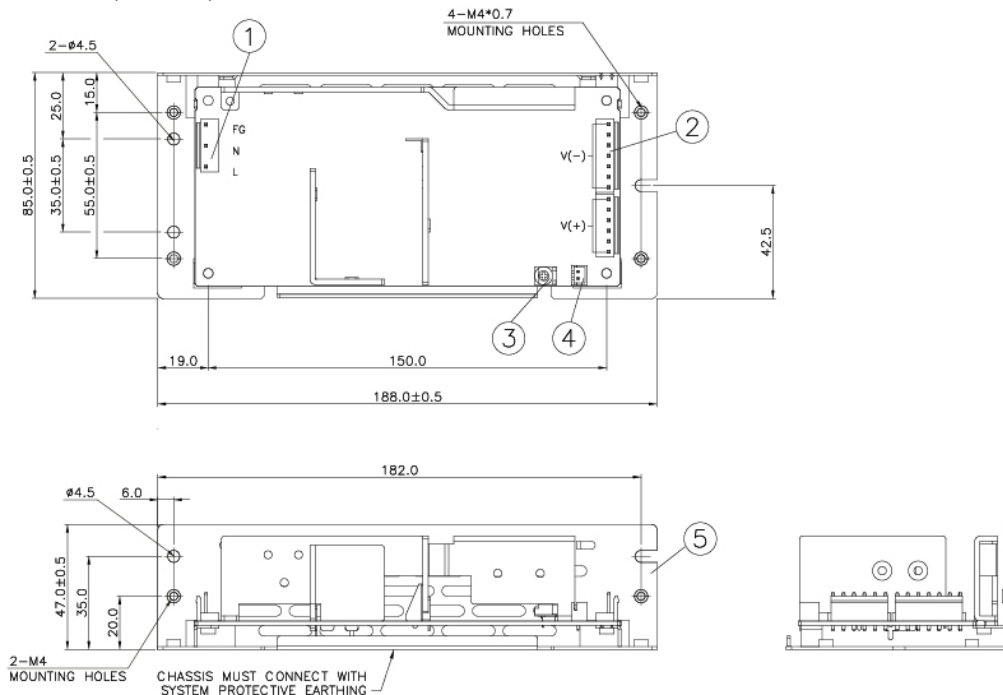

| Item | Device Description |
|------|------------------------------|
| 1 | Input Connector |
| 2 | Output Connector |
| 3 | VR |
| 4 | Remote ON/OFF (JST B2B-XH-A) |
| 5 | Chassis |

Notes

- Dimensions are in mm
- For information on Mounting Torque, and I/O Connector and Housing, please refer to the Instruction Manual.
- For L Frame type: There are 6 threaded mounting holes and 5 normal mounting holes.
- For Open Frame type: There are 4 normal mounting holes.

PJB Open Frame Power Supply

24V 150W 1 Phase / PJB-24V150W□□A

L x W x D: 188 x 85 x 47 mm (Enclosed)

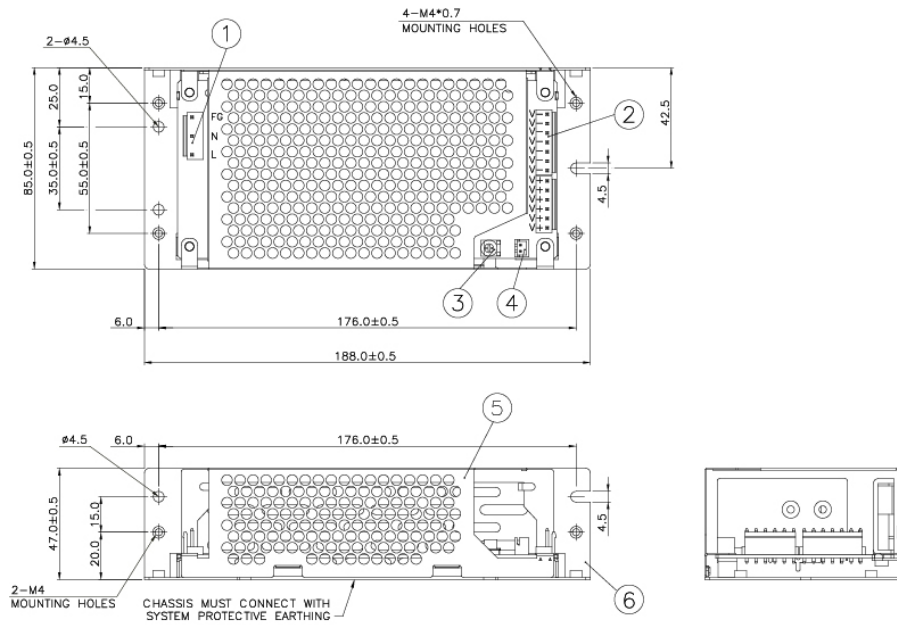

| Item | Device Description |
|------|------------------------------|
| 1 | Input Connector |
| 2 | Output Connector |
| 3 | VR |
| 4 | Remote ON/OFF (JST B2B-XH-A) |
| 5 | Cover |
| 6 | Chassis |

Notes

- Dimensions are in mm
- For information on Mounting Torque, and I/O Connector and Housing, please refer to the Instruction Manual.
- For Enclosed type: There are 6 threaded mounting holes and 5 normal mounting holes.

PJB Open Frame Power Supply

24V 150W 1 Phase / PJB-24V150W□□A

Assembly & Installation

Assembly Reference

■ Open Frame

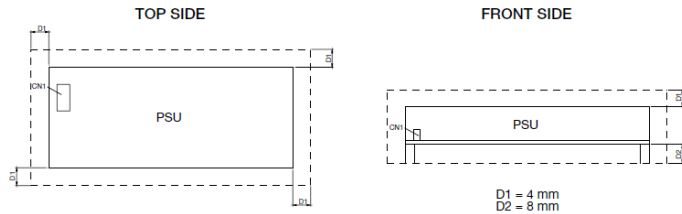

■ L Frame / Enclosed

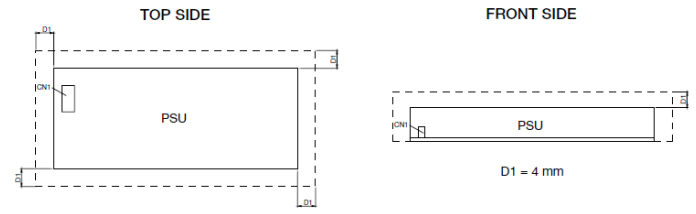

For safety reasons, please ensure the mounted device is kept at $\geq 4\text{mm}$ safety distance at all sides from other components and equipments. **Please insert an insulation sheet between the system and product, if the safety distance is less than 4mm.**

- Use flexible cable (stranded or solid) of AWG No. 22-18. Please refer to Table 1 for the recommended Housing and Terminal.
- For the Remote ON/OFF function, use flexible cable (stranded or solid) of AWG No. 28-22.

| Table 1 | Connector (Board Mounting) | Housing | Terminal |
|---------------------------------|----------------------------|---------|---------------|
| Input (JST) | B3P5-VH(LF)(SN) | VHR-5N | SVH-21T-P1.1 |
| Output (JST) | B8P-VH(LF)(SN) | VHR-8N | |
| Remote ON/OFF Function (Option) | B2B-XH-A(LF)(SN) | XHP-2 | SXH-001T-P0.6 |

PJB Open Frame Power Supply

24V 150W 1 Phase / PJB-24V150W□□A

Mounting Orientation

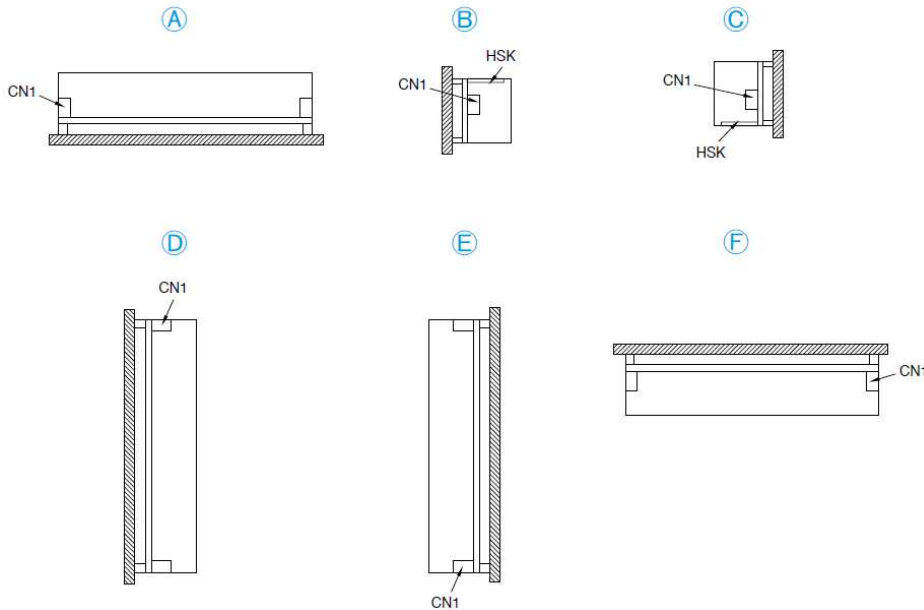

- Any excessive twisting or bending may damage the device's PCB. Please handle the device with care.
- The device is not recommended to be placed on low thermal conductive surfaces. For example, plastics.
- Prevent any foreign metal, particles or conductors from entering the device through the openings during installation. It may cause: -Electric shock; Safety hazard; Product failure.
- **The power supply must be mounted by metal screws onto a grounded metal surface. It is highly recommended that the Earth terminal on the connector be connected to the grounded metal surface.**

Engineering Data

Convection

■ Open Frame / L Frame

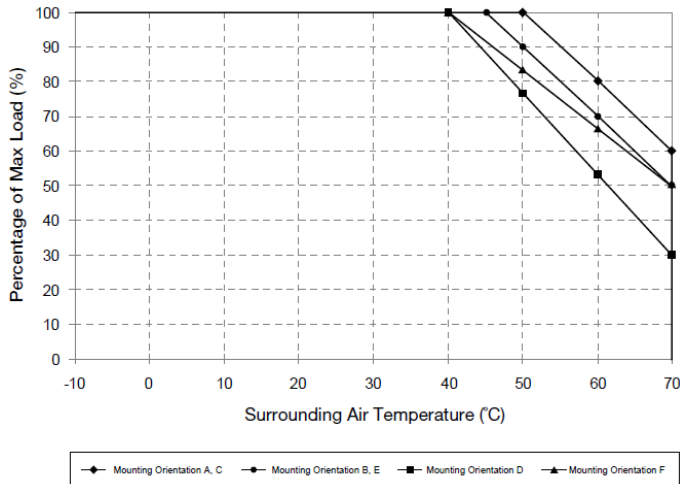

■ Enclosed

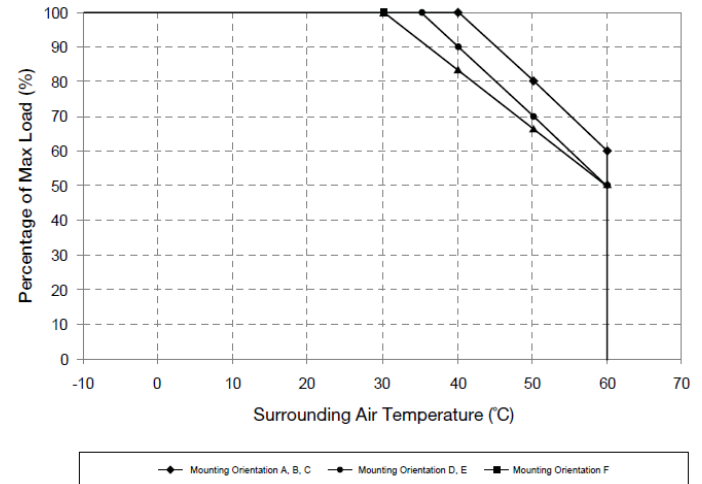

Fig.1.1 De-rating for Mounting Orientation A, C
 > 50°C de-rate power by 2% / °C
 De-rating for Mounting Orientation B, E
 > 45°C de-rate power by 2% / °C
 De-rating for Mounting Orientation D
 > 40°C de-rate power by 2.33% / °C
 De-rating for Mounting Orientation F
 > 40°C de-rate power by 1.66% / °C

Fig.1.2 De-rating for Mounting Orientation A, B, C
 > 40°C de-rate power by 2% / °C
 De-rating for Mounting Orientation D, E
 > 30°C de-rate power by 1.66% / °C
 De-rating for Mounting Orientation F
 > 35°C de-rate power by 2% / °C

PJB Open Frame Power Supply

24V 150W 1 Phase / PJB-24V150W□□A

Forced Cooling (Air Velocity > 0.7m/s)

■ Air Flow Direction

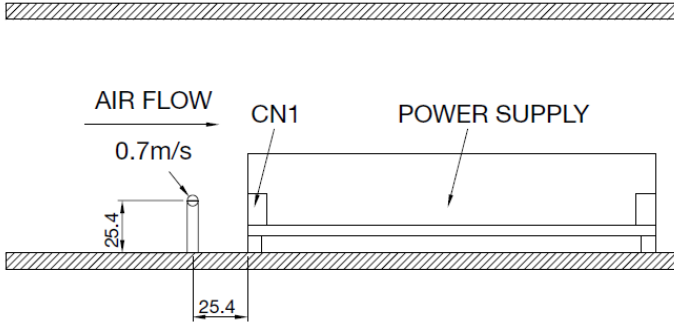

■ Open Frame / L Frame

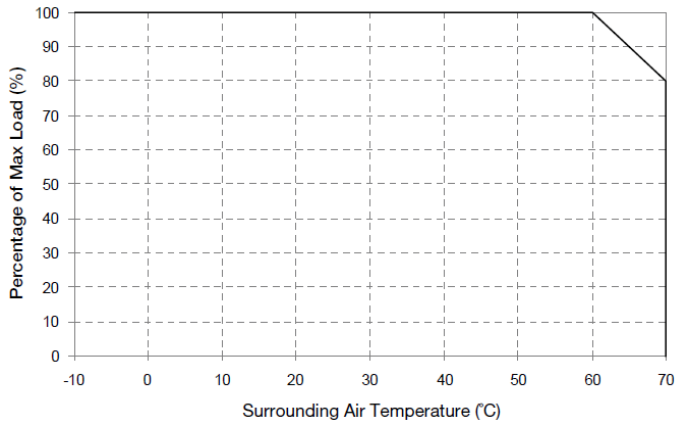

Fig.1.3 De-rating for Mounting Orientation A to F
> 60°C de-rate power by 2% / °C

■ Enclosed

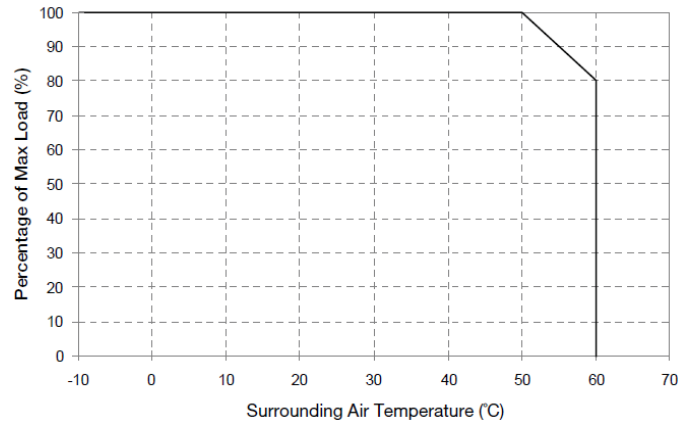

Fig.1.4 De-rating for Mounting Orientation A to F
> 50°C de-rate power by 2% / °C

Notes

1. Power supply components may degrade, or be damaged, when the power supply is continuously used outside the shaded region, refer to the graphs shown above.
2. If the output capacity is not reduced when the surrounding air temperature is more than the upper limit temperature, the device will run into Over Temperature Protection. When activated, the output voltage will go into bouncing mode and will recover when the surrounding air temperature is lowered or the load is reduced as far as necessary to keep the device in working condition.
3. Depending on the surrounding air temperature and output load delivered by the power supply, the device housing can be very hot!
4. If the device has to be mounted in any other orientation, please do not hesitate to contact info@deltapsu.com for more details.

PJB Open Frame Power Supply

24V 150W 1 Phase / PJB-24V150W□□A

Output De-rating VS. Input Voltage

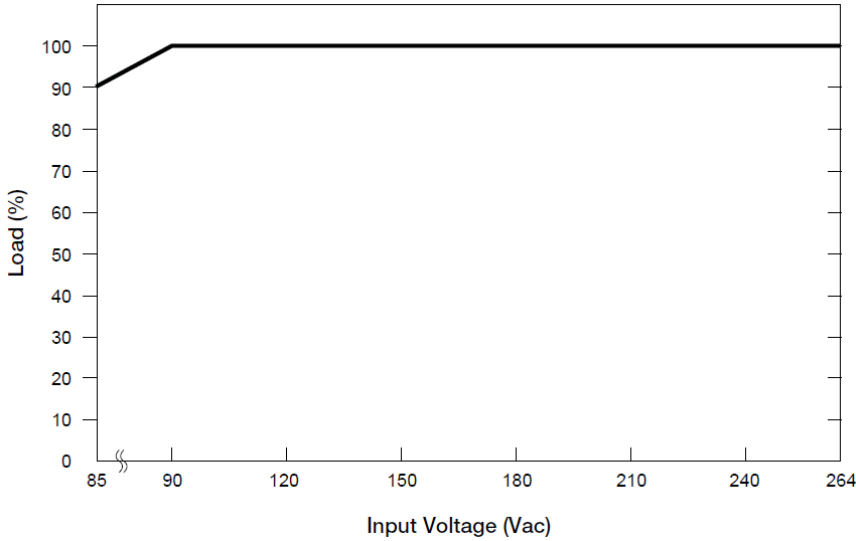

■ No output power de-rating for the input voltage range from 90Vac to 264Vac

Functional Manual

Remote ON/OFF Function

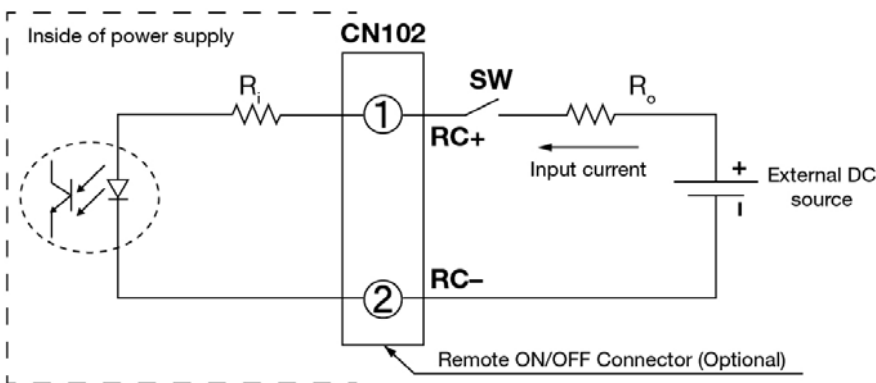

You can remotely control the power supply unit to turn ON/OFF by using an external DC source. Follow the DC power source voltage and current limiting defined in the table below.

| Built-in Resistor R _i (ohm) | Voltage Between RC+ and RC- (V) | | Input Current (mA) |
|--|---------------------------------|------------|--------------------|
| | Output ON | Output OFF | |
| 1k | 5-12.5 | 0-0.5 | 20 Max |

Notes

1. Remote ON/OFF circuits are isolated from input, output and PE.
2. Please check if the polarity of the wire connector is the same as the external DC source. If not, the power would not turn on and the internal components may be damaged.
3. You do not need an external resistance R_o for current limit while the output voltage of external DC source is within the range of 5-12.5V. If the output voltage exceeds 12.5V, please use the following equation for the value of current limit resistance R_o.

$$R_o = \frac{V_{cc} - (3.5 + 0.006R_i)}{0.006}$$

PJB Open Frame Power Supply

24V 150W 1 Phase / PJB-24V150W□□A

Functions

Start-up Time

The time required for the output voltage to reach 90% of its set value, after the input voltage is applied.

Rise Time

The time required for the output voltage to change from 10% to 90% of its set value.

Hold-up Time

Hold up time is the time when the AC input collapses and output voltage retains regulation for a certain period of time. The time required for the output to reach 95% of its set value, after the input voltage is removed.

■ Graph illustrating the Start-up Time, Rise Time, and Hold-up Time

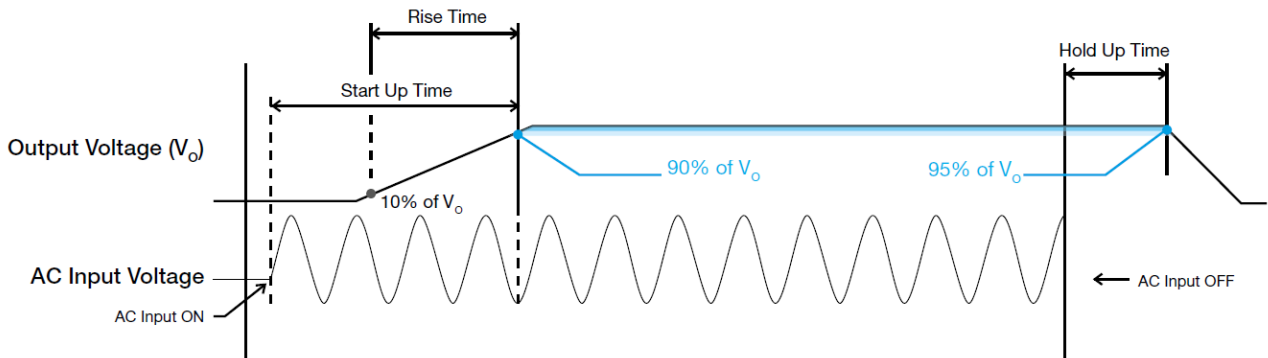

Dynamic Response

The power supply output voltage will remain within $\pm 5\%$ of its steady state value, when subjected to a dynamic load from 0 to 50% and 50 to 100% of its rated current.

■ 0 to 50% Load

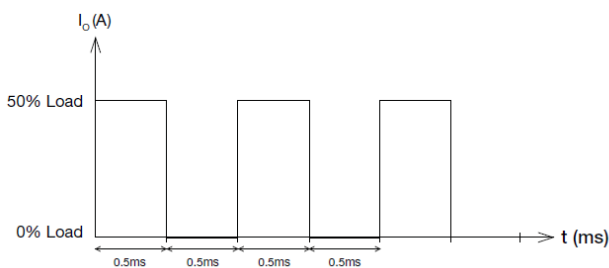

■ 50 to 100% Load

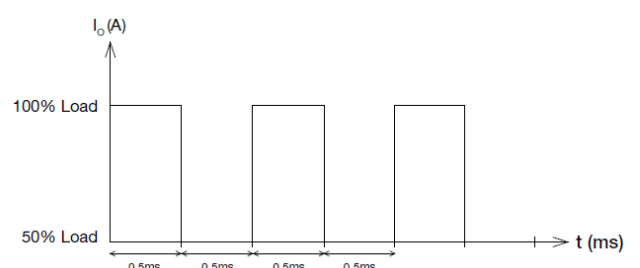

PJB Open Frame Power Supply

24V 150W 1 Phase / PJB-24V150W□□A

Power Boost

Power Boost is the reserve power available constantly that allows reliable startup to support sudden and short spike of loads with high inrush current typically during turn on to remove the need of more expensive higher rated power supply unit. After the output has reached its steady state set value, the power supply can support surge loads with a higher short-term power demand up to 200% of maximum rated load (I_o Max), for a maximum duration of 10 seconds. The Power Boost is also available to repeatedly basis with according to the condition of an average (R.M.S) output power shall not exceed continuous operating condition or refer to duty cycle calculation below.

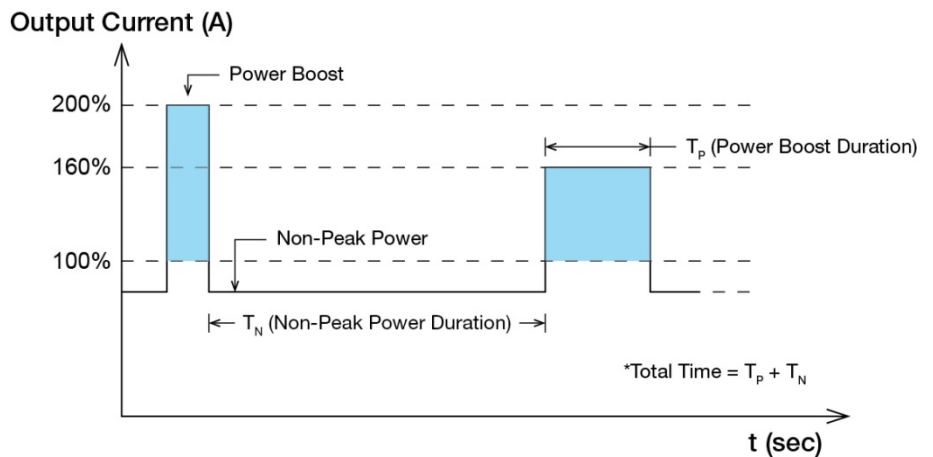

$$Duty\ cycle\ (\%) = \frac{T_P}{Total\ Time} ; (T_P \leq 10\ sec)$$

$$Average\ Output\ Power\ (P_{Avg}) = \frac{(Power\ Boost \times T_P) + (Non-Peak\ Power \times T_N)}{Total\ Time}$$

OR

$$Non-Peak\ Power = \frac{(P_{Avg} \times Total\ Time) - (Power\ Boost \times T_P)}{T_N}$$

■ An example of Power Boost and Average Output Power

| Power Boost | Peak Power (W _P) | Power Boost Duration (T _P) | Duty Cycle | Non-Peak Power (W _N) | Non-Peak Power Duration (T _N) | Total Time (T) |
|-------------|------------------------------|--|------------|----------------------------------|---|----------------|
| 200% | 302.4W | 10 sec | 15% | 124.52W | 56.67 sec | 66.67 sec |
| 200% | 302.4W | 5 sec | 15% | 124.52W | 28.33 sec | 33.33 sec |
| 160% | 240W | 10 sec | 40% | 92W | 15 sec | 25 sec |
| 160% | 240W | 5 sec | 40% | 92W | 7.5 sec | 12.5 sec |

It is not recommended to prolong the duration of Power Boost to be longer than the specified duty cycle calculation, this may cause damage to the PSU.

PJB Open Frame Power Supply

24V 150W 1 Phase / PJB-24V150W□□A

Inrush Current

Inrush current is the peak, instantaneous, input current measured and, occurs when the input voltage is first applied. For AC input voltages, the maximum peak value of inrush current will occur during the first half cycle of the applied AC voltage. This peak value decreases exponentially during subsequent cycles of AC voltage.

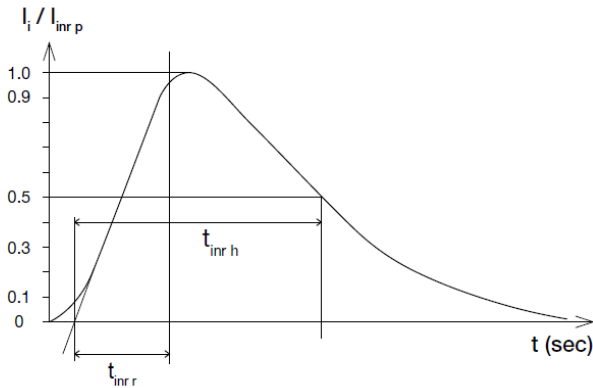

Overvoltage Protection

The power supply's overvoltage circuit will be activated when its internal feedback circuit fails. The output voltage shall not exceed its specifications defined on Page 3 under "Protections".

The power supply should be latch.

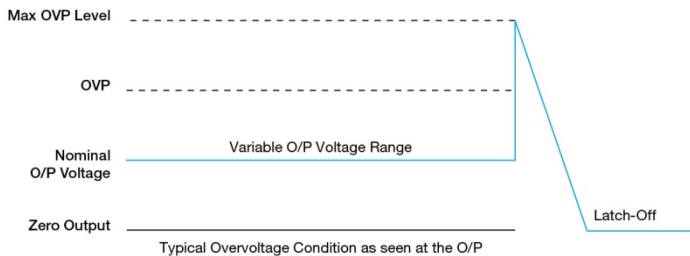

Overload & Overcurrent Protections

The power supply's Overload (OLP) and Overcurrent (OCP) Protections will be activated when output current exceeds 220% of I_O (Max load). In such occurrence, the V_O will start to droop and once the power supply has reached its maximum power limit, the protection is activated and the power supply will go into "Hiccup mode" (Auto-Recovery). The power supply will recover once the fault condition of the OLP and OCP is removed and I_O is back within the specifications.

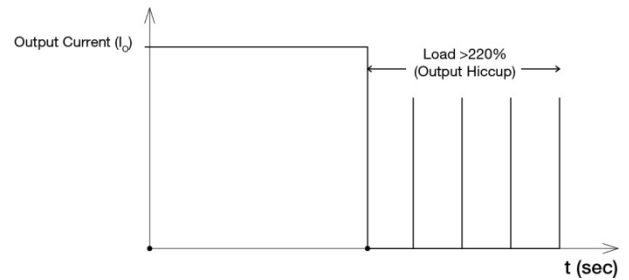

It is not recommended to prolong the duration of I_O when it is $<220\%$ but $>100\%$, since it may cause damage to the PSU.

Over Temperature Protection

As mentioned above, the power supply also has Over Temperature Protection (OTP). In the event of a higher operating temperature at 100% load, the power supply will run into OTP when the operating temperature is beyond what is recommended in the de-rating graph. When activated, the output voltage will go into latch mode until the mains is reapplied and the temperature drops to its normal operating temperature as recommended in the de-rating graph.

Short Circuit Protection

The power supply's output OLP/OCP function also provides protection against short circuits. When a short circuit is applied, the output current will operate in "Hiccup mode", as shown in the illustration in the OLP/OCP section on this page. The power supply will return to normal operation after the short circuit is removed.

PJB Open Frame Power Supply

24V 150W 1 Phase / PJB-24V150W□□A

Others

Delta RoHS Compliant



Restriction of the usage of hazardous substances

The European directive 2011/65/EU limits the maximum impurity level of homogeneous materials such as lead, mercury, cadmium, chrome, polybrominated flame retardants PBB and PBDE for the use in electrical and electronic equipment. RoHS is the abbreviation for “Restriction of the use of certain hazardous substances in electrical and electronic equipment”.

This product conforms to this standard.

Conformal Coating

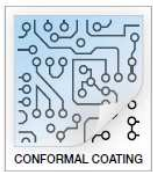

The Protective Coating Technology

Delta Electronics Group has designed the perfect dipping technique which penetrates everywhere including under device, and prevents leakage. The conformal coating dipping can be applied to PCBs or circuit board. The coating preserves the performance of precision electronic primarily by preventing ionizable contaminants such as salt from reaching circuit nodes, where the material slumps around sharp edges. This can be a problem especially in highly conversing atmosphere.

PFC – Norm EN 61000-3-2

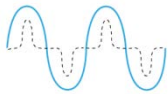

Line Current Harmonic content

Typically, the input current waveform is not sinusoidal due to the periodical peak charging of the input capacitor. In industrial environment, complying with EN 61000-3-2 is only necessary under special conditions. Complying to this standard can have some technical drawbacks, such as lower efficiency as well as some commercial aspects such as higher purchasing costs. Frequently, the user does not profit from fulfilling this standard, therefore, it is important to know whether it is mandatory to meet this standard for a specific application.