



Chipsmall Limited consists of a professional team with an average of over 10 year of expertise in the distribution of electronic components. Based in Hongkong, we have already established firm and mutual-benefit business relationships with customers from,Europe,America and south Asia,supplying obsolete and hard-to-find components to meet their specific needs.

With the principle of “Quality Parts,Customers Priority,Honest Operation,and Considerate Service”,our business mainly focus on the distribution of electronic components. Line cards we deal with include Microchip,ALPS,ROHM,Xilinx,Pulse,ON,Everlight and Freescale. Main products comprise IC,Modules,Potentiometer,IC Socket,Relay,Connector.Our parts cover such applications as commercial,industrial, and automotives areas.

We are looking forward to setting up business relationship with you and hope to provide you with the best service and solution. Let us make a better world for our industry!



## Contact us

Tel: +86-755-8981 8866 Fax: +86-755-8427 6832

Email & Skype: info@chipsmall.com Web: www.chipsmall.com

Address: A1208, Overseas Decoration Building, #122 Zhenhua RD., Futian, Shenzhen, China





MALLORY SONALERT PRODUCTS, INC.

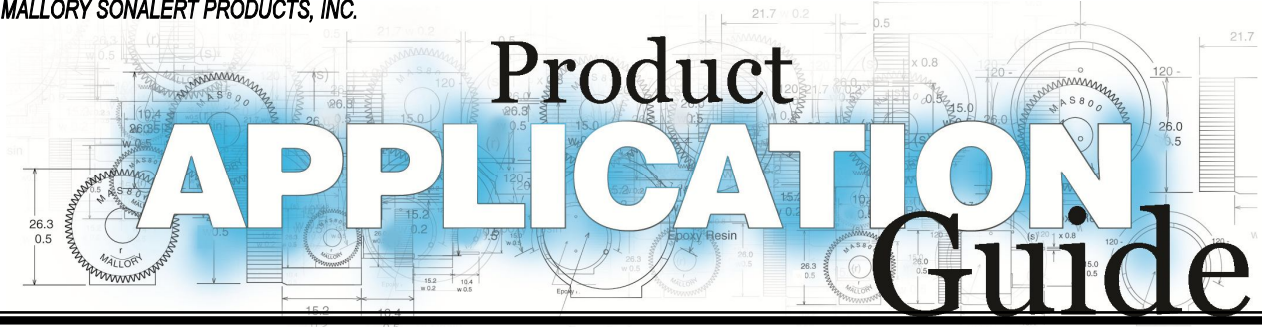

# Product APPLICATION Guide

## Product Application Guide- Indicators- Piezo

### Part Numbering System SBM Series

Part Number Structure

SBM 616 J R

Series

SBM = Large Board Mount

Voltage Range & Type

1 = 1 to 5 Vdc

616 = 6 to 16 Vdc

628 = 6 to 28 Vdc

Suffixes

J = Slow Pulse

JU = Dual Mode P = Fast Pulse

PU = Dual Mode

RoHS: R = RoHS Compliant

## Part Numbering System MSR MSO Series

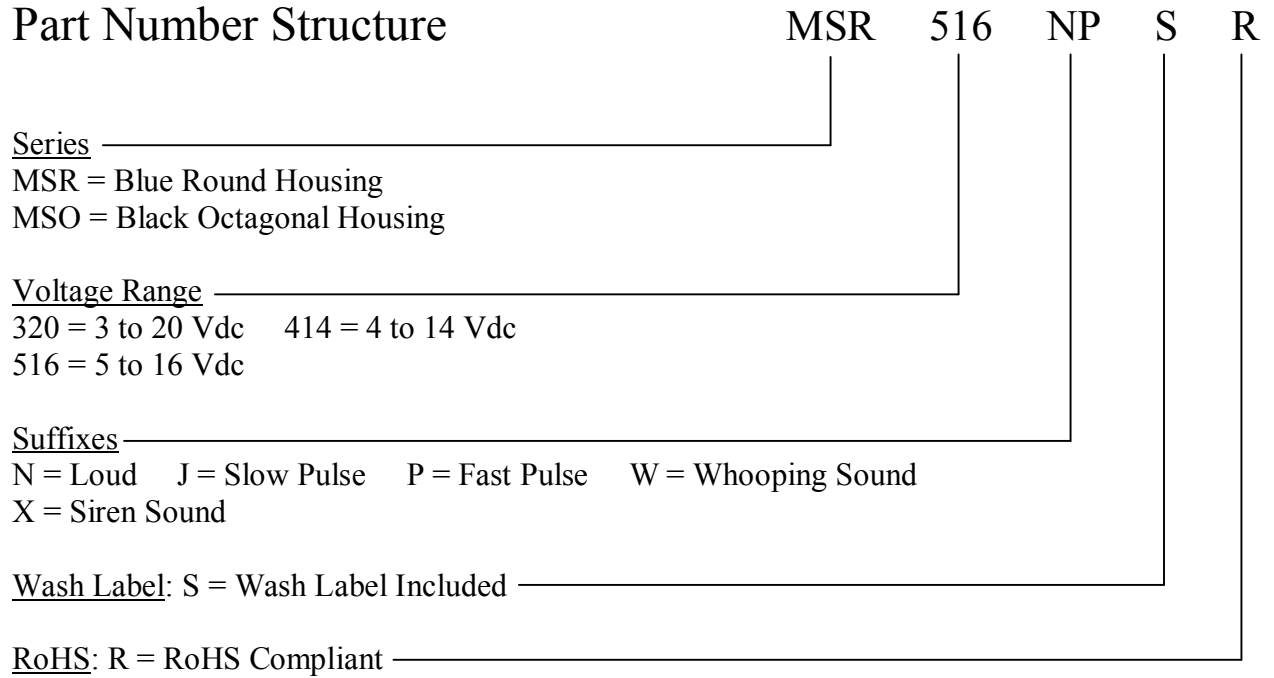

## Part Numbering System Indicator Series (PK PF PFD PL PLD ASI)

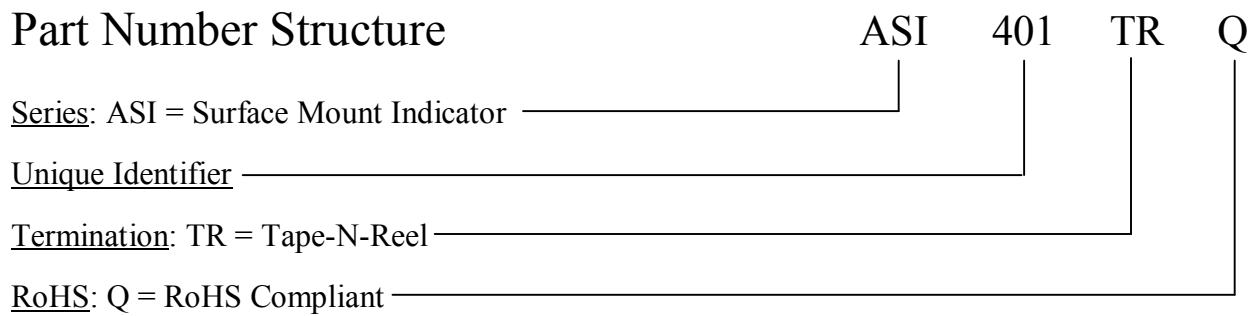
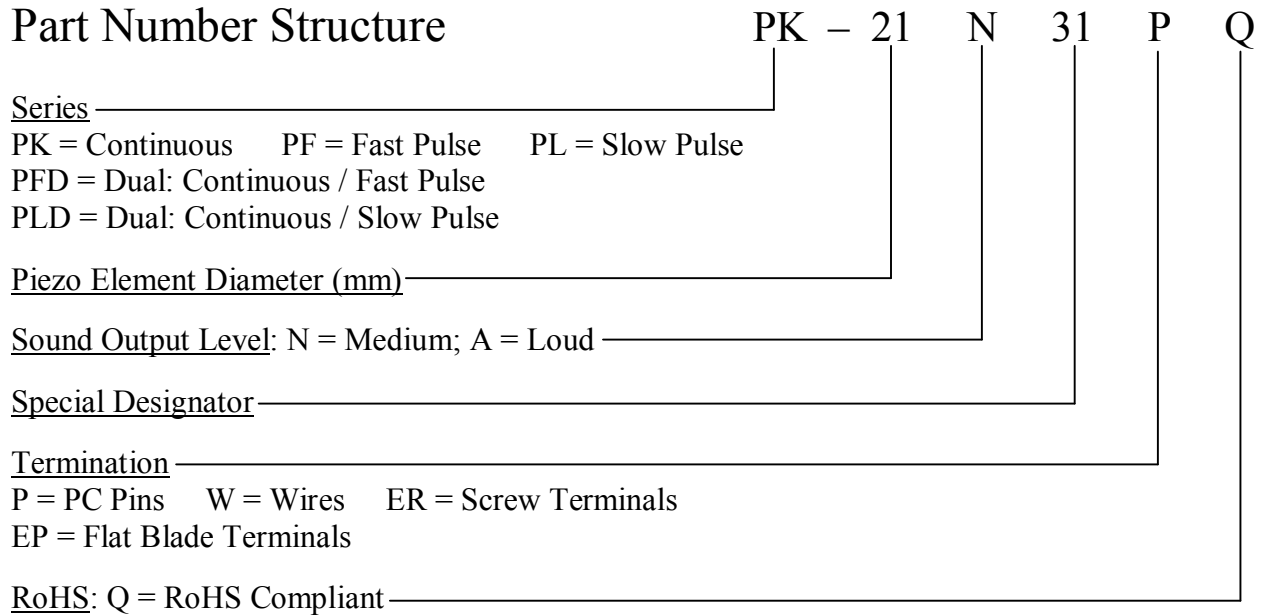

## Piezoelectric Electronic Alarm Construction

Piezoelectric Audible Signal Basic Construction

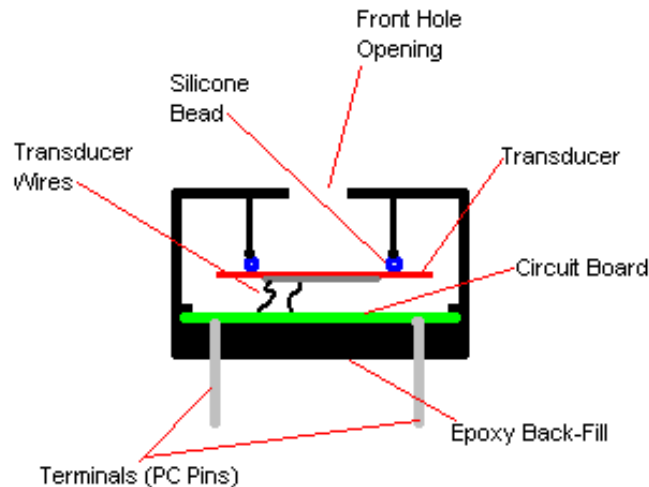

The above cross section picture shows the basic elements used in a piezoelectric audible alarm. The area in front of the transducer element including the front hole opening forms an acoustic cavity that lets the sound radiate out with the most efficiency (i.e. loudest sound level). If the alarm is an indicator that contains a circuit board, the circuit board is attached to the piezoelectric sounder element via soldered wires.

The above picture can be interpreted to represent a board mount package with pc pin terminations, but the same concept is used when building audible alarms in other mounting configurations such as SMT, Flange Mount, and Panel Mount alarms.

If the back of the alarm is sealed with epoxy or other material, the “guts” of the alarm (including the circuit board and components) are protected against fluid intrusion. However, fluid sitting inside the front cavity can obstruct the operation of the device causing the sound level to decrease significantly. If you need to wash the alarms after a soldering operation, it is strongly recommended to use an alarm that comes with a wash label that keeps the washing fluid from getting inside of the front cavity.

## Operation of Piezoelectric Audible Alarms

Piezoelectric electronic audible alarms work by converting the user input voltage to an appropriate oscillating signal that is applied to a sounder element that is mounted in a housing. The piezoelectric sounder element consists of a metal disc that has a special ceramic material bonded to it that physically bends when voltage is applied to it.

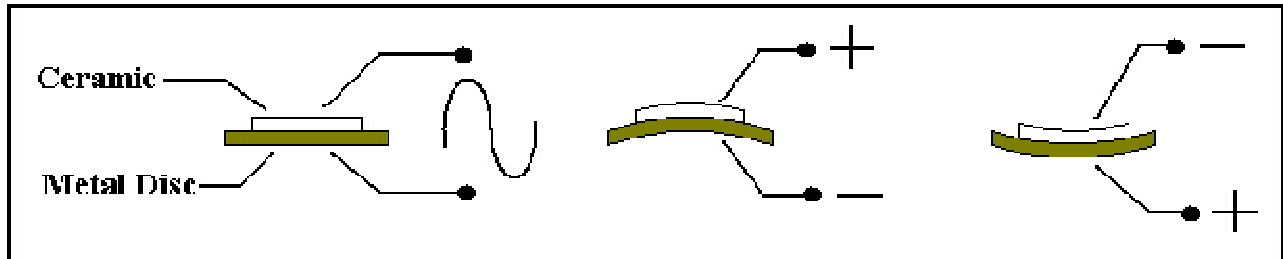

The above picture shows a bare piezoelectric sounder element. By applying a sinusoidal wave-form at an appropriate frequency, the transducer will physically deflect in one direction and then in the opposite direction following the shape of the input wave-form. If this oscillation occurs in the audible frequency range (1 Hz to 20 kHz), then air pressure waves are produced that the human ear interprets as an audible sound.

The larger the voltage of the applied wave-form, the larger the amplitude of the air pressure waves resulting in a louder sound level. However, the ceramic portion of the transducer can only bend so far before there is a risk of a catastrophic failure. This maximum voltage is somewhere around 40 to 50 volts. However, it is rare to apply this much voltage to a transducer as you reach a point of diminishing returns for voltages much greater than 32 volts.

By itself, the sound level produced by a transducer element is insignificant. To increase the size of the air pressure waves (and thus the sound level), the transducer element must be mounted inside an acoustic chamber that is optimized for the transducer size and resonant frequency. Every transducer has one frequency where it flexes more efficiently producing the louder sound levels. This frequency where the transducer performs the best is called the resonant frequency.

Self-Drive type devices provide a 3<sup>rd</sup> terminal that connects to an isolated portion of the piezoelectric transducer. This third terminal provides a feed-back signal that is 180 degrees out of phase with the drive signal. This signal can be fed back into the circuit to allow the sounder element to self-tune itself to the transducer's resonant frequency.

## Decibel Sound Level Scale

The decibel sound level scale is an arbitrary scale that ranges from 0 dB (threshold of hearing) to 130 dB (threshold of pain). The chart below shows where some common sounds fall on this dB scale. Audible alarms are available that have sound levels as soft as 55 dB at 2 feet and as loud as 110 dB at 2 feet.

### Reference Sound Levels

(as if you were standing 2 feet from the sound source)

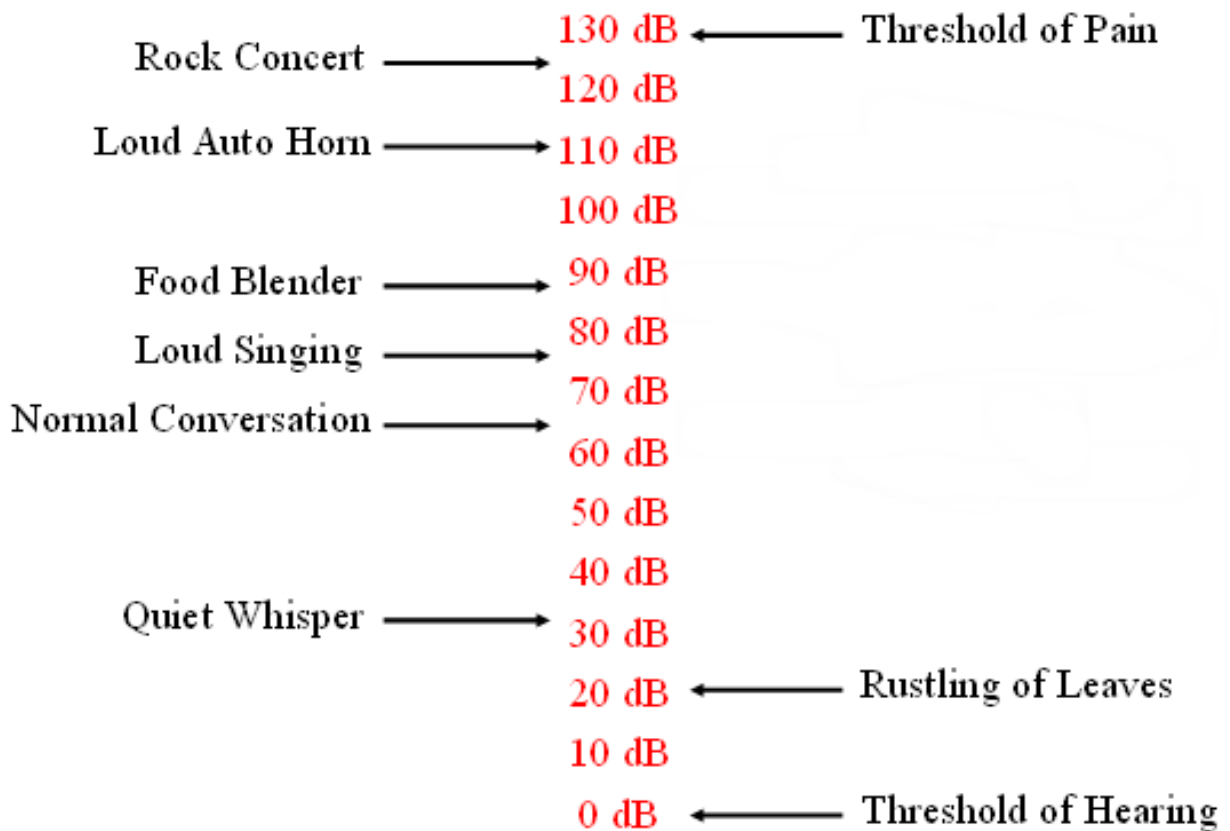

## Fundamental Frequency & Harmonics

Below is a frequency scan of a piezoelectric audible alarm that has a resonant frequency of 2,800 Hz. As you can see, there is a strong frequency peak at 2.8 kHz and several smaller frequency peaks that follow called harmonic frequencies. The table below the chart shows that the size of the harmonic frequencies are significantly smaller than the fundamental frequency for this particular alarm unit. Because this alarm has a large fundamental frequency and much smaller harmonic frequencies, the sound quality of this part will be very good. When this alarm is activated, the listener will hear one clear frequency (also called sound pitch) from the alarm. Other electronic alarm technologies such as electro-magnetic or electro-mechanical type alarms often have much larger harmonic frequency components resulting in less clear tone.

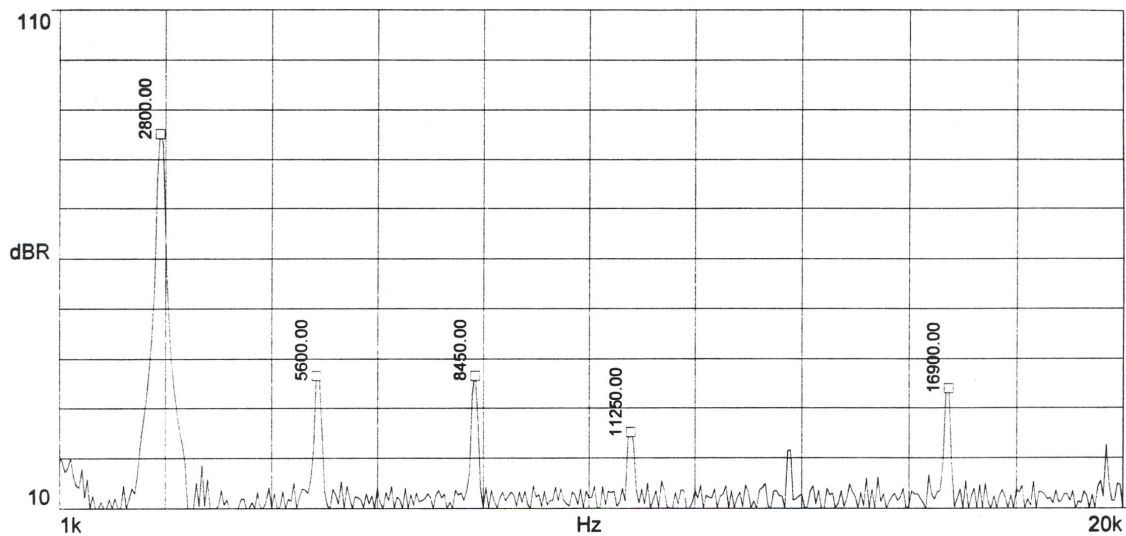

	Frequency	dB	% dB of Fundamental
Fundamental:	2.800 KHz	86.1	100.0%
2nd Harmonic:	5.600 KHz	37.6	43.7%
3rd Harmonic:	8.450 KHz	37.6	43.7%
4th Harmonic:	11.250 KHz	26.1	30.3%



## Circuit to Increase Turn-On Voltage

Below is a circuit that can be used to prevent the alarm from sounding until a certain voltage is reached. This particular circuit has a turn-on voltage around 10 Vdc due to the 10 volt Zener Diode, but you can just substitute other values of Zener Diodes to get the needed turn-on voltage for your circuit.

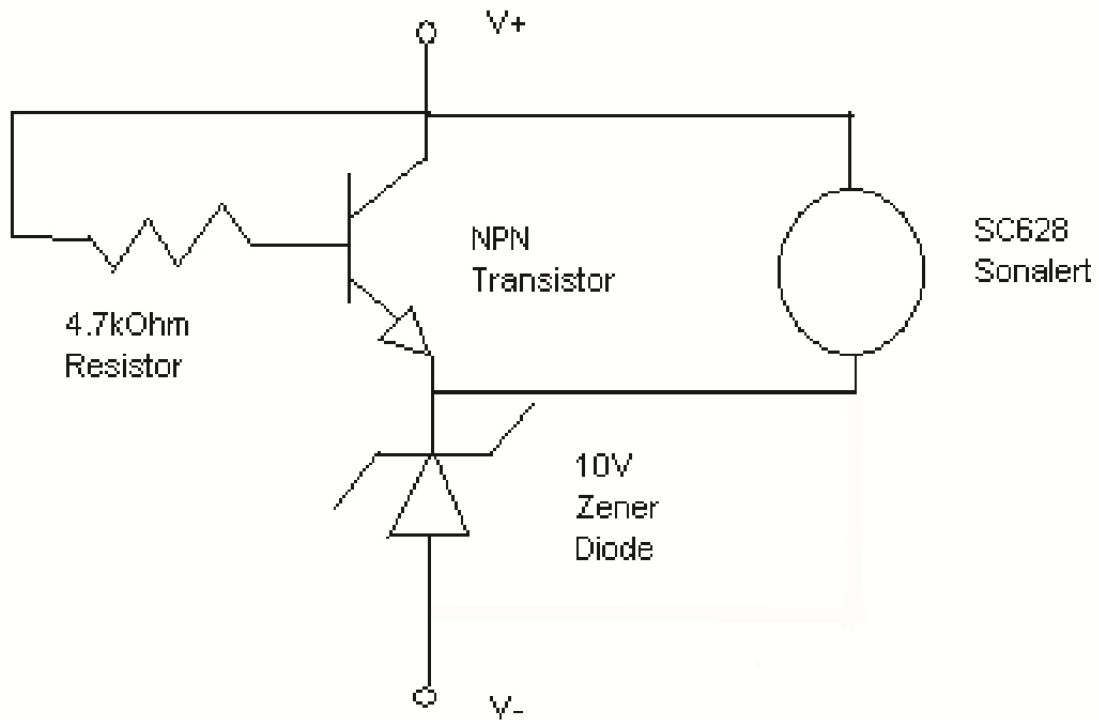

## Controlling Sound Level- Electronic Method

For piezoelectric type audible alarms, the larger the voltage signal applied to the piezoelectric transducer, the louder the sound level. This property can be used to electronically control the sound level of these devices.

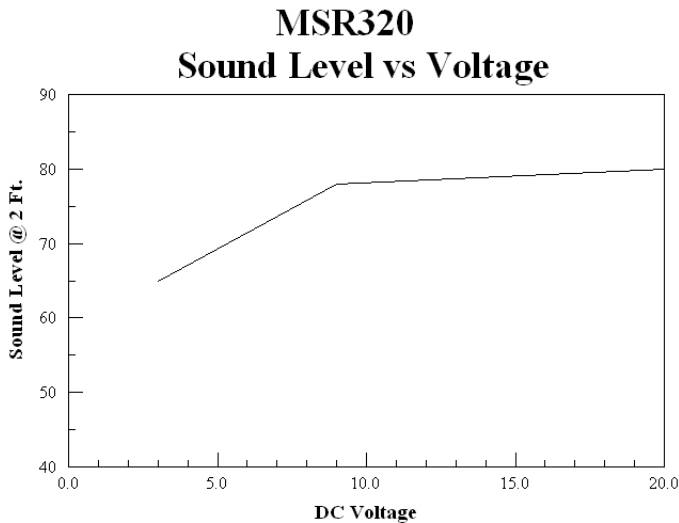

For audible alarm model MSR320R, the sound level will vary from 65 dB at 2 ft. at 3 Vdc up to 80 dB at 2 ft. at 20 Vdc. By varying the voltage from 3 to 20 Vdc, the sound level can be varied by 15 dB. A 10 dB drop in sound level will make the alarm sound half as loud.

There are several ways of electronically controlling the voltage including:

1. Using a manual or digital potentiometer.
2. Using a selector circuit and different values of resistors.
3. Using PWM voltage signals from microcontrollers.

In all cases, care must be taken to make sure that the circuitry and voltage signals used do not interfere with the internal circuitry of the audible alarm. This method of controlling the sound level will probably not work well in the following cases:

1. The sound level of electro-magnetic type alarms do not vary much over the voltage range of these devices, so most electro-magnetic type alarms are not suitable for this method.
2. When you only have a narrow operating voltage range to work with. For example, if you are using the MSR320R at 5 Vdc, the sound level change from 5 Vdc to 3 Vdc is not very much.
3. When the voltage range of the audible alarm is narrow. For example, panel mount model SC307NR only has a voltage range of 3 to 7 Vdc. Over this range, the sound level will vary by only 6 dB. This sound level change is significant, but may not be enough to make a difference in the application.

## Tube and Tape-n-Reel Counts- All P/N's

Part Number	Tube Count	Reel Count
ASI301Q	35	
ASI301TRQ		250
ASI401Q	35	
ASI401TRQ		250
AST100Q	25	
AST100TRQ		500
AST1109MLTRQ		1000
AST1240MLTRQ		1000
AST1440MATRQ		600
AST1575BMATRQ		300
AST1628MATRQ		800
AST1750MATRQ		400
AST200Q	48	
AST200TRQ		1000
AST501Q	35	
AST501TRQ		450
AST605Q	35	
AST605TRQ		300

Part Number	Tube Count	Reel Count
AST612Q	35	
AST612TRQ		450
AST7525MATRQ		1000
PB-1220PQ	40	
PB-1221PQ	40	
PB-1224PE-05Q	40	
PB-12N23P-01Q	40	
PB-12N23P-03Q	40	
PB-12N23P-05Q	40	
PB-12N23P-12Q	40	

## Typical Failure Modes of Piezoelectric Audible Alarms

Component/Subsystem	Failure Mode	End Result	Occurrence
Circuit Components (Resistors, Capacitors, Diodes, IC's, etc.)	Over-voltage by customer's application	Unit ceases working.	Vast Majority of Returns
Transducer/Wire Solder Operation	Not enough wire strands in solder joint	Wire breaks after period of time & unit ceases sounding	Rare
Physical Assembly	Transducer wire pinched, adhesive/epoxy run down onto transducer, or RTV adhesive seal failure	Intermittent operation	Rare
Soldering Operation	Incorrect Solder Temperature or Time Causing Cold Solder Joint	Intermittent operation or unit ceases working after period of time	Very Rare
Circuit Components	Random Component Failure; Wrong Component Used; Missing Component	Unit ceases working under normal operating conditions	Very Rare
Transducer Wire	Defect in Wire; Wire Strands Damaged in Production	Wire breaks after period of time & unit ceases sounding	Very Rare
Piezo Transducer	Incorrect Polarization by Manufacturer; Glue Bonding Failure	Sound volume level decreases over time.	Exceedingly Rare

### Notes:

1. Customer returns of Mallory audible alarms for failure to operate are very rare. Of the few parts returned each year, the vast majority of the root cause of failure is an over-voltage or voltage spike condition caused by the customer's application.
2. All Mallory alarms are, at a minimum, function tested 100% during production, and a final audit is performed. Mallory SC/SBM/SBT/SBS/SNP/LSC/VSB/MSR/MSO/ZA series of alarms are audited 100% at final test by checking that sound level, frequency, and current are within specification limits from 2 to 4 different voltage levels.