



Chipsmall Limited consists of a professional team with an average of over 10 year of expertise in the distribution of electronic components. Based in Hongkong, we have already established firm and mutual-benefit business relationships with customers from,Europe,America and south Asia,supplying obsolete and hard-to-find components to meet their specific needs.

With the principle of "Quality Parts,Customers Priority,Honest Operation,and Considerate Service",our business mainly focus on the distribution of electronic components. Line cards we deal with include Microchip,ALPS,ROHM,Xilinx,Pulse,ON,Everlight and Freescale. Main products comprise IC,Modules,Potentiometer,IC Socket,Relay,Connector.Our parts cover such applications as commercial,industrial, and automotives areas.

We are looking forward to setting up business relationship with you and hope to provide you with the best service and solution. Let us make a better world for our industry!



Contact us

Tel: +86-755-8981 8866 Fax: +86-755-8427 6832

Email & Skype: info@chipsmall.com Web: www.chipsmall.com

Address: A1208, Overseas Decoration Building, #122 Zhenhua RD., Futian, Shenzhen, China



3M™ Pak 5 Plug

0.5 mm Straight SMT Plug

PK5 Series

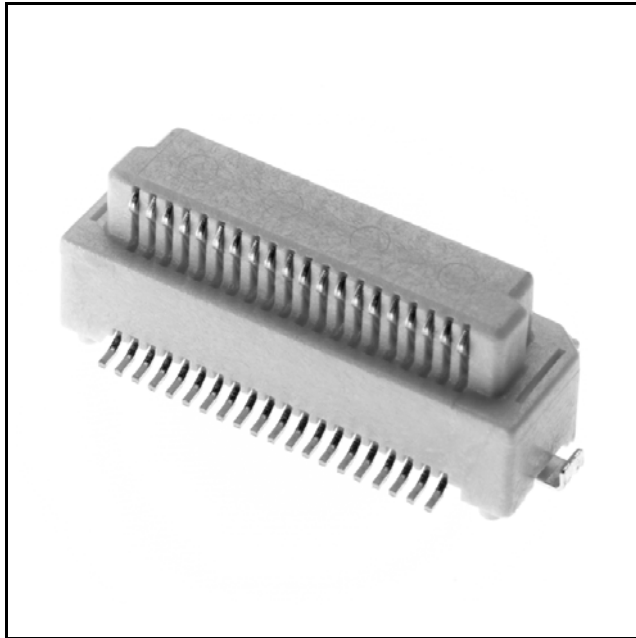

- 0.5 mm pitch high density plug conserves board space
- Mated heights available from 4 to 8 mm
- Surface mount design allows for easy inspection and repair of solder tails
- Tape and reel packaging available
- RoHS* compliant

Date Modified: July 25, 2006

TS-1153-02
Sheet 1 of 4

Physical

Insulation

Material: Glass filled LCP
Flammability: UL 94V-0
Color: White

Contact

Material: Copper Alloy

Plating

Underplating: Nickel
Wiping Area: $2 \mu\text{m}$ [$0.05 \mu\text{m}$] min. Gold over Nickel
Solder Tails: Gold over Nickel

Electrical

Current Rating: 0.3 A
Insulation Resistance: $10^3 \text{ M}\Omega$ min at 250 VDC
Withstanding Voltage: 200 VAC for 1 minute

Environmental

Temperature Rating: -55°C to $+85^\circ\text{C}$
Process Rating: 260°C (per J-STD-020C)

* RoHS = Directive 2002/95/EC, Restriction of the Use of Certain Hazardous Substances in Electrical and Electronic Equipment
"RoHS compliant" means that the product or part does not contain any of the following substances in excess of the following maximum concentration values in any homogeneous material, unless the substance is in an application that is exempt under RoHS: (a) 0.1% (by weight) for lead, mercury, hexavalent chromium, polybrominated biphenyls or polybrominated diphenyl ethers; or (b) 0.01% (by weight) for cadmium. Unless otherwise stated by 3M in writing, this information represents 3M's knowledge and belief based upon information provided by third party suppliers to 3M.

3M™ Pak 5 Plug

0.5 mm Straight SMT Plug

PK5 Series

Plug for 4, 5, 6 mm stacked height.

Product Table / Dimensions

| Contact Quantity | A | B | C | D | E | F | G | H |
|------------------|------------------|------------------|------------------|------------------|------------------|------------------|------------------|------------------|
| 40 | 9.50 [0.374] | 10.62 [0.418] | 11.52 [0.454] | 13.22 [0.520] | 10.50 [0.413] | 11.76 [0.463] | 14.54 [0.572] | 13.59 [0.535] |
| 50 | 12.00 [0.472] | 13.12 [0.517] | 14.02 [0.552] | 15.72 [0.619] | 13.00 [0.512] | 14.26 [0.561] | 17.04 [0.671] | 16.09 [0.633] |
| 60 | 14.50 [0.571] | 15.62 [0.615] | 16.52 [0.650] | 18.22 [0.717] | 15.50 [0.610] | 16.76 [0.660] | 19.54 [0.769] | 18.59 [0.732] |
| 80 | 19.50 [0.768] | 20.62 [0.812] | 21.52 [0.847] | 23.22 [0.914] | 20.50 [0.807] | 21.76 [0.857] | 24.54 [0.966] | 23.59 [0.929] |
| 100 | 24.50 [0.965] | 25.62 [1.009] | 26.52 [1.044] | 28.22 [1.111] | 25.50 [1.004] | 26.76 [1.054] | 29.54 [1.163] | 28.59 [1.126] |
| 120 | 29.50 [1.161] | 30.62 [1.206] | 31.52 [1.241] | 33.22 [1.308] | 30.50 [1.201] | 31.76 [1.250] | 34.54 [1.360] | 33.59 [1.322] |
| 140 | 34.50 [1.358] | 35.62 [1.402] | 36.52 [1.438] | 38.22 [1.505] | 35.50 [1.398] | 36.76 [1.447] | 39.54 [1.557] | 38.59 [1.519] |
| 160 | 39.50 [1.555] | 40.62 [1.599] | 41.52 [1.635] | 43.22 [1.702] | 40.50 [1.594] | 41.76 [1.644] | 44.54 [1.754] | 43.59 [1.716] |

X-X' Cross Section

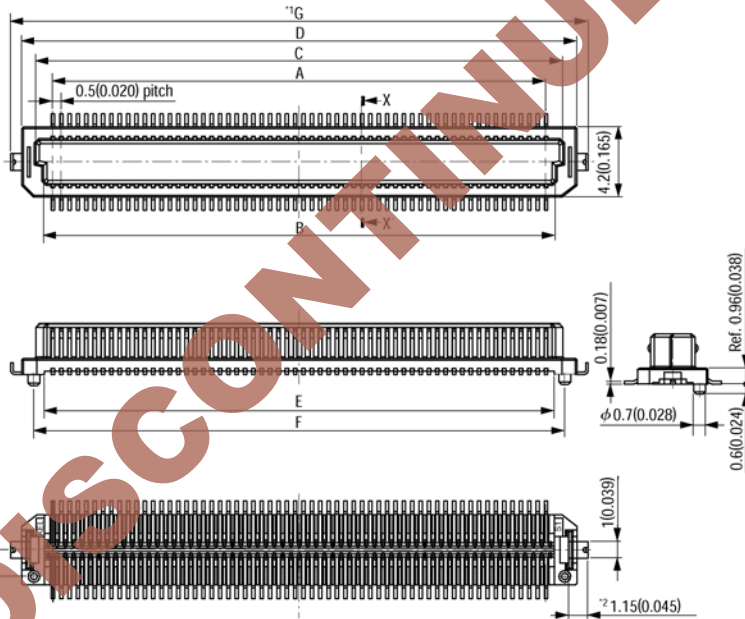
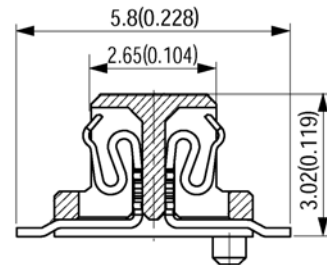

Printed Circuit Board Layout (Component Side View)

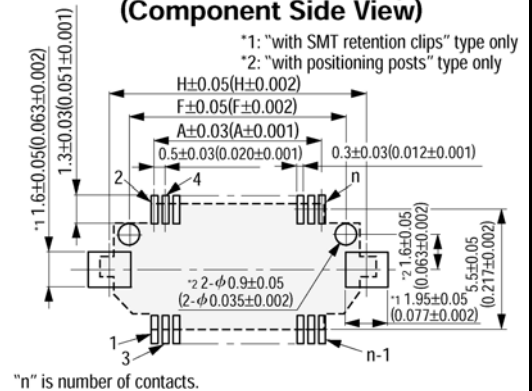

3M™ Pak 5 Plug

0.5 mm Straight SMT Plug

PK5 Series

Plug for 6, 7, 8 mm stacked height.

Product Table / Dimensions

| Contact Quantity | A | B | C | D | E | F | G | H |
|------------------|---------|---------|---------|---------|---------|---------|---------|---------|
| 40 | 9.50 | 10.62 | 11.52 | 13.22 | 10.50 | 11.76 | 14.54 | 13.59 |
| | [0.374] | [0.418] | [0.454] | [0.520] | [0.413] | [0.463] | [0.572] | [0.535] |
| 50 | 12.00 | 13.12 | 14.02 | 15.72 | 13.00 | 14.26 | 17.04 | 16.09 |
| | [0.472] | [0.517] | [0.552] | [0.619] | [0.512] | [0.561] | [0.671] | [0.633] |
| 60 | 14.50 | 15.62 | 16.52 | 18.22 | 15.50 | 16.76 | 19.54 | 18.59 |
| | [0.571] | [0.615] | [0.650] | [0.717] | [0.610] | [0.660] | [0.769] | [0.732] |
| 80 | 19.50 | 20.62 | 21.52 | 23.22 | 20.50 | 21.76 | 24.54 | 23.59 |
| | [0.768] | [0.812] | [0.847] | [0.914] | [0.807] | [0.857] | [0.966] | [0.929] |
| 100 | 24.50 | 25.62 | 26.52 | 28.22 | 25.50 | 26.76 | 29.54 | 28.59 |
| | [0.965] | [1.009] | [1.044] | [1.111] | [1.004] | [1.054] | [1.163] | [1.126] |
| 120 | 29.50 | 30.62 | 31.52 | 33.22 | 30.50 | 31.76 | 34.54 | 33.59 |
| | [1.161] | [1.206] | [1.241] | [1.308] | [1.201] | [1.250] | [1.360] | [1.322] |
| 140 | 34.50 | 35.62 | 36.52 | 38.22 | 35.50 | 36.76 | 39.54 | 38.59 |
| | [1.358] | [1.402] | [1.438] | [1.505] | [1.398] | [1.447] | [1.557] | [1.519] |
| 160 | 39.50 | 40.62 | 41.52 | 43.22 | 40.50 | 41.76 | 44.54 | 43.59 |
| | [1.555] | [1.599] | [1.635] | [1.702] | [1.594] | [1.644] | [1.754] | [1.716] |

X-X' Cross Section

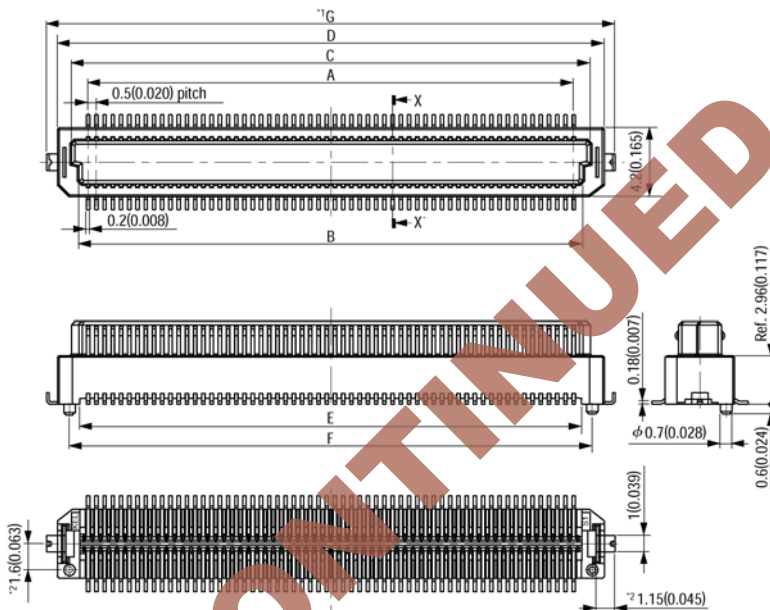
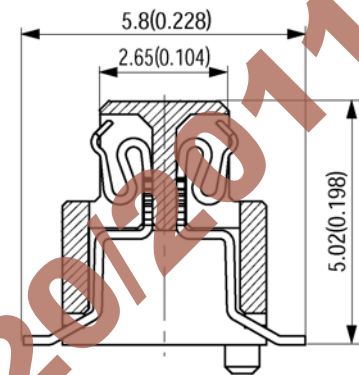

Printed Circuit Board Layout (Component Side View)

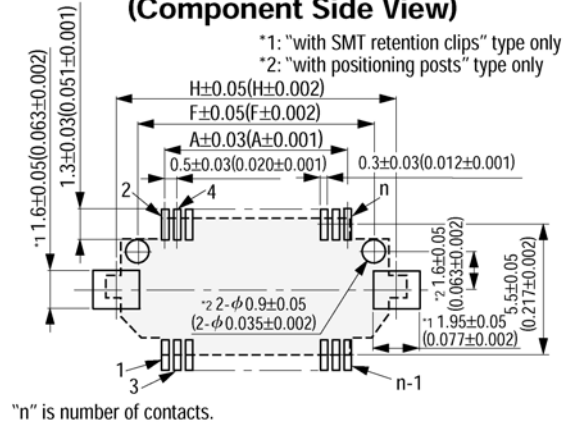

TS-1153-02
 Sheet 3 of 4

3M™ Pak 5 Plug

0.5 mm Straight SMT Plug

PK5 Series

STACKED MATING COMBINATIONS

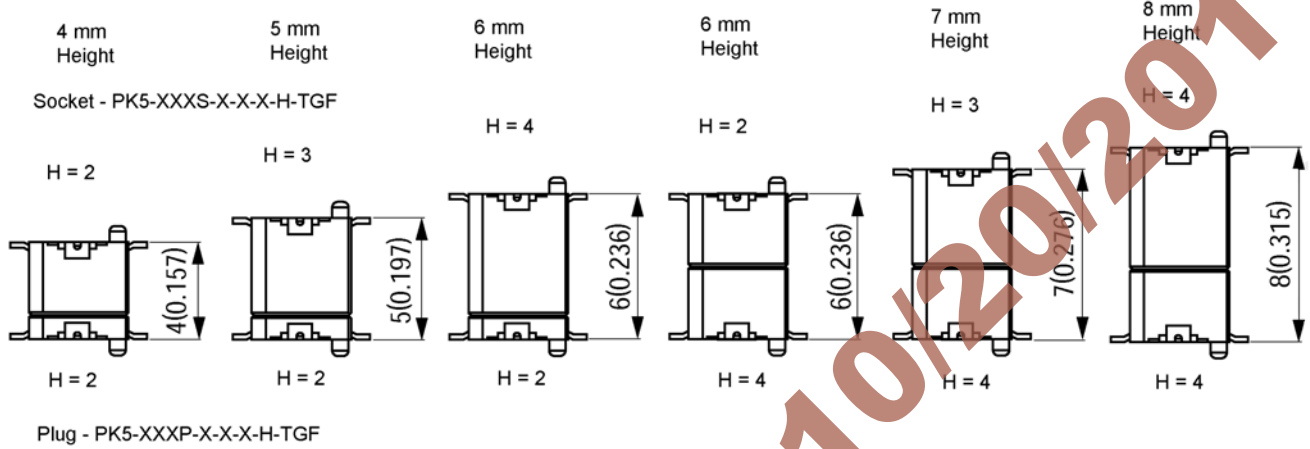

Ordering Information

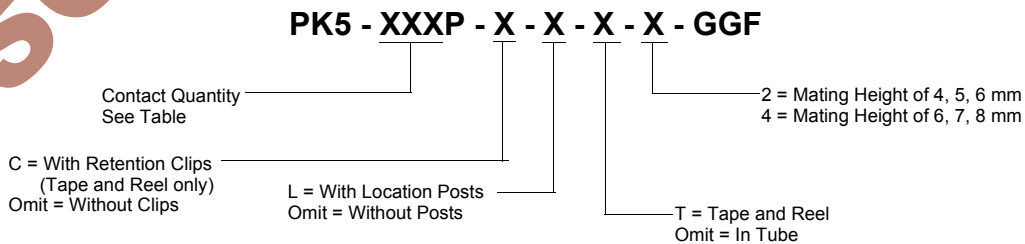

TS-1153-02
Sheet 4 of 4



Interconnect Solutions

<http://www.3M.com/interconnects/>

3M is a trademark of 3M Company.
For technical, sales or ordering information call

800-225-5373

3M CONTINUED 10/20/2011

Important Notice

All statements, technical information, and recommendations related to 3M's products are based on information believed to be reliable, but the accuracy or completeness is not guaranteed. Before using this product, you must evaluate it and determine if it is suitable for your intended application. You assume all risks and liability associated with such use. Any statements related to the product which are not contained in 3M's current publications, or any contrary statements contained on your purchase order shall have no force or effect unless expressly agreed upon, in writing, by an authorized officer of 3M.



3M Electronics

6801 River Place Blvd.
Austin, TX 78726-9000
800/225-5373
www.3M.com/electronics

Warranty; Limited Remedy; Limited Liability.

This product will be free from defects in material and manufacture for a period of one (1) year from the time of purchase. **3M MAKES NO OTHER WARRANTIES INCLUDING, BUT NOT LIMITED TO, ANY IMPLIED WARRANTY OF MERCHANTABILITY OR FITNESS FOR A PARTICULAR PURPOSE.** If this product is defective within the warranty period stated above, your exclusive remedy shall be, at 3M's option, to replace or repair the 3M product or refund the purchase price of the 3M product. **Except where prohibited by law, 3M will not be liable for any indirect, special, incidental or consequential loss or damage arising from this 3M product, regardless of the legal theory asserted.**



Minimum 10%
Post-Consumer Fiber

Printed in USA.

© 3M 2006