



Chipsmall Limited consists of a professional team with an average of over 10 year of expertise in the distribution of electronic components. Based in Hongkong, we have already established firm and mutual-benefit business relationships with customers from,Europe,America and south Asia,supplying obsolete and hard-to-find components to meet their specific needs.

With the principle of “Quality Parts,Customers Priority,Honest Operation,and Considerate Service”,our business mainly focus on the distribution of electronic components. Line cards we deal with include Microchip,ALPS,ROHM,Xilinx,Pulse,ON,Everlight and Freescale. Main products comprise IC,Modules,Potentiometer,IC Socket,Relay,Connector.Our parts cover such applications as commercial,industrial, and automotives areas.

We are looking forward to setting up business relationship with you and hope to provide you with the best service and solution. Let us make a better world for our industry!



Contact us

Tel: +86-755-8981 8866 Fax: +86-755-8427 6832

Email & Skype: info@chipsmall.com Web: www.chipsmall.com





Address: A1208, Overseas Decoration Building, #122 Zhenhua RD., Futian, Shenzhen, China



SMT POWER INDUCTORS

Shielded Drum Core - PL92XX Series



-  **Height:** 0.201 inches (5.1mm) Max
-  **Footprint:** 0.413 inches x 0.413 inches (10.5mm x 10.5mm) Max
-  **Inductance Range:** 0.95µH to 890µH
-  **Current Rating:** up to 8.7A

Electrical Specifications @ 25°C — Operating Temperature -55°C to +130°C

Part Numbers	Inductance @I _{rated} (µH TYP)	I _{rated} ² (A)	DCR (mΩ)		Inductance @0A _{dc} (µH)	Saturation ³ Current (A) @25°C	Heating ⁴ Current (A)
			TYP	MAX			
PL9201	0.95	8.7	4.0	5.7	1.0*	11	8.7
PL9202	1.55	7.4	5.5	7.9	1.6*	8.8	7.4
PL9203	2.32	6.6	6.9	10.0	2.7*	7.3	6.6
PL9204	3.24	5.5	10.0	14.5	3.6*	6.3	5.5
PL9205	4.26	5.1	11.7	16.5	4.5*	5.5	5.1
PL9206	5.64	4.4	15.6	22	6.0*	4.9	4.4
PL9207	7.17	4.2	17.5	25	7.6*	4.4	4.2
PL9208	9.3	3.6	23	35	10	4.0	3.6
PL9209	10.8	3.3	27	37	12	3.7	3.3
PL9210	13.4	3.0	34	47	15	3.4	3.0
PL9211	17.5	2.7	40	58	18	2.9	2.7
PL9212	19.4	2.6	43	67	22	2.8	2.6
PL9213	24.2	2.2	61	79	27	2.4	2.2
PL9214	30.6	2.1	69	94	33	2.2	2.1
PL9215	38.5	1.8	93	126	39	2.0	1.8
PL9216	46.1	1.7	104	140	47	1.8	1.7
PL9217	53.2	1.6	119	157	56	1.7	1.6
PL9218	63.1	1.45	147	202	68.0	1.6	1.45
PL9219	76.6	1.36	165	232	82.0	1.4	1.36
PL9220	88	1.29	184	270	100.0	1.3	1.29
PL9221	112	1.07	264	316	120.0	1.2	1.07
PL9222	135	1.02	294	456	150.0	1.05	1.02
PL9223	132	0.87	328	497	180.0	0.96	0.87
PL9224	198	0.82	450	681	220.0	0.86	0.82
PL9225	237	0.78	502	775	270	0.79	0.78
PL9226	296	0.66	691	955	330	0.71	0.66
PL9227	355	0.58	916	1087	390	0.66	0.58
PL9228	445	0.54	1037	1403	470	0.59	0.54
PL9229	495	0.53	1095	1623	560	0.54	0.53
PL9230	610	0.49	1220	1824	680	0.49	0.50
PL9231	702	0.43	1656	2355	820	0.45	0.43
PL9232	890	0.40	1885	2850	1000	0.41	0.40

*Inductance at 0A_{dc} tolerance on indicated part numbers is ±30%; tolerance is ±20% on all other parts. Optional Tape & Reel packaging can be ordered by adding a "T" suffix to the part number (i.e. PL9201 becomes PL9201T).

NOTES FROM TABLE: (See back page)

Mechanical

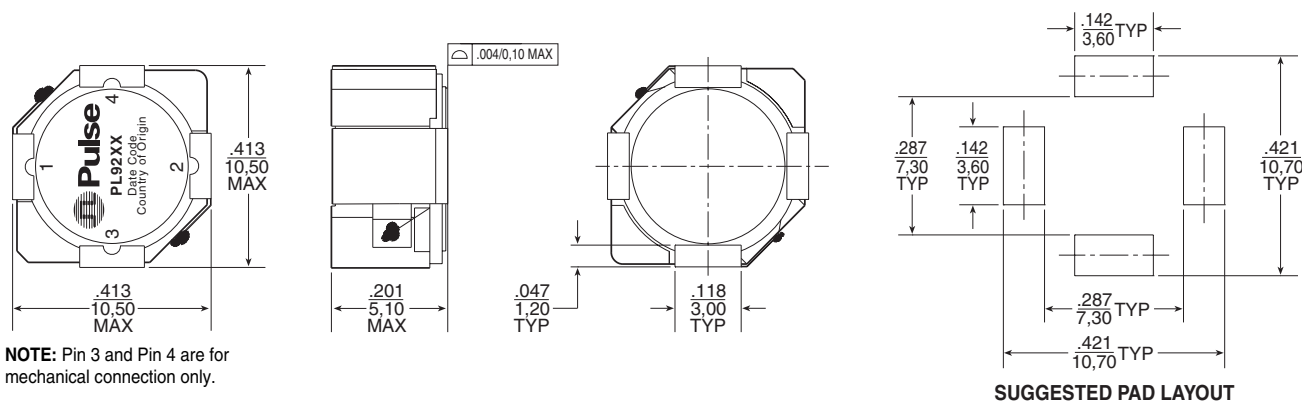

SUGGESTED PAD LAYOUT

SMT POWER INDUCTORS

Shielded Drum Core - PL92XX Series



Notes from Tables

1. Temperature of the component (ambient plus temperature rise) must be within specified operating temperature range.
2. The rated current as listed is either the saturation current or the heating current depending on which value is lower.
3. The saturation current is the current which causes the inductance to drop to 75% of its initial inductance at zero bias. This current is determined by placing the component at room ambient (25°C), and applying a short duration pulse current (to eliminate self-heating effects) to the component.
4. The heating current is the DC current, which causes the temperature of the part to increase by approximately 40°C. This current is determined by extending the terminals of the component with 30mm length 28 gauge buss wires and applying the current to the device for 30 minutes. The temperature is measured by placing the thermocouple between the winding and the shield.
5. In high volt*time applications, additional heating in the component can occur due to core losses in the inductor which may necessitate derating the current in order to limit the temperature rise of the component. In order to determine the approximate total loss (or temperature rise) for a given application, both copper losses and core losses should be taken into account.

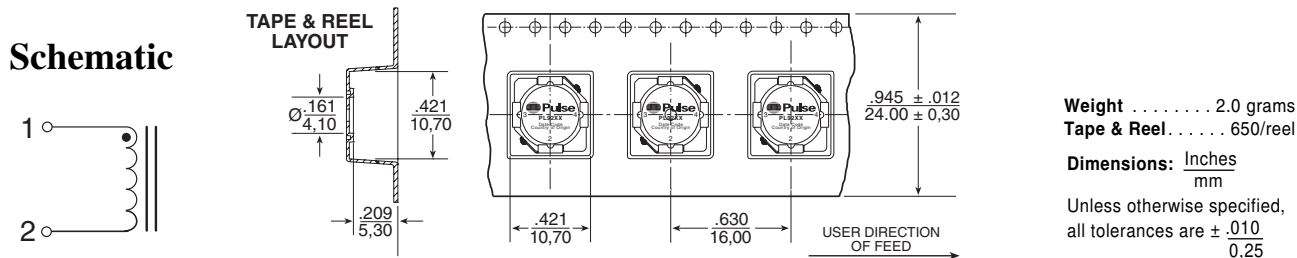

Inductance vs Current Characteristics

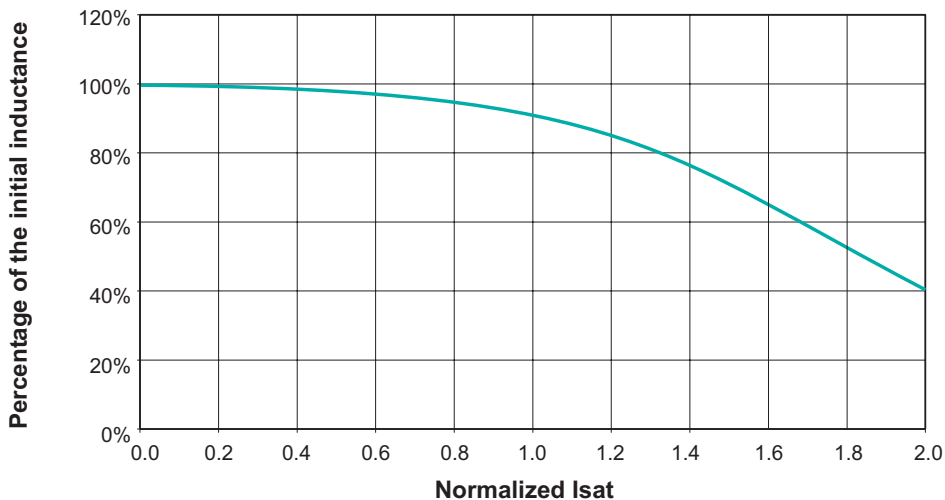

For More Information:

Pulse Worldwide Headquarters
 2 Pearl Buck Court
 Bristol, PA 19007
 U.S.A.
www.pulseeng.com

Pulse Europe
 Einsteinstrasse 1
 D-71083 Herrenberg
 Germany

Pulse China Headquarters
 B402, Shenzhen
 Tech-Innovation International
 Tenth Kejinan Rd.
 High-Tech Industrial Park
 Nanshan District, Shenzhen
 China
 Tel: 86 755 33966678
 Fax: 86 755 33966700

Pulse North China
 Room 1503
 XinYin Building
 No. 888 YiShan Rd.
 Shanghai 200233
 China
 Tel: 86 21 54643211/2
 Fax: 86 21 54643210

Pulse South Asia
 150 Kampong Ampat
 #07-01/02
 KA Centre
 Singapore 368324
 Tel: 65 6287 8998
 Fax: 65 6280 0080

Pulse North Asia
 No. 26
 Kao Ching Rd.
 Yang Mei Chen
 Taoyuan Hsien
 Taiwan, R. O. C.
 Tel: 886 3 4641811
 Fax: 886 3 4641911

Tel: 215 781 6400
 Fax: 215 781 6403

Tel: 49 7032 7806 0
 Fax: 49 7032 7806 12

Performance warranty of products offered on this data sheet is limited to the parameters specified. Data is subject to change without notice. Other brand and product names mentioned herein may be trademarks or registered trademarks of their respective owners. © Copyright, 2007. Pulse Engineering, Inc. All rights reserved.