



Chipsmall Limited consists of a professional team with an average of over 10 year of expertise in the distribution of electronic components. Based in Hongkong, we have already established firm and mutual-benefit business relationships with customers from,Europe,America and south Asia,supplying obsolete and hard-to-find components to meet their specific needs.

With the principle of “Quality Parts,Customers Priority,Honest Operation,and Considerate Service”,our business mainly focus on the distribution of electronic components. Line cards we deal with include Microchip,ALPS,ROHM,Xilinx,Pulse,ON,Everlight and Freescale. Main products comprise IC,Modules,Potentiometer,IC Socket,Relay,Connector.Our parts cover such applications as commercial,industrial, and automotives areas.

We are looking forward to setting up business relationship with you and hope to provide you with the best service and solution. Let us make a better world for our industry!



Contact us

Tel: +86-755-8981 8866 Fax: +86-755-8427 6832

Email & Skype: info@chipsmall.com Web: www.chipsmall.com

Address: A1208, Overseas Decoration Building, #122 Zhenhua RD., Futian, Shenzhen, China



Electrical Specifications

Input Voltage Range:	100-277 Vac Nom. (90-305 V Min/Max)
Input Over-Voltage:	Can endure 320Vac for 48 Hrs, 350Vac for 2 Hrs
Frequency:	50/60 Hz Nom. (47-63 Hz Min/Max)
Power Factor:	>0.90 @ 75-100% load, 100-277Vac
Inrush Current:	<50.0 Amps max @ 277Vac, cold start 25°C
Input Current:	0.80 Amps max
Maximum Power:	60W
Current Regulation:	± 3% Over input line variation
Load Regulation:	± 4%
THD:	≤ 20% @ 75-100% load, 100-277Vac

Ripple & Noise: (Vpk-pk) 5% Vo max @ 20 MHz BW, Full load output in parallel with 0.1 µF ceramic & 10 µF Electrolytic

Ripple: (Ipk-pk) 5% Io max @ 20 MHz BW, Full load output in parallel with 0.1 µF ceramic & 10 µF Electrolytic. 120 Hz component (Flicker Free)

Start-up Time: 200mS typical @ Full Load, 120Vac/60Hz (1000mS max)

Leakage Current: 0.28 mA max @ 120Vac, 0.78 mA max @ 277Vac

Hold Up Time: 40mS typical @ Full Load, 277Vac

Protections

Over-voltage Output

Over-current Output

Short Circuit Auto Recovery

Environmental Specifications

Max Case Life Temp: (5 year warranty) 70°C

Maximum Case Temp (UL): 90°C

Minimum Starting Temp: -30°C

Storage Temperature: -40°C to +85°C

UL Type TL Rating: Class 2: 86/63°C; Non-Class 2: 90/81°C

Humidity: 5% to 95%

Cooling: Convection

Vibration Frequency: 5 to 55 Hz/2g, 30 minutes

Sound Rating: Class A

Impact Resistance: 1g/s

MTBF: 474,000 Hours at full load and 40°C ambient conditions per MIL-217F Notice 2

EMC: FCC 47CFR Part 15 Class B compliant

Weight: 19 oz. (538 g)

Dimming Option:

“-D” 0-10V & Resistance dimmable models include an extra two wires +Purple/-Gray on the output side. “-D” Compatible with most quality 0-10V wall dimmers. See page 3.

“-D3” 3-wire dimmable model dims 100% to 10%. Three extra wires included on the output side: Yellow/Purple/Gray. This model is suitable for potentiometer dimming. See page 3.

Note:

LED drivers are designed and intended to operate LED loads only. Non-LED loading may be outside the specified design limits of our LED drivers, and therefore cannot be covered by any warranty. If you desire to use our LED drivers to operate non-LED loads please contact us to discuss compatibility.



Constant Current Models

Model	Output Current (mA ±3%)	Output Voltage Range (Vdc)	Max. Output Power (W)	Max Efficiency
PLED60W-214-C0280-XX	280	72-214	60	91%
PLED60W-166-C0360-XX	360	56-166	60	91%
PLED60W-108-C0550-XX	550	36-108	60	90%
PLED60W-072-C0850-XX	850	24-72	60	90%
PLED60W-054-C1050-XX	1050	18-54	56.7	88%
PLED60W-054-C1100-XX	1100	18-54	60	88%
PLED60W-048-C1250-XX	1250	16-48	60	88%
PLED60W-042-C1400-XX	1400	14-42	58.8	86%
PLED60W-042-C1450-XX	1450	14-42	60	86%
PLED60W-036-C1670-XX	1670	12-36	60	86%
PLED60W-027-C2250-XX	2250	9-27	60	85%
PLED60W-024-C2500-XX	2500	8-24	60	85%
PLED60W-020-C3000-XX	3000	7-20	60	84%
PLED60W-015-C4000-XX	4000	5-15	60	84%
PLED60W-012-C5000-XX	5000	4-12	60	84%

-XX indicates dimming options are available. See options at left. Blank = fixed current output

Constant Voltage Models

Model	Output Voltage (Vdc ±5%)	Output Current Range (mA)	Max. Output Power (W)	Max Efficiency
PLED60W-012	12	1563-5000	60	84%
PLED60W-015	15	1250-4000	60	84%
PLED60W-020	20	938-3000	60	84%
PLED60W-024	24	783-2500	60	85%
PLED60W-027	27	700-2250	60	85%
PLED60W-036	36	525-1670	60	86%
PLED60W-042	42	448-1450	60	86%
PLED60W-048	48	390-1250	60	88%
PLED60W-054	54	350-1200	60	88%
PLED60W-072	72	263-850	60	90%
PLED60W-108	108	175-550	60	90%
PLED60W-166	166	113-360	60	91%
PLED60W-214	214	88-280	60	91%

• Indicates S.A.M.

Class 2: US/Canada

- Smallest Footprint Driver for this wattage
- Total Power: 60 Watts
- Input Voltage: 100-277 Vac Nom.
- UL Dry & Damp Location Rated
- IP66 & NEMA6
- Constant Current & Constant Voltage with Isolation
- Black Magic Thermal Advantage™ Aluminum Housing
- UL Type HL Rated for Hazardous Locations
- UL Sign Components Manual (S.A.M. Models)

Dimensions

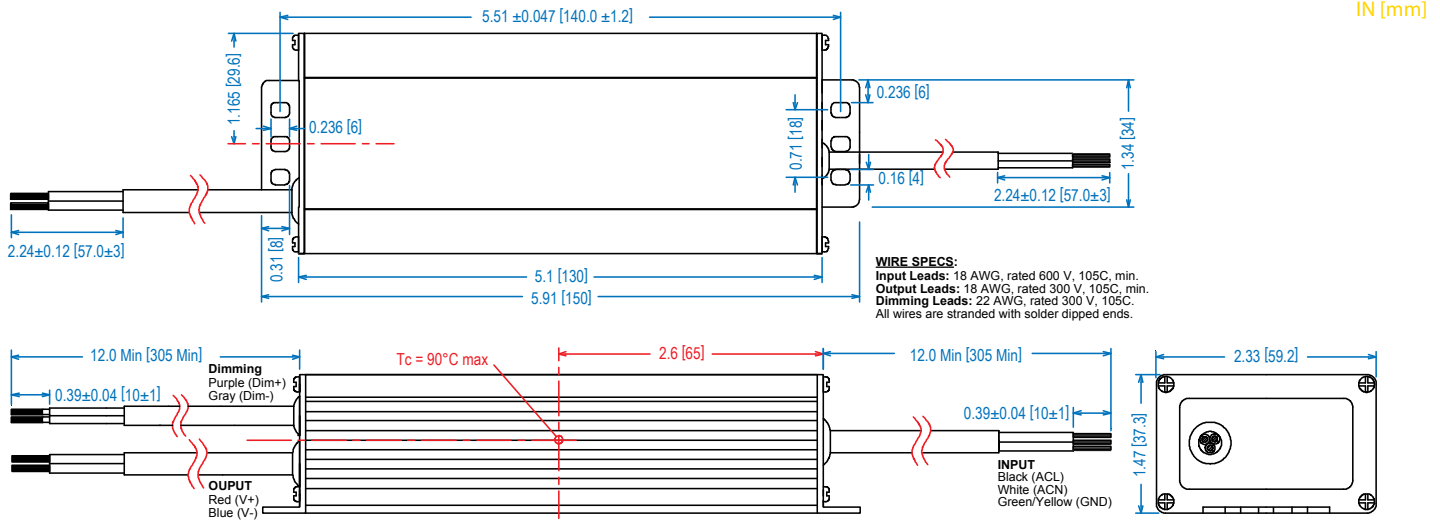

Power Characteristics

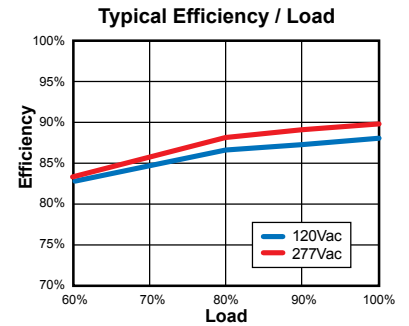
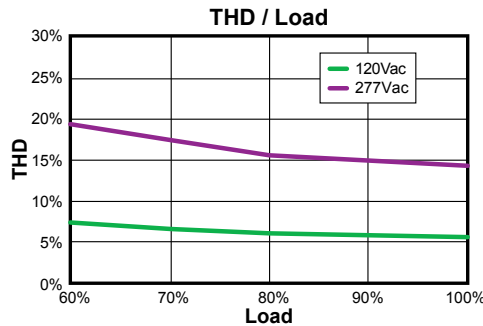
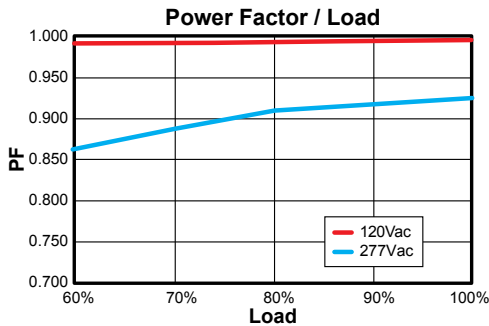

Lifetime / Case Temperature
Full Load @ 120Vac

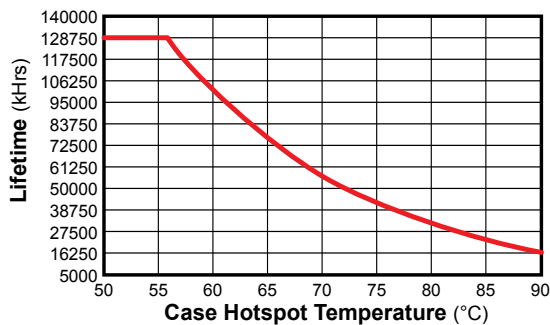

Safety Cert. Standard

UL/CUL	UL8750 & CAN/CSA-22.2 No. 250.13-12, UL1310/CSA-C22.2 No.223-M91, UL1012/CSA-C22.2 No.107.1 for Non-Class 2
CE	EN 61347-1, EN61347-2-13

EMC Standard Notes

FCC, 47CFR Part 15	Class B
EN 55015	Limits and methods of measurement of radio disturbance characteristics of electrical lighting and similar equipment.
EN 61000-3-2	Part 3-2: Limits for harmonic current emissions Class C, >80% Rated Power
EN 61000-3-3	Part 3-3: Limitation of voltage changes, voltage fluctuations and flicker.
EN 61000-4-5	Part 4-5: Surge Immunity test, 2 kV L-N, 4 kV L-G & N-G

UL Conditions of Acceptability

See website for additional information

Note: The area under the life-temperature curve represents where the driver has highly reliable operation within specification. Driver performance may drift out of published specifications as the hours of operation exceed the curve at a given temperature. Higher operating temperatures increase the chances of a failure to function. Other electrical, mechanical and environmental factors affect driver lifetime but are not represented in this calculation.

“-D” and “-D3” Options: 0-10VDC and Resistance Dimming

Parameters	Minimum	Typical	Maximum
10V Output, Yellow Wire	9.2V	10.0V	10.8V
Source Current out of Aux Yellow Wire	—	—	10mA
Absolute Voltage Range on 0-10V (+) Purple Wire	-2.0V	—	+15V
Source Current out of 0-10V Purple Wire	0mA	—	2mA

Typical Dimming Circuit

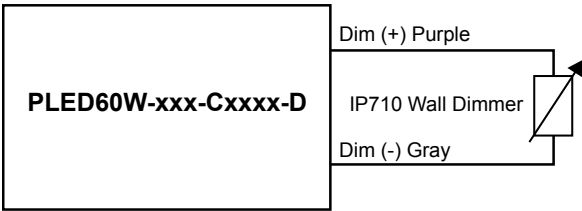

(Dimmer must be current-sink type control)

3-Wire Dimming Typical Circuit

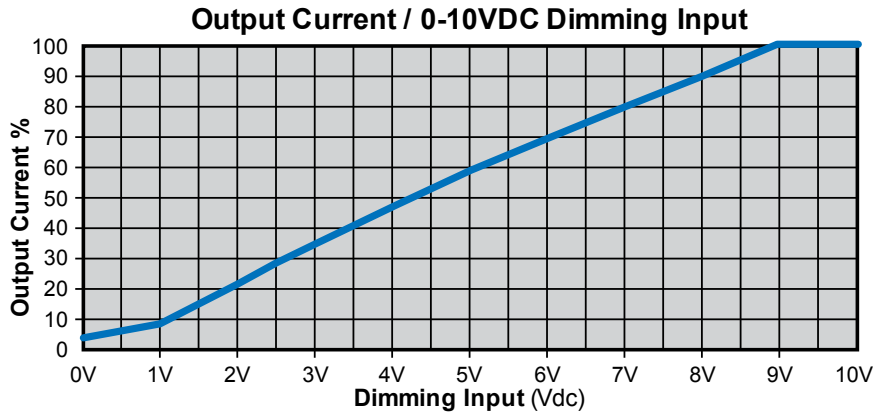
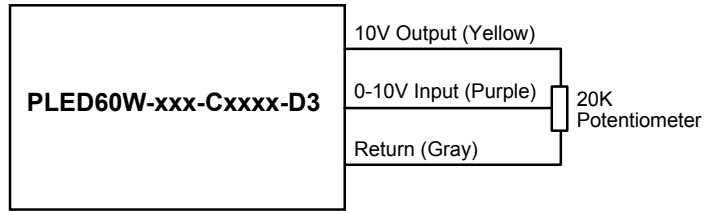

Notes:

1. 0-10V dimmable version comes with an extra two wires +Purple/-Gray on the output side.
2. Compatible with most 0-10V Wall Slide dimmers and direct 0-10V analog signal. Recommended dimmer is Leviton IP710 or equivalent
3. 0-10V dimmable version is not intended to dim below about 5% @ 0V or 10% @ 1.0V
4. 0-10V dimmable version output will be 100% with Purple/Gray open and minimum with Purple/Gray Shorted.
5. 3-wire dimmable drivers come with three wires on the output side (Yellow/Purple/Gray).