



Chipsmall Limited consists of a professional team with an average of over 10 year of expertise in the distribution of electronic components. Based in Hongkong, we have already established firm and mutual-benefit business relationships with customers from,Europe,America and south Asia,supplying obsolete and hard-to-find components to meet their specific needs.

With the principle of “Quality Parts,Customers Priority,Honest Operation,and Considerate Service”,our business mainly focus on the distribution of electronic components. Line cards we deal with include Microchip,ALPS,ROHM,Xilinx,Pulse,ON,Everlight and Freescale. Main products comprise IC,Modules,Potentiometer,IC Socket,Relay,Connector.Our parts cover such applications as commercial,industrial, and automotives areas.

We are looking forward to setting up business relationship with you and hope to provide you with the best service and solution. Let us make a better world for our industry!



Contact us

Tel: +86-755-8981 8866 Fax: +86-755-8427 6832

Email & Skype: info@chipsmall.com Web: www.chipsmall.com

Address: A1208, Overseas Decoration Building, #122 Zhenhua RD., Futian, Shenzhen, China



PLED-96W Series Flicker-Free LED Drivers

select **SYNC**
classic



Electrical Specifications

Input Voltage Range:	100-277 Vac Nom. (90-305 V Min/Max)
Input Over-Voltage:	Can endure 320Vac for 48 Hrs, 350Vac for 2 Hrs
Frequency:	50/60 Hz Nom. (47-63 Hz Min/Max)
Power Factor:	>0.90 @ 60-100% load, 100-277Vac
Inrush Current:	<50.0 Amps max @ 230Vac, cold start 25°C
Input Current:	1.30 Amps max
Maximum Power:	96W
Current Accuracy:	± 2% Over input line variation
Load Regulation:	± 3%
THD:	≤ 20% @ 60-100% load, 100-277Vac
Ripple & Noise: (Vpk-pk)	5% Vo max @ 20 MHz BW, Full load output in parallel with 0.1 µF ceramic & 10 µF Electrolytic
Ripple: (Ipk-pk)	5% Io max @ 20 MHz BW, Full load output in parallel with 0.1 µF ceramic & 10 µF Electrolytic. 120 Hz component (Flicker Free)
Start-up Time:	200mS typical @ Full Load, 120Vac/60Hz (1000mS max)
Leakage Current:	0.28 mA max @ 120Vac, 0.78 mA max @ 277Vac
Hold Up Time:	40mS typical @ Full Load, 277Vac

Protections

Over-voltage	Output
Over-current	Output
Short Circuit	Auto Recovery

Environmental Specifications

Max Case Life Temp: (5 year warranty)	73°C
Maximum Case Temp (UL):	90°C
Minimum Starting Temp:	-30°C
UL Type TL Rating:	Class 2: 83/54°C; Non-Class 2: 90/75°C
Storage Temperature:	-40°C to +85°C
Humidity:	5% to 95%
Cooling:	Convection
Vibration Frequency:	5 to 55 Hz/2g, 30 minutes
Sound Rating:	Class A
Impact Resistance:	1g/s
MTBF:	474,000 Hours @ full load and 40°C ambient conditions per MIL-217F Notice 2
EMC:	FCC 47CFR Part 15 Class B compliant
Weight:	21.6 oz. (612 grams)

Dimming Option:

“-D” 0-10V & Resistance dimmable models include an extra two wires +Purple/-Gray on the output side. “-D” Compatible with most quality 0-10V wall dimmers. See page 3.

“-D3” 3-wire dimmable model dims 100% to 10%. Three extra wires included on the output side: Yellow/Purple/Gray. This model is suitable for potentiometer dimming. See page 3.

Note:

LED drivers are designed and intended to operate LED loads only. Non-LED loading may be outside the specified design limits of our LED drivers, and therefore cannot be covered by any warranty. If you desire to use our LED drivers to operate non-LED loads please contact us to discuss compatibility.

Constant Current Models

Model	Output Current (mA ±3%)	Output Voltage Range (Vdc)	Max. Output Power (W)	Max Efficiency
PLED96W-274-C0350-XX	350	92-274	95.9	92%
PLED96W-213-C0450-XX	450	71-213	95.6	92%
PLED96W-137-C0700-XX	700	46-137	95.9	92%
PLED96W-092-C1050-XX	1050	31-92	96	91%
PLED96W-069-C1400-XX	1400	23-69	96	91%
PLED96W-054-C1750-XX	1750	18-54	94.5	91%
PLED96W-048-C2000-XX	2000	16-48	96	90%
PLED96W-046-C2100-XX	2100	16-46	96	90%
PLED96W-039-C2450-XX	2450	14-39	95.5	89%
PLED96W-036-C2660-XX	2660	12-36	95.7	89%
PLED96W-034-C2800-XX	2800	12-34	95.2	89%
PLED96W-030-C3150-XX	3150	10-30	94.8	89%
PLED96W-027-C3500-XX	3500	9-27	94.5	88%
PLED96W-025-C3840-XX	3840	9-25	96	88%
PLED96W-024-C4000-XX	4000	8-24	96	88%
PLED96W-020-C4800-XX	4800	7-20	96	87%
PLED96W-018-C5350-XX	5350	6-18	96	86%

-XX indicates dimming options are available. See options at left. Blank = fixed current output

Constant Voltage Models

Model	Output Voltage (Vdc ±5%)	Output Current Range (mA)	Max. Output Power (W)	Max Efficiency
PLED96W-018	18	1338-5350	96	86%
PLED96W-020	20	1200-4800	96	87%
PLED96W-024	24	1000-4000	96	88%
PLED96W-025	25	960-3840	96	88%
PLED96W-027	27	875-3500	94.5	88%
PLED96W-030	30	788-3150	94.8	89%
PLED96W-034	34	700-2800	95.2	89%
PLED96W-036	36	665-2660	95.7	89%
PLED96W-039	39	613-2450	95.5	89%
PLED96W-046	46	525-2100	96	90%
PLED96W-048	48	500-2000	96	90%
PLED96W-054	54	438-1750	94.5	91%
PLED96W-069	69	350-1400	96	91%
PLED96W-092	92	263-1050	96	91%
PLED96W-137	137	175-700	95.9	92%
PLED96W-213	213	113-450	95.6	92%
PLED96W-274	274	88-350	95.9	92%

• Indicates S.A.M.

Class 2: US/Canada

- Total Power: 96 Watts
- Constant Current & Constant Voltage with Isolation
- Input Voltage: 100-277 Vac Nom.
- UL Dry & Damp Location Rated
- IP66 & NEMA6
- UL Type TL
- UL Type HL Rated for Hazardous Locations
- UL Sign Components Manual (S.A.M. Models)
- Black Magic Thermal Advantage™ Aluminum Housing

Dimensions

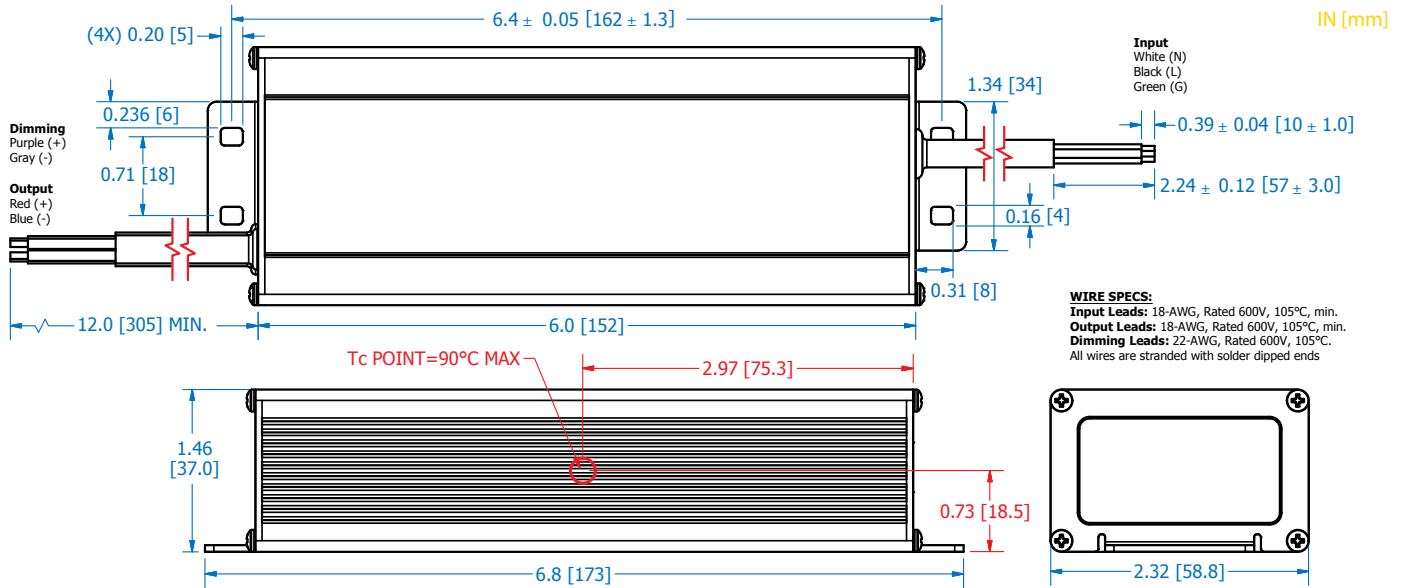

Power Characteristics

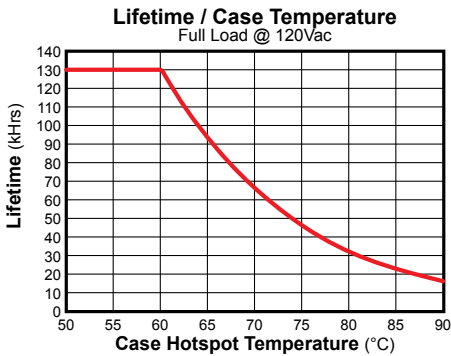
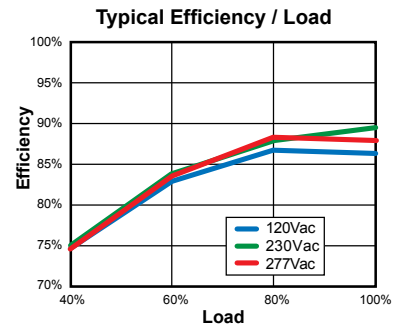
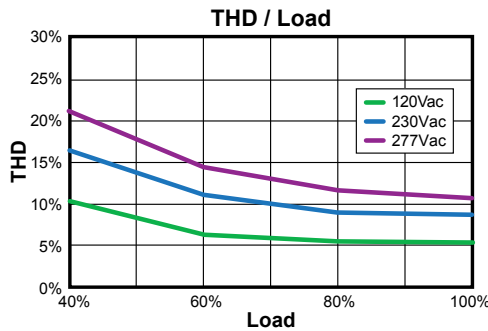
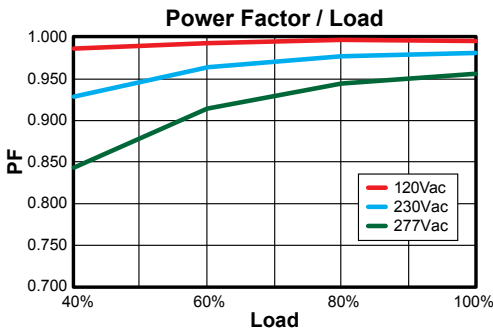

Safety Cert.	Standard
UL/CUL	UL8750 & CAN/CSA-22.2 No. 250.13-12, UL1310/CSA-C22.2 No.223-M91 for Class 2, UL1012/CSA-C22.2 No.107.1 for Non-Class 2
CE	EN 61347-1, EN61347-2-13
EMC Standard	Notes
FCC, 47CFR Part 15	Class B
EN 55015	Limits and methods of measurement of radio disturbance characteristics of electrical lighting and similar equipment.
EN 61000-3-2	Part 3-2: Limits for harmonic current emissions Class C, >80% Rated Power
EN 61000-3-3	Part 3-3: Limitation of voltage changes, voltage fluctuations and flicker.
EN 61000-4-5	Part 4-5: Surge Immunity test, 2 kV L-N, 4 kV L-G & N-G

UL Conditions of Acceptability

See website for additional information

Note: The area under the life-temperature curve represents where the driver has highly reliable operation within specification. Driver performance may drift out of published specifications as the hours of operation exceed the curve at a given temperature. Higher operating temperatures increase the chances of a failure to function. Other electrical, mechanical and environmental factors affect driver lifetime but are not represented in this calculation.

“-D” and “-D3” Options: 0-10VDC and Resistance Dimming

Parameters	Minimum	Typical	Maximum
10V Output, Yellow Wire	9.2V	10.0V	10.8V
Source Current out of Aux Yellow Wire	—	—	10mA
Absolute Voltage Range on 0-10V (+) Purple Wire	-2.0V	—	+15V
Source Current out of 0-10V Purple Wire	0mA	—	2mA

Typical Dimming Circuit

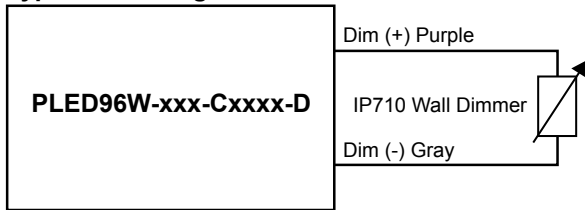

(Dimmer must be current-sink type control)

3-Wire Dimming Typical Circuit

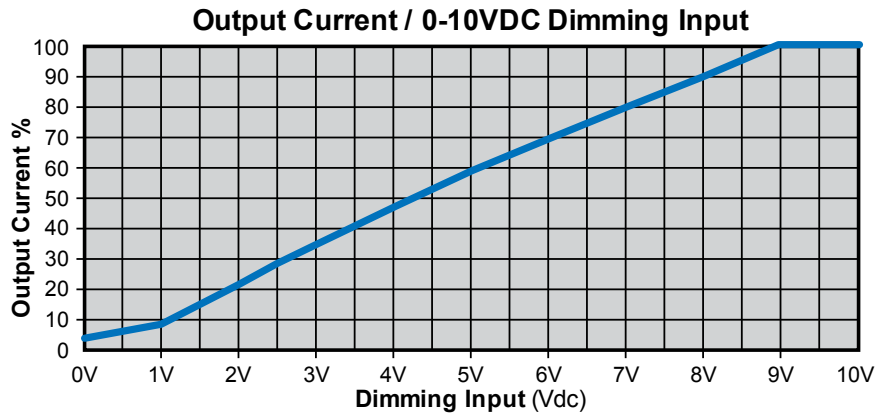
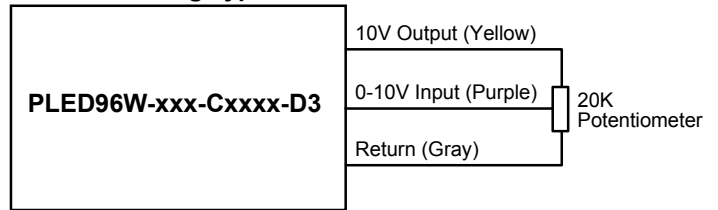

Notes:

- 0-10V dimmable version comes with an extra two wires +Purple/-Gray on the output side.
- Compatible with most 0-10V Wall Slide dimmers and direct 0-10V analog signal. Recommended dimmer is Leviton IP710 or equivalent
- 0-10V dimmable version is not intended to dim below about 5% @ 0V or 10% @ 1.0V
- 0-10V dimmable version output will be 100% with Purple/Gray open and minimum with Purple/Gray Shorted.
- 3-wire dimmable drivers come with three wires on the output side (Yellow/Purple/Gray).