



Chipsmall Limited consists of a professional team with an average of over 10 year of expertise in the distribution of electronic components. Based in Hongkong, we have already established firm and mutual-benefit business relationships with customers from,Europe,America and south Asia,supplying obsolete and hard-to-find components to meet their specific needs.

With the principle of “Quality Parts,Customers Priority,Honest Operation,and Considerate Service”,our business mainly focus on the distribution of electronic components. Line cards we deal with include Microchip,ALPS,ROHM,Xilinx,Pulse,ON,Everlight and Freescale. Main products comprise IC,Modules,Potentiometer,IC Socket,Relay,Connector.Our parts cover such applications as commercial,industrial, and automotives areas.

We are looking forward to setting up business relationship with you and hope to provide you with the best service and solution. Let us make a better world for our industry!



## Contact us

Tel: +86-755-8981 8866 Fax: +86-755-8427 6832

Email & Skype: info@chipsmall.com Web: www.chipsmall.com

Address: A1208, Overseas Decoration Building, #122 Zhenhua RD., Futian, Shenzhen, China



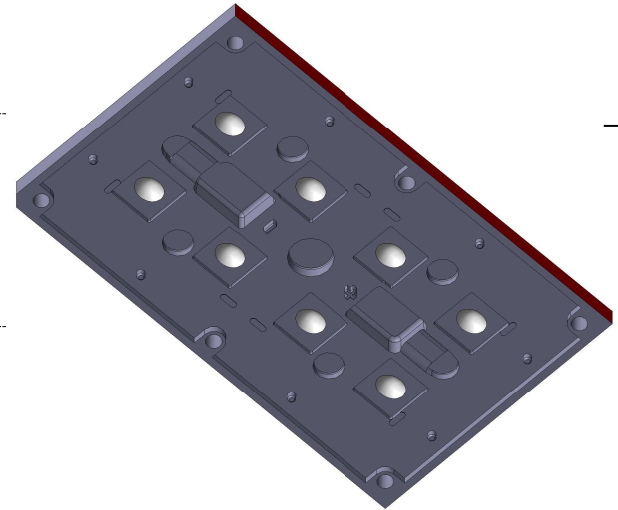
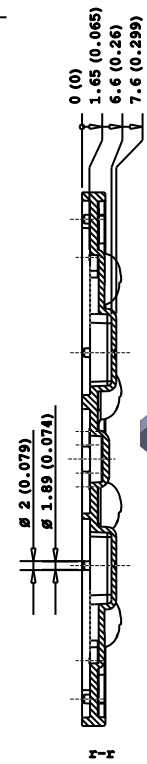
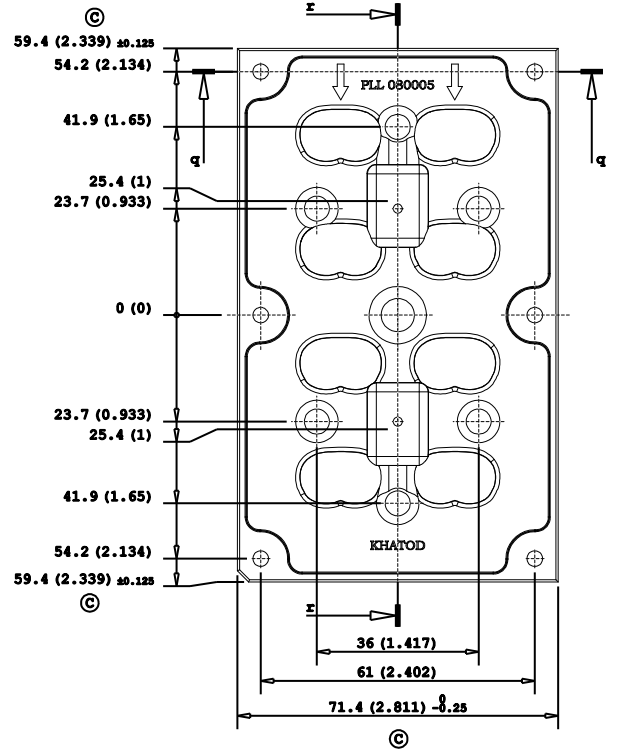
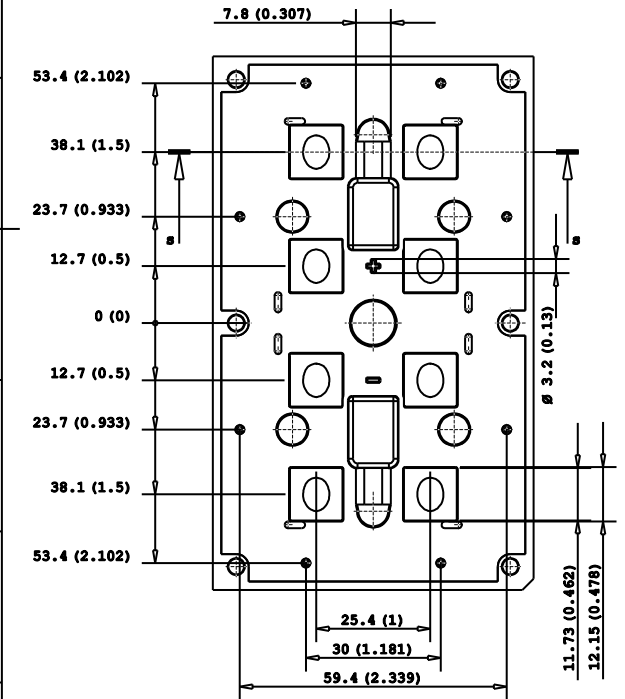
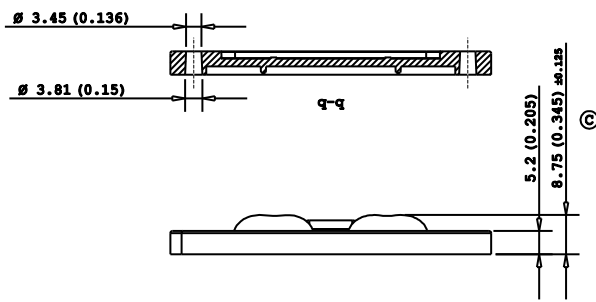
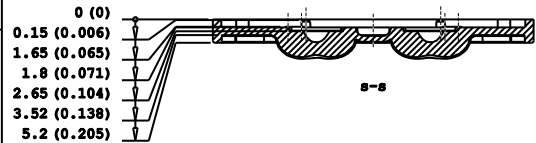
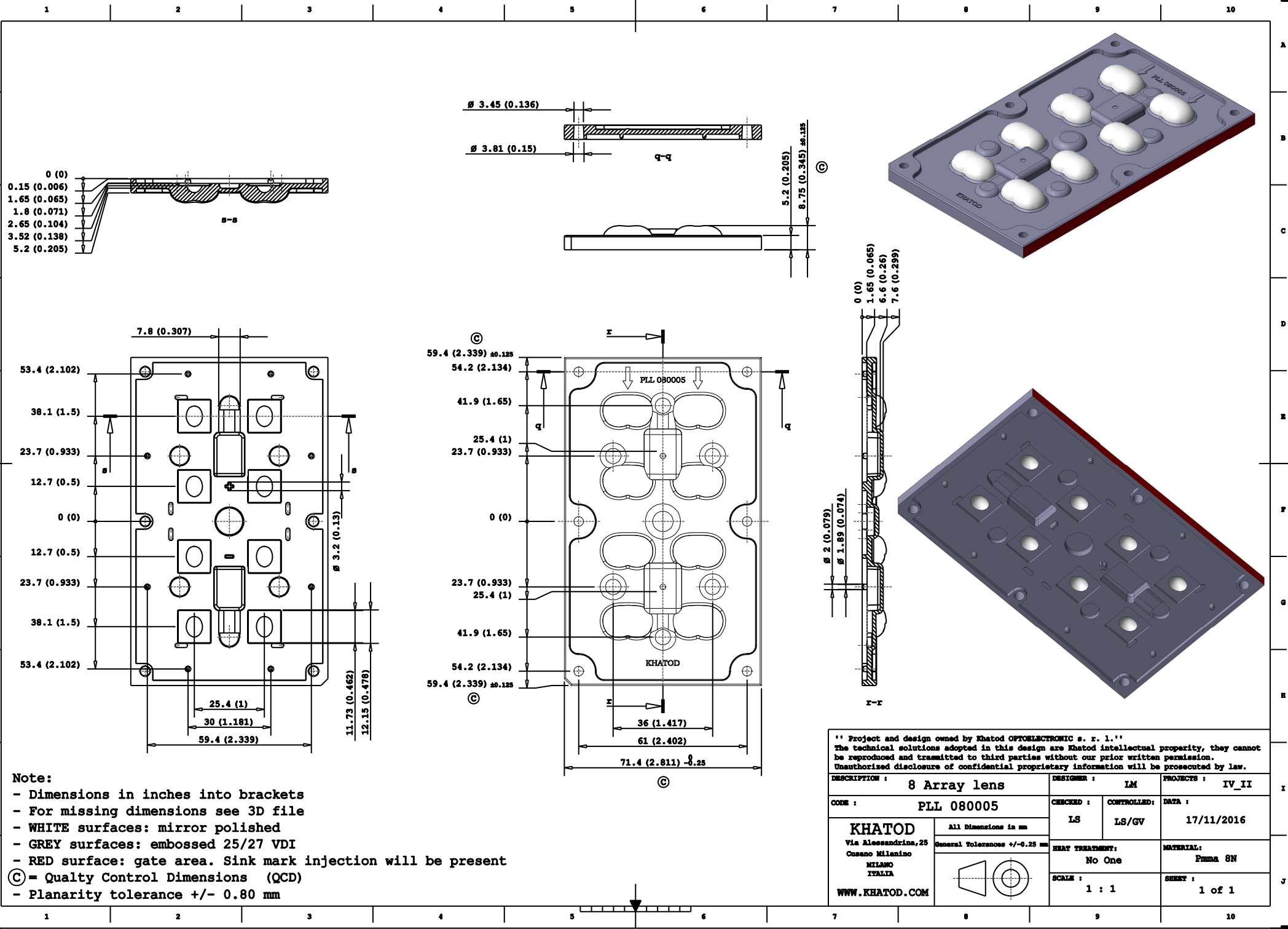

**Note:**

- Dimensions in inches into brackets
- For missing dimensions see 3D file
- WHITE surfaces: mirror polished
- GREY surfaces: embossed 25/27 VDI
- RED surface: gate area. Sink mark injection will be present

© = Quality Control Dimensions (QCD)

- Planarity tolerance +/- 0.80 mm

'' Project and design owned by Khatod OPTOELECTRONIC s. r. l. ''  
The technical solutions adopted in this design are Khatod intellectual property, they cannot be reproduced and transmitted to third parties without our prior written permission. Unauthorized disclosure of confidential proprietary information will be prosecuted by law.

DESCRIPTION : <b>8 Array lens</b>		DESIGNER : LM	PROJECTS : IV_II
CODE : PLL 080005		CHECKED : LS	CONTROLLED: LS/GV
DATA : 17/11/2016			
<b>KHATOD</b> Via Alessandrina,25 Cusano Milanino MILANO ITALIA WWW.KHATOD.COM	All Dimensions in mm General Tolerances +/-0.25 mm		MATERIAL: PMMA 8N
	HEAT TREATMENT: No One		SCALE : 1 : 1
		SHEET : 1 of 1	