



Chipsmall Limited consists of a professional team with an average of over 10 year of expertise in the distribution of electronic components. Based in Hongkong, we have already established firm and mutual-benefit business relationships with customers from,Europe,America and south Asia,supplying obsolete and hard-to-find components to meet their specific needs.

With the principle of “Quality Parts,Customers Priority,Honest Operation,and Considerate Service”,our business mainly focus on the distribution of electronic components. Line cards we deal with include Microchip,ALPS,ROHM,Xilinx,Pulse,ON,Everlight and Freescale. Main products comprise IC,Modules,Potentiometer,IC Socket,Relay,Connector.Our parts cover such applications as commercial,industrial, and automotives areas.

We are looking forward to setting up business relationship with you and hope to provide you with the best service and solution. Let us make a better world for our industry!



Contact us

Tel: +86-755-8981 8866 Fax: +86-755-8427 6832

Email & Skype: info@chipsmall.com Web: www.chipsmall.com

Address: A1208, Overseas Decoration Building, #122 Zhenhua RD., Futian, Shenzhen, China



REV.	DESCRIPTION	DATE	APPROVED
G	Mounting Hole Tolerance Update	01/14/10	T. Y.
H	Updated General Specifications Note 1.	10/01/12	T. Y.
J	Updated For Concavity Face Clarification.	07/29/14	J. C.
K	Added Panel Thickness.	05/01/15	J. C.
L	Added Color Options, Sheet #2.	01/22/16	J. C.

Ø.152 [Ø3.9mm]
LIGHT PIPE

Ø.158 [Ø4.0mm]
REF.

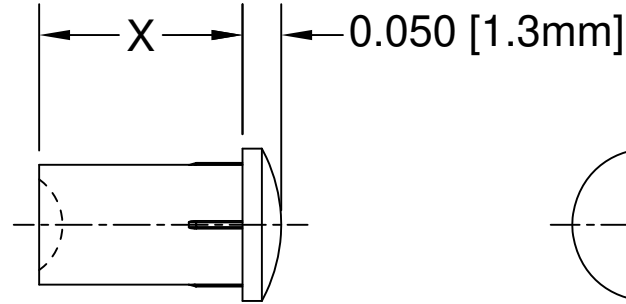
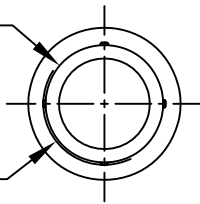

Ø.197 [Ø5.0mm]
FLANGE

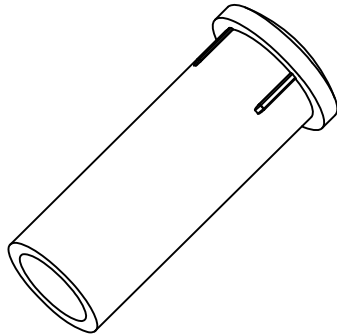
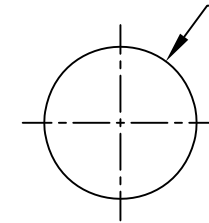

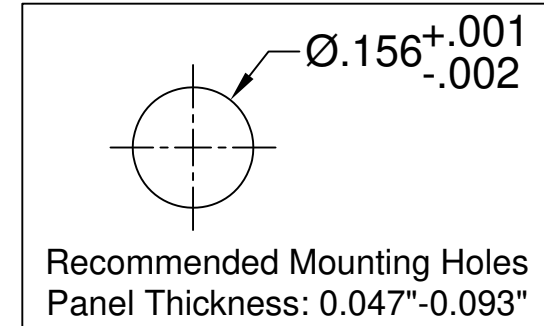

Part No.	X = Body Length
PLP5-2-125	0.125 (3.2mm)
PLP5-2-250	0.250 (6.4mm)
PLP5-2-350	0.350 (8.9mm)
PLP5-2-375	0.375 (9.5mm)
PLP5-2-500	0.500 (12.7mm)
PLP5-2-625	0.625 (15.9mm)
PLP5-2-750	0.750 (19.0mm)
PLP5-2-1000	1.000 (25.4mm)
PLP5-2-1250	1.250 (31.8mm)
PLP5-2-1500	1.500 (38.1mm)



2. MATERIAL: POLYCARBONATE, 94V-0, CLEAR.

1. GENERAL SPECIFICATIONS: BIVAR MOLDED COMPONENT SPECIFICATION BV00-E101 and BSMC-1001.

STANDARD TOLERANCE (UNLESS OTHERWISE SPECIFIED)		 4 THOMAS, IRVINE, CA. 92618 TEL: (949) 951-8808 FAX: (949) 951-3974	
DECIMALS	ANGULAR		
.X ± .1	X° ± 1°	 TITLE: PRESS-FIT PANEL MOUNT LIGHT PIPE, LOW PROFILE ROUND, 5mm	
.XX ± .01			
.XXX ± .005			
DESIGNED: Michael Chen	DATE: 03/05/03	PART NO: PLP5-2-XXX	REVISION: L
CHECKED: D. Green	DATE: 03/05/03	CAGE CODE : 32559	SHEET # 1 OF 2
CAD GENERATED DOCUMENT. DO NOT MEASURE DRAWING.			

OTHER AVAILABLE COLORS

* SEE TABLE FOR ORDERING INFORMATION

REV.	DESCRIPTION	DATE	APPROVED
	SEE SHEET #1		

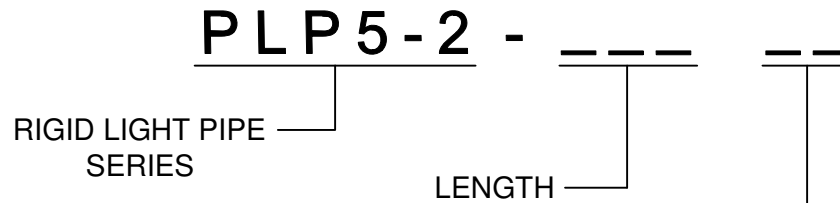

COLOR	Order Code
BLUE	BE
BLACK	BK
GREEN	GN
GRAY	GY
RED	RD
YELLOW	YW

NOTE: LEAVE ORDER CODE BLANK IF NO COLOR IS DESIRED.

3. PARTS ARE DYED TO COLOR UPON REQUEST.

STANDARD TOLERANCE (UNLESS OTHERWISE SPECIFIED) DECIMALS ANGULAR		 4 THOMAS, IRVINE, CA. 92618 TEL: (949) 951-8808 FAX: (949) 951-3974	
DESIGNED: K. Aukshunas			
		CHECKED: J. Chiang	DATE: 01/22/16
		CAGE CODE : 32559	SHEET # 2 OF 2
CAD GENERATED DOCUMENT. DO NOT MEASURE DRAWING.			