

Chipsmall Limited consists of a professional team with an average of over 10 year of expertise in the distribution of electronic components. Based in Hongkong, we have already established firm and mutual-benefit business relationships with customers from,Europe,America and south Asia,supplying obsolete and hard-to-find components to meet their specific needs.

With the principle of “Quality Parts,Customers Priority,Honest Operation,and Considerate Service”,our business mainly focus on the distribution of electronic components. Line cards we deal with include Microchip,ALPS,ROHM,Xilinx,Pulse,ON,Everlight and Freescale. Main products comprise IC,Modules,Potentiometer,IC Socket,Relay,Connector.Our parts cover such applications as commercial,industrial, and automotives areas.

We are looking forward to setting up business relationship with you and hope to provide you with the best service and solution. Let us make a better world for our industry!



Contact us

Tel: +86-755-8981 8866 Fax: +86-755-8427 6832

Email & Skype: info@chipsmall.com Web: www.chipsmall.com

Address: A1208, Overseas Decoration Building, #122 Zhenhua RD., Futian, Shenzhen, China

Model No: PLS-75F25AL01-08

Rev: 1

Product Line: Tymphany

Last Update: 2017-04-21 12:39:42

Product Description

This 3 inch 8 ohm member of the PLS family sets a high standard for compact full range drivers intended for applications such as television soundbars and compact music systems. Design features in this family include a stiff steel basket with venting under the spider to aid cooling of the motor, a ferrite magnet motor with copper cap to lower coil inductance, providing low distortion at low frequencies and extended high frequency response. A black anodized aluminium cone is employed, along with a black anodized aluminium dust cap coupled directly to the voice coil. Additionally, the cones come equipped with special-designed large roll rubber surrounds, which allow for a dynamic linear response at high excursion.



Mechanical Drawing

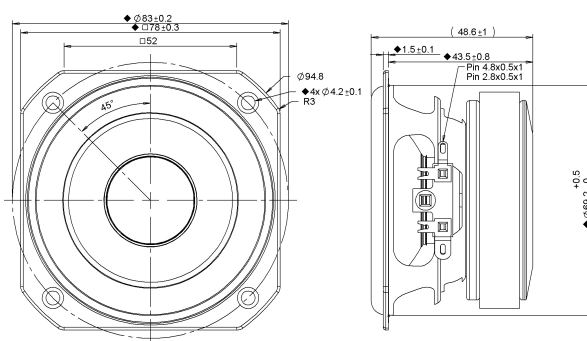

Specifications

DC Resistance	Revc	Ohms	6.21	5.0%	Energy Bandwidth Product	EBP	(1/Qes)*fs
Minimum Impedance	Zmin	Ohms	7.34	7.5%	Moving Mass	Mms	g
Voice Coil Inductance	Le	mH	0.05		Suspension Compliance	Cms	um/N
Resonant Frequency	Fs	Hz	99.51	15%	Effective Cone diameter	D	cm
Mechanical Q Factor	Qms		5.39		Effective Piston Area	Sd	cm ²
Electrical Q Factor	Qes		0.76		Effective Volume	Vas	L
Total Q Factor	Qts		0.67		Motor Force Factor	BL	Tm
Ratio Fs/Qts	F	Fs/Qts	149.63		Motor Efficiency Factor	β	(T*M ²)/Ohms
Half Space Sensitivity @2.83V	db@2.83V/1M	dB	84.43	+/- 1.0db	Voice coil former Material	VCfm	ASV
Half Space Sensitivity @1W/1M	db@1W/1M	dB	84.1	+/- 1.0db	Voice coil inner diameter	VCd	mm
Gap Height	Gh	mm	4		Rated Noise Power	P	W
Maximum Linear Excursion	Xmax	mm	2.1		Test Spectrum Bandwidth		100Hz~20KHz
Ferrofluid Type	FF				Driver Size	Inch	3 in
Driver Mass	Kg		0.38				

Frequency and Impedance Response

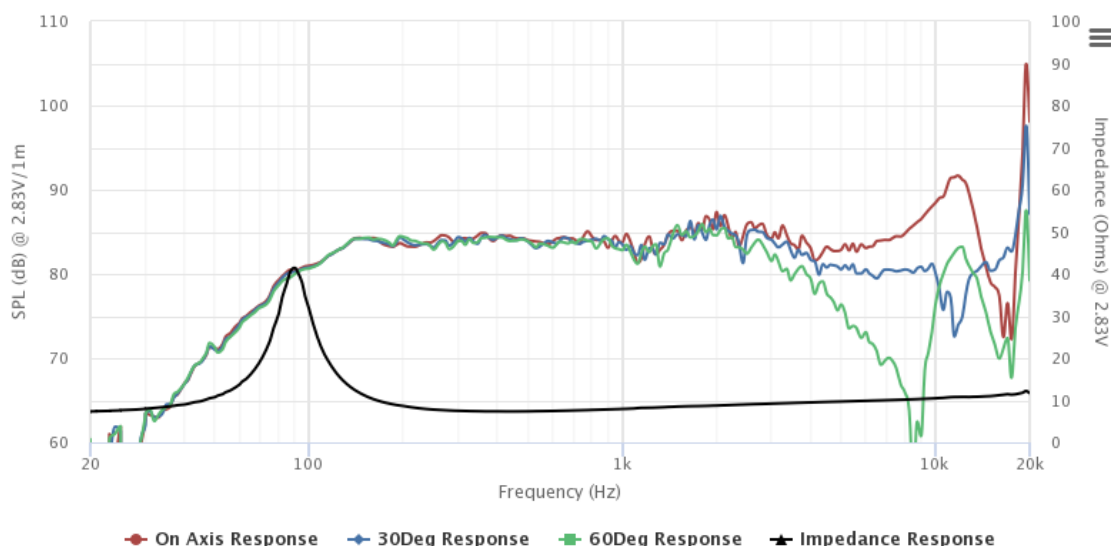

Highcharts.com