



Chipsmall Limited consists of a professional team with an average of over 10 year of expertise in the distribution of electronic components. Based in Hongkong, we have already established firm and mutual-benefit business relationships with customers from,Europe,America and south Asia,supplying obsolete and hard-to-find components to meet their specific needs.

With the principle of “Quality Parts,Customers Priority,Honest Operation,and Considerate Service”,our business mainly focus on the distribution of electronic components. Line cards we deal with include Microchip,ALPS,ROHM,Xilinx,Pulse,ON,Everlight and Freescale. Main products comprise IC,Modules,Potentiometer,IC Socket,Relay,Connector.Our parts cover such applications as commercial,industrial, and automotives areas.

We are looking forward to setting up business relationship with you and hope to provide you with the best service and solution. Let us make a better world for our industry!



## Contact us

Tel: +86-755-8981 8866 Fax: +86-755-8427 6832

Email & Skype: info@chipsmall.com Web: www.chipsmall.com

Address: A1208, Overseas Decoration Building, #122 Zhenhua RD., Futian, Shenzhen, China





**RoHS Directive compatibility information**  
<http://www.nais-e.com/>

**Features**

**1. Economic pricing that promptly reflects market demands**

Remarkable economic pricing is implemented in pursuit of cost performance.

**2. Output contacts switchable between timed out 2C and timed out 1C/Instantaneous 1C**

The timed out 1C/Instantaneous 1C output contact enables the efficient addition of self-maintenance circuits.

**3. 4 different time ranges selectable on a single unit**

Five types of timers cover the full range of time settings from 1 second to 30 hours.

**4. Equipped with zero-setting instantaneous output**

Set the dial all the way to "0" for instantaneous operation, so circuit testing can be easily accomplished.

**5. Compliant with UL, c-UL and CE.**

**Product types**

| Type                                | //////  | Contact arrangement   | Time range                                      | Operating voltage | Part No.           |
|-------------------------------------|---|---|---|-------------------|--------------------|
| PM4S<br>Multi-range Timer<br>A type | Power<br>ON-delay                               | T.D.:<br>Timed-out 2C<br>INST.:<br>Timed-out 1C<br>Instantaneous 1C<br>(Selected by front switch) | 1s/10s/1min/10min<br>(4 time ranges selectable) | 100 to 120V AC    | PM4S-A2C10M-AC120V |
|                                     |   |   |   | 200 to 240V AC    | PM4S-A2C10M-AC240V |
|                                     |   |   |   | 12V DC            | PM4S-A2C10M-DC12V  |
|                                     |   |   |   | 24V DC            | PM4S-A2C10M-DC24V  |
| PM4S<br>Multi-range Timer<br>B type |   |   | 3s/30s/3min/30min<br>(4 time ranges selectable) | 100 to 120V AC    | PM4S-A2C30M-AC120V |
|                                     |   |   |   | 200 to 240V AC    | PM4S-A2C30M-AC240V |
|                                     |   |   |   | 12V DC            | PM4S-A2C30M-DC12V  |
|                                     |   |   |   | 24V DC            | PM4S-A2C30M-DC24V  |
| PM4S<br>Multi-range Timer<br>C type |   |   | 6s/60s/6min/60min<br>(4 time ranges selectable) | 100 to 120V AC    | PM4S-A2C60M-AC120V |
|                                     |   |   |   | 200 to 240V AC    | PM4S-A2C60M-AC240V |
|                                     |   |   |   | 12V DC            | PM4S-A2C60M-DC12V  |
|                                     |   |   |   | 24V DC            | PM4S-A2C60M-DC24V  |
| PM4S<br>Multi-range Timer<br>D type | 1min/10min/1h/10h<br>(4 time ranges selectable) | 100 to 120V AC  | PM4S-A2C10H-AC120V                              |                   |                    |
|                                     |   | 200 to 240V AC  | PM4S-A2C10H-AC240V                              |                   |                    |
|                                     |   | 12V DC  | PM4S-A2C10H-DC12V                               |                   |                    |
|                                     |   | 24V DC  | PM4S-A2C10H-DC24V                               |                   |                    |
| PM4S<br>Multi-range Timer<br>E type | 3min/30min/3h/30h<br>(4 time ranges selectable) | 100 to 120V AC  | PM4S-A2C30H-AC120V                              |                   |                    |
|                                     |   | 200 to 240V AC  | PM4S-A2C30H-AC240V                              |                   |                    |
|                                     |   | 12V DC  | PM4S-A2C30H-DC12V                               |                   |                    |
|                                     |   | 24V DC  | PM4S-A2C30H-DC24V                               |                   |                    |

**Parts name**

• The PM4S Multi-Range timer allows time units and output contacts to be selected via front switches.

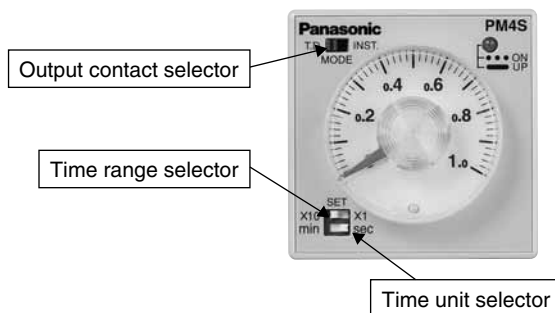

# PM4S

## Specifications

| Item                 |                                       | Type        | PM4S Multi-range Timer  |   |                |              |              |  |
|----------------------|---------------------------------------|-------------|---|---|----------------|--------------|--------------|--|
| Rating               | Rated operating voltage               |             | 100 to 120V AC  |   | 200 to 240V AC | 12V DC       | 24V DC       |  |
|                      | Rated frequency                       |             | 50/60 Hz  |   |                |              | —            |  |
|                      | Rated power consumption               |             | Approx. 3.0VA/3.6VA<br>(at 100V AC)<br>Approx. 4.5VA/5.25VA<br>(at 120V AC)   | Approx. 5.6VA/6.8VA<br>(at 200V AC)<br>Approx. 7.5VA/9.8VA<br>(at 240V AC)  | Approx. 1.3W   |              | Approx. 1.7W |  |
|                      | Output rating                         |             | 5A 250V AC (resistive load)   |   |                |              |              |  |
|                      | Operating mode                        |             | Power ON-delay  |   |                |              |              |  |
|                      | Time range                            | A type      |   | 1s/10s/1min/10min (4 time ranges selectable)  |                |              |              |  |
|                      |                                       | B type      |   | 3s/30s/3min/30min (4 time ranges selectable)  |                |              |              |  |
| C type               |                                       |             | 6s/60s/6min/60min (4 time ranges selectable)  |   |                |              |              |  |
| D type               |                                       |             | 1min/10min/1h/10h (4 time ranges selectable)  |   |                |              |              |  |
| E type               |                                       |             | 3min/30min/3h/30h (4 time ranges selectable)  |   |                |              |              |  |
| Time accuracy (Note) | Operating time fluctuation            |             | ±1% (power off time change at the range of 0.1s to 1h)  |   |                |              |              |  |
|                      | Setting error                         |             | ±5% (Full-scale value)  |   |                |              |              |  |
|                      | Voltage error                         |             | ±1% (at the operating voltage changes between 85 to 110%)   |   |                |              |              |  |
|                      | Temperature error                     |             | ±2% (at 20°C ambient temp. at the range of -10 to +50°C +14 to +122°F)  |   |                |              |              |  |
| Contact              | Contact arrangement                   |             | T.D.: Timed-out 2 Form C<br>INST.: Timed-out 1 Form C, instantaneous 1 Form C (Selected by front switch)  |   |                |              |              |  |
|                      | Contact resistance (Initial value)    |             | Max. 100mΩ (at 1A 6V DC)  |   |                |              |              |  |
|                      | Contact material                      |             | Silver alloy  |   |                |              |              |  |
| Life                 | Mechanical (contact)                  |             | Min. 10 <sup>7</sup>  |   |                |              |              |  |
|                      | Electrical (contact)                  |             | Min. 10 <sup>5</sup> (at rated control capacity)  |   |                |              |              |  |
| Electrical function  | Allowable operating voltage range     |             | 85 to 110% of rated operating voltage   |   |                |              |              |  |
|                      | Insulation resistance (Initial value) |             | Min. 100MΩ  | Between live and dead metal parts<br>Between input and output<br>Between contacts of different poles<br>Between contacts of same pole |                | (At 500V DC) |              |  |
|                      | Breakdown voltage (Initial value)     |             | 2,000Vrms for 1 min Between live and dead metal parts<br>2,000Vrms for 1 min Between input and output<br>2,000Vrms for 1 min Between contacts of different poles<br>1,000Vrms for 1 min Between contacts of same pole |   |                |              |              |  |
|                      | Min. power off time                   |             | 100 ms  |   |                |              |              |  |
|                      | Max. temperature rise                 |             | 55°C 131°F  |   |                |              |              |  |
| Mechanical function  | Vibration resistance                  | Functional  | 10 to 55Hz: 1 cycle/min double amplitude of 0.25mm (10min on 3 axes)  |   |                |              |              |  |
|                      |                                       | Destructive | 10 to 55Hz: 1 cycle/min double amplitude of 0.375mm (1h on 3 axes)  |   |                |              |              |  |
|                      | Shock resistance                      | Functional  | Min. 98m/s <sup>2</sup> (4 times on 3 axes)   |   |                |              |              |  |
|                      |                                       | Destructive | Min. 980m/s <sup>2</sup> (5 times on 3 axes)  |   |                |              |              |  |
| Operating condition  | Ambient temperature                   |             | -10 to +50°C +14 to +122°F  |   |                |              |              |  |
|                      | Ambient humidity                      |             | 30 to 85%RH (non-condensing)  |   |                |              |              |  |
|                      | Atmospheric pressure                  |             | 860 to 1,060hPa   |   |                |              |              |  |
|                      | Ripple factor (DC type)               |             | 20%   |   |                |              |              |  |
| Others               | Weight                                |             | Approximately 110 g 3.880 oz  |   |                |              |              |  |

Notes) 1. Unless otherwise specified, the measurement conditions at the maximum scale time standard are specified to be the rated operating voltage (within 5% ripple factor for DC), 20°C 68°F ambient temperature, and 1s power off time.

2. For the 1s range, the tolerance for each specification becomes ±10ms.

## Applicable standard

| Safety standard | EN61812-1   | Pollution Degree 2/Overvoltage Category III  |
|-----------------|---|--|
| EMC             | (EMI)EN61000-6-4<br>Radiation interference electric field strength<br>Noise terminal voltage<br>(EMS)EN61000-6-2<br>Static discharge immunity | EN55011 Group1 ClassA<br>EN55011 Group1 ClassA   |
|                 | RF electromagnetic field immunity   | EN61000-4-2 4 kV contact<br>8 kV air   |
|                 | EFT/B immunity  | EN61000-4-3 10 V/m AM modulation (80 MHz to 1 GHz)<br>10 V/m pulse modulation (895 MHz to 905 MHz)                                       |
|                 | Surge immunity  | EN61000-4-4 2 kV (power supply line)   |
|                 | Conductivity noise immunity   | EN61000-4-5 1 kV (power line)  |
|                 | Power frequency magnetic field immunity   | EN61000-4-6 10 V/m AM modulation (0.15 MHz to 80 MHz)  |
|                 | Voltage dip/Instantaneous stop/Voltage fluctuation immunity   | EN61000-4-8 30 A/m (50 Hz)   |
|                 |   | EN61000-4-11 10 ms, 30% (rated voltage)<br>100 ms, 60% (rated voltage)<br>1,000 ms, 60% (rated voltage)<br>5,000 ms, 95% (rated voltage) |

**Dimension** (Unit: mm inch) Tolerance:  $\pm 0.5 \pm .020$

• **Surface mount dimensions**

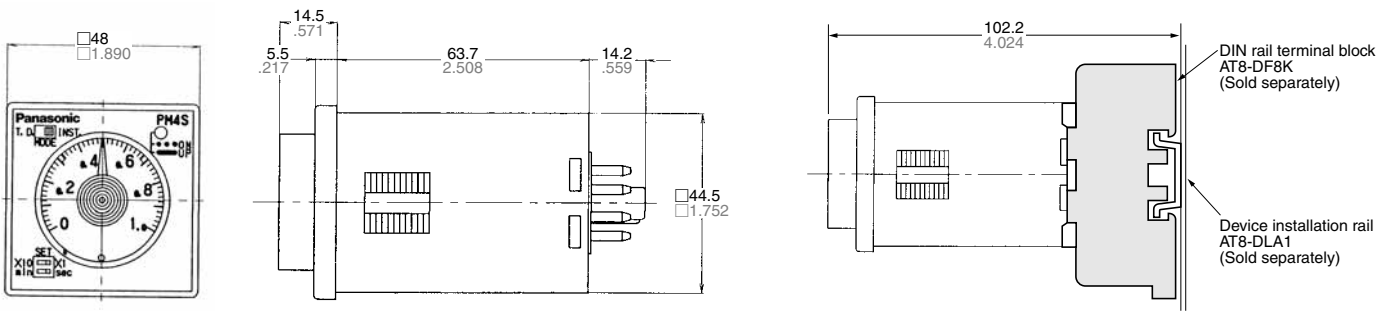

• **Panel mount dimensions (with mounting frame)**

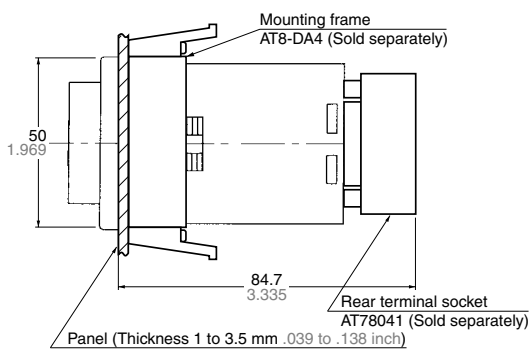

• **Panel cut out dimensions**

Standard cut out dimensions are shown below. Use mounting frame (AT8-DA4) and rubber gasket (ATC18002).

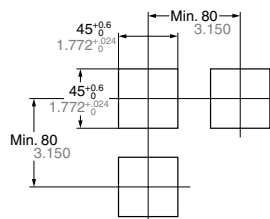

• **Adjacent mounting**

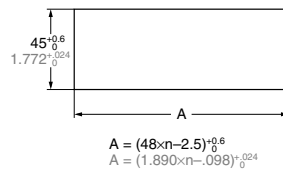

• **Terminal layouts and wiring diagrams**

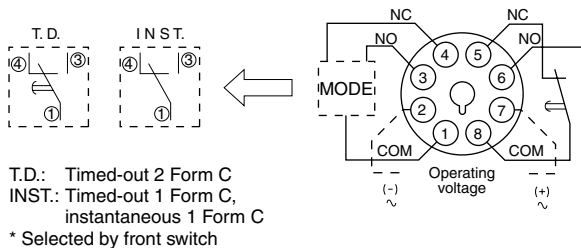

Notes:

- Operating voltage signs in parentheses ( ) indicate the polarity of the DC type.
- is a time delay contact.
- is an instantaneous contact.

**Operation mode**

1. **T.D. mode**

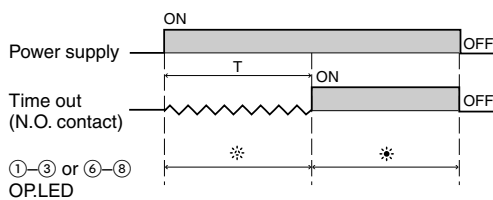

2. **INST. mode**

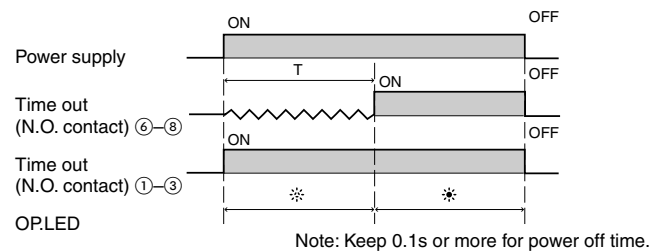

## Precautions during usage

1. Avoid locations subject to flammable or corrosive gases, excessive dust, oil, vibrations, or excessive shocks.
2. Since the main-unit is made of polycarbonate resin, avoid contact with or use in environments containing methyl alcohol, benzene, thinners, and other organic solvents; and ammonia, caustic sodas, and other alkaline substances.
3. **Power supply superimposed surge protector**

Although a surge protector will withstand standard-waveform voltage with the values in the next table, anything above this will destroy the internal circuit. You should therefore use a surge absorber.

|                    |                                    |
|--------------------|------------------------------------|
| 12 V DC<br>24 V DC | 100 to 120 V AC<br>200 to 240 V AC |
| 500 V              | 4,000 V                            |

- Surge waveform  
[ $\pm(1.2 \times 50) \mu\text{s}$  uni-polar full wave voltage]

4. In order to maintain the characteristics, do not remove the timer case.
5. When installing the panel, use the ATA4811 mounting frame (Sold separately).
6. If you change the operating voltage, be sure not to allow leak current into the timer.
7. Avoid leaving the unit powered continuously. Leaving the unit powered up with output set to ON continuously for a long period of time (about 1 month or more) will wear out the electronic components. If you will be keeping it powered continuously, combine with a relay to create the circuit shown below:

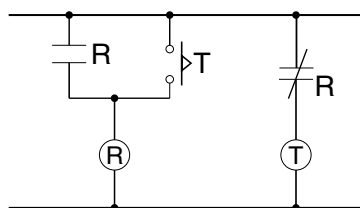

8. The timer setting dial should only be turned within the range indicated on the dial face. Turning it too far may break the stopper and cause damage to internal components.

## Acquisition of CE marking

Please abide by the conditions below when using in applications that comply with EN61812-1.

1. Overvoltage category III, pollution level 2
2. The load connected to the output contact should have basic insulation. This timer is protected with basic insulation and can be double-insulated to meet EN/IEC requirements by using basic insulation on the load.

3. Please use a power supply that is protected by an overcurrent protection device which complies with the EN/IEC standard (example: 250 V 1 A fuse, etc.).
4. You must use a terminal socket or socket for the installation. Do not touch the terminals or other parts of the timer when it is powered. When installing or un-installing, make sure that no voltage is being applied to any of the terminals.

5. Do not use this timer as a safety circuit. For example when using a timer in a heater circuit, etc., provide a protection circuit on the machine side.