



Chipsmall Limited consists of a professional team with an average of over 10 year of expertise in the distribution of electronic components. Based in Hongkong, we have already established firm and mutual-benefit business relationships with customers from,Europe,America and south Asia,supplying obsolete and hard-to-find components to meet their specific needs.

With the principle of "Quality Parts,Customers Priority,Honest Operation,and Considerate Service",our business mainly focus on the distribution of electronic components. Line cards we deal with include Microchip,ALPS,ROHM,Xilinx,Pulse,ON,Everlight and Freescale. Main products comprise IC,Modules,Potentiometer,IC Socket,Relay,Connector.Our parts cover such applications as commercial,industrial, and automotives areas.

We are looking forward to setting up business relationship with you and hope to provide you with the best service and solution. Let us make a better world for our industry!



Contact us

Tel: +86-755-8981 8866 Fax: +86-755-8427 6832

Email & Skype: info@chipsmall.com Web: www.chipsmall.com

Address: A1208, Overseas Decoration Building, #122 Zhenhua RD., Futian, Shenzhen, China



PM50RLA060

FLAT-BASE TYPE
INSULATED PACKAGE

PM50RLA060



FEATURE

- a) Adopting new 5th generation IGBT (CSTBT) chip, which performance is improved by 1μm fine rule process.
For example, typical $V_{ce(sat)}=1.5V @T_j=125^{\circ}C$
- b) I adopt the over-temperature conservation by T_j detection of CSTBT chip, and error output is possible from all each conservation upper and lower arm of IPM.
- c) New small package
Reduce the package size by 10%, thickness by 22% from S-DASH series.
- d) Current rating of brake part increased.
60% for the current rating of inverter part.
 - 3φ 50A, 600V Current-sense IGBT type inverter
 - 30A, 600V Current-sense regenerative brake IGBT
 - Monolithic gate drive & protection logic
 - Detection, protection & status indication circuits for, short-circuit, over-temperature & under-voltage (P-Fo available from upper arm devices)
 - Acoustic noise-less 3.7kW class inverter application
 - UL Recognized Yellow Card No.E80276(N)
File No.E80271

APPLICATION

General purpose inverter, servo drives and other motor controls

PACKAGE OUTLINES

Dimensions in mm

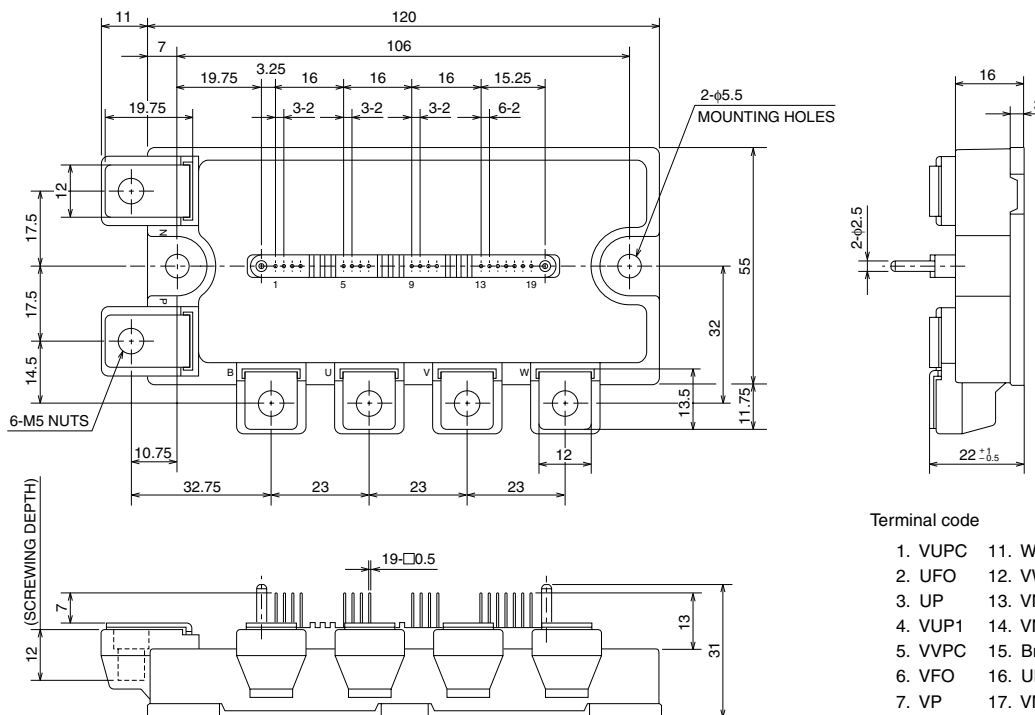

Terminal code

- | | |
|---------|----------|
| 1. VUPC | 11. WP |
| 2. UFO | 12. VVP1 |
| 3. UP | 13. VNC |
| 4. VUP1 | 14. VN1 |
| 5. VVPC | 15. Br |
| 6. VFO | 16. UN |
| 7. VP | 17. VN |
| 8. VVP1 | 18. WN |
| 9. VWPC | 19. Fo |
| 10. WFO | |

PM50RLA060

FLAT-BASE TYPE
INSULATED PACKAGE

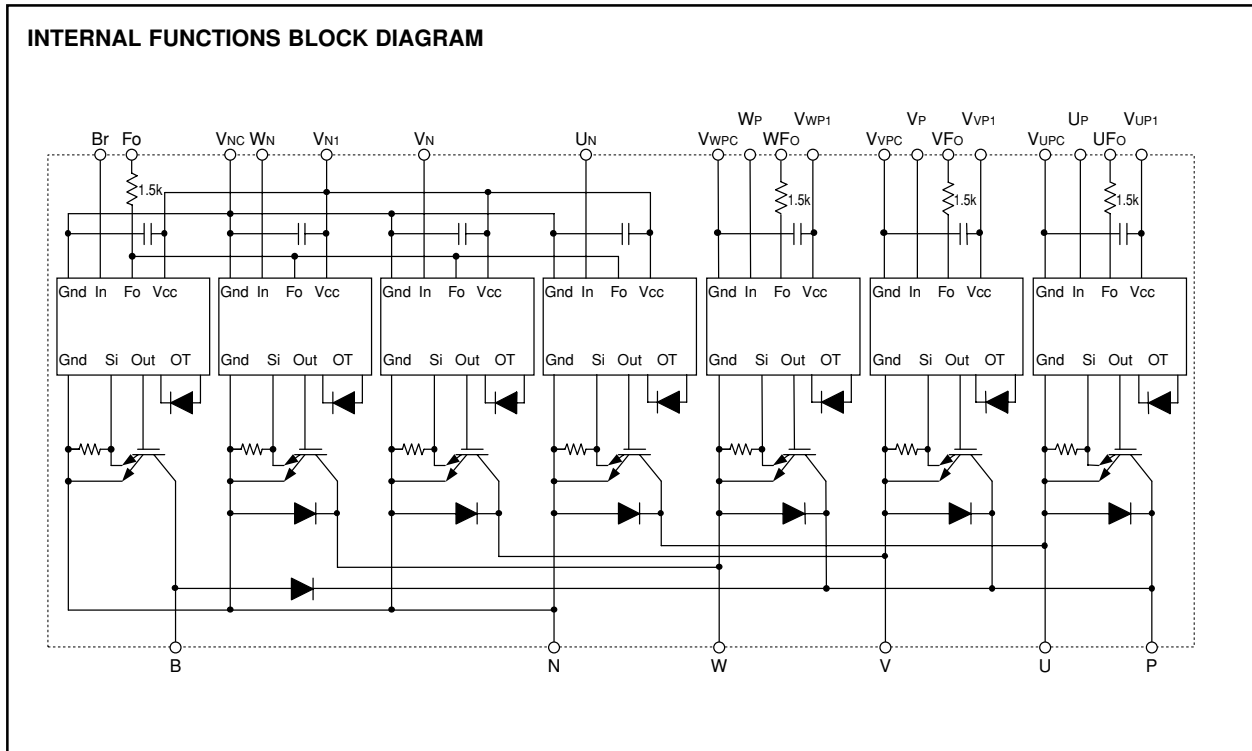

MAXIMUM RATINGS (T_j = 25°C, unless otherwise noted)

INVERTER PART

Symbol	Parameter	Condition	Ratings	Unit
V _{CES}	Collector-Emitter Voltage	V _D = 15V, V _{CIN} = 15V	600	V
±I _C	Collector Current	T _C = 25°C	50	A
±I _{CP}	Collector Current (Peak)	T _C = 25°C	100	A
P _C	Collector Dissipation	T _C = 25°C (Note-1)	131	W
T _j	Junction Temperature		-20 ~ +150	°C

BRAKE PART

Symbol	Parameter	Condition	Ratings	Unit
V _{CES}	Collector-Emitter Voltage	V _D = 15V, V _{CIN} = 15V	600	V
I _C	Collector Current	T _C = 25°C	30	A
I _{CP}	Collector Current (Peak)	T _C = 25°C	60	A
P _C	Collector Dissipation	T _C = 25°C (Note-1)	103	W
V _{R(DC)}	FWDi Rated DC Reverse Voltage	T _C = 25°C	600	V
I _F	FWDi Forward Current	T _C = 25°C	30	A
T _j	Junction Temperature		-20 ~ +150	°C

CONTROL PART

Symbol	Parameter	Condition	Ratings	Unit
V _D	Supply Voltage	Applied between : V _{UP1} -V _{UPC} V _{VPC} -V _{VPC} , V _{WP1} -V _{WPC} , V _{N1} -V _N	20	V
V _{CIN}	Input Voltage	Applied between : U _P -V _{UPC} , V _P -V _{VPC} W _P -V _{WPC} , U _N • V _N • W _N • B _r -V _N	20	V
V _{F0}	Fault Output Supply Voltage	Applied between : U _{F0} -V _{UPC} , V _{F0} -V _{VPC} , W _{F0} -V _{WPC} F ₀ -V _N	20	V
I _{F0}	Fault Output Current	Sink current at U _{F0} , V _{F0} , W _{F0} , F ₀ terminals	20	mA

PM50RLA060

FLAT-BASE TYPE
INSULATED PACKAGE

TOTAL SYSTEM

Symbol	Parameter	Condition	Ratings	Unit
VCC(PROT)	Supply Voltage Protected by SC	V _D = 13.5 ~ 16.5V, Inverter Part, T _j = +125°C Start	400	V
VCC(surge)	Supply Voltage (Surge)	Applied between : P-N, Surge value	500	V
T _{stg}	Storage Temperature		-40 ~ +125	°C
V _{iso}	Isolation Voltage	60Hz, Sinusoidal, Charged part to Base, AC 1 min.	2500	V _{rms}

THERMAL RESISTANCES

Symbol	Parameter	Condition	Limits			Unit
			Min.	Typ.	Max.	
R _{th(j-c)Q}	Junction to case Thermal Resistances	Inverter IGBT (per 1 element) (Note-1)	—	—	0.95*	°C/W
R _{th(j-c)F}		Inverter FWDi (per 1 element) (Note-1)	—	—	1.61*	
R _{th(j-c)Q}		Brake IGBT (Note-1)	—	—	1.21*	
R _{th(j-c)F}		Brake FWDi (Note-1)	—	—	2.19*	
R _{th(c-f)}	Contact Thermal Resistance	Case to fin, (per 1 module) Thermal grease applied (Note-1)	—	—	0.038	

* If you use this value, R_{th(f-a)} should be measured just under the chips.

(Note-1) T_c (under the chip) measurement point is below.

(unit : mm)

axis	arm		UP		VP		WP		UN		VN		WN		Br	
	IGBT	FWDi	IGBT	FWDi	IGBT	FWDi	IGBT	FWDi	IGBT	FWDi	IGBT	FWDi	IGBT	FWDi	IGBT	FWDi
X	29.0	29.5	64.6	65.1	85.9	86.4	38.1	37.6	54.8	55.3	76.1	75.6	18.3	22.4		
Y	-7.3	1.6	-7.3	2.1	-7.3	2.1	5.3	-4.6	5.3	-4.6	5.3	-4.6	-7.4	7.0		

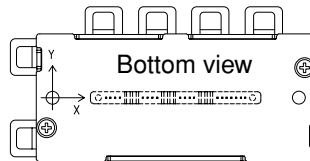

ELECTRICAL CHARACTERISTICS (T_j = 25°C, unless otherwise noted)

INVERTER PART

Symbol	Parameter	Condition	Limits			Unit	
			Min.	Typ.	Max.		
V _{CE(sat)}	Collector-Emitter Saturation Voltage	V _D = 15V, I _C = 50A V _{CIN} = 0V (Fig. 1)	T _j = 25°C	—	1.6	2.1	V
			T _j = 125°C	—	1.5	2.0	
V _{EC}	FWDi Forward Voltage	-I _C = 50A, V _D = 15V, V _{CIN} = 15V (Fig. 2)	—	2.2	3.3	V	
t _{on}	Switching Time	V _D = 15V, V _{CIN} = 0V↔15V V _{CC} = 300V, I _C = 50A T _j = 125°C Inductive Load (Fig. 3,4)	0.5	1.0	2.4	μs	
t _{tr}			—	0.2	0.4		
t _{c(on)}			—	0.4	1.0		
t _{off}			—	1.2	2.5		
t _{c(off)}			—	0.5	1.0		
I _{CES}	Collector-Emitter Cutoff Current	V _{CE} = V _{CES} , V _{CIN} = 15V (Fig. 5)	T _j = 25°C	—	—	1	mA
			T _j = 125°C	—	—	10	

PM50RLA060

FLAT-BASE TYPE
INSULATED PACKAGE

BRAKE PART

Symbol	Parameter	Condition	Limits			Unit	
			Min.	Typ.	Max.		
V _{CE(sat)}	Collector-Emitter Saturation Voltage	V _D = 15V, I _C = 30A V _{CIN} = 0V (Fig. 1)	T _J = 25°C	—	1.6	2.1	V
			T _J = 125°C	—	1.5	2.0	
V _{FM}	FWDi Forward Voltage	I _F = 30A (Fig. 2)	—	2.2	3.3	V	
I _{CES}	Collector-Emitter Cutoff Current	V _{CE} = V _{CES} , V _{CIN} = 15V (Fig. 5)	T _J = 25°C	—	—	1	mA
			T _J = 125°C	—	—	10	

CONTROL PART

Symbol	Parameter	Condition	Limits			Unit	
			Min.	Typ.	Max.		
I _D	Circuit Current	V _D = 15V, V _{CIN} = 15V	V _{N1-VNC}	—	20	30	mA
			V _{P1-VPC}	—	5	10	
V _{th(ON)}	Input ON Threshold Voltage	Applied between : UP-VUPC, VP-VVPC, WP-VWPC UN • VN • WN • Br-VNC	1.2	1.5	1.8	V	
V _{th(OFF)}	Input OFF Threshold Voltage		1.7	2.0	2.3		
SC	Short Circuit Trip Level	-20 ≤ T _J ≤ 125°C, V _D = 15V (Fig. 3,6)	Inverter part	100	—	—	A
			Brake part	60	—	—	
t _{off(SC)}	Short Circuit Current Delay Time	V _D = 15V (Fig. 3,6)	—	0.2	—	μs	
OT	Over Temperature Protection	V _D = 15V Detect T _J of IGBT chip	Trip level	135	145	—	°C
			Reset level	—	125	—	
UV	Supply Circuit Under-Voltage Protection	-20 ≤ T _J ≤ 125°C	Trip level	11.5	12.0	12.5	V
			Reset level	—	12.5	—	
I _{FO(H)}	Fault Output Current	V _D = 15V, V _{FO} = 15V (Note-2)	—	—	0.01	mA	
I _{FO(L)}			—	10	15		
t _{FO}	Minimum Fault Output Pulse Width	V _D = 15V (Note-2)	1.0	1.8	—	ms	

(Note-2) Fault output is given only when the internal SC, OT & UV protections schemes of either upper or lower arm device operate to protect it.

MECHANICAL RATINGS AND CHARACTERISTICS

Symbol	Parameter	Condition	Limits			Unit
			Min.	Typ.	Max.	
—	Mounting torque	Main terminal screw : M5	2.5	3.0	3.5	N • m
—	Mounting torque	Mounting part screw : M5	2.5	3.0	3.5	N • m
—	Weight	—	—	380	—	g

RECOMMENDED CONDITIONS FOR USE

Symbol	Parameter	Condition	Recommended value	Unit
V _{CC}	Supply Voltage	Applied across P-N terminals	≤ 400	V
V _D	Control Supply Voltage	Applied between : V _{UP1-VUPC} , V _{VP1-VVPC} V _{WP1-VWPC} , V _{N1-VNC} (Note-3)	15 ± 1.5	V
V _{CIN(ON)}	Input ON Voltage	Applied between : UP-VUPC, VP-VVPC, WP-VWPC UN • VN • WN • Br-VNC	≤ 0.8	V
V _{CIN(OFF)}	Input OFF Voltage		≥ 9.0	
f _{PWM}	PWM Input Frequency	Using Application Circuit of Fig. 8	≤ 20	kHz
t _{dead}	Arm Shoot-through Blocking Time	For IPM's each input signals (Fig. 7)	≥ 2.0	μs

(Note-3) With ripple satisfying the following conditions: dv/dt swing ≤ ±5V/μs, Variation ≤ 2V peak to peak

PM50RLA060

FLAT-BASE TYPE
INSULATED PACKAGE

PRECAUTIONS FOR TESTING

1. Before applying any control supply voltage (V_D), the input terminals should be pulled up by resistors, etc. to their corresponding supply voltage and each input signal should be kept off state.
After this, the specified ON and OFF level setting for each input signal should be done.
2. When performing "SC" tests, the turn-off surge voltage spike at the corresponding protection operation should not be allowed to rise above V_{CES} rating of the device.
(These test should not be done by using a curve tracer or its equivalent.)

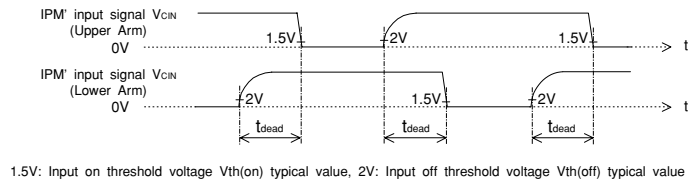
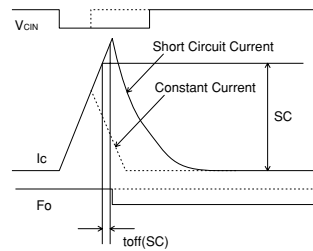
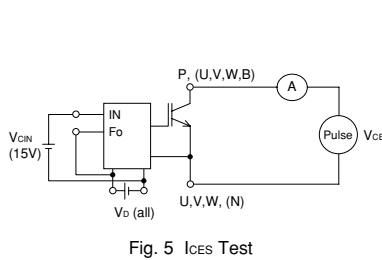
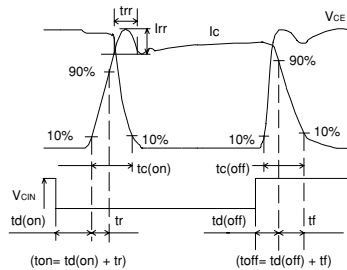
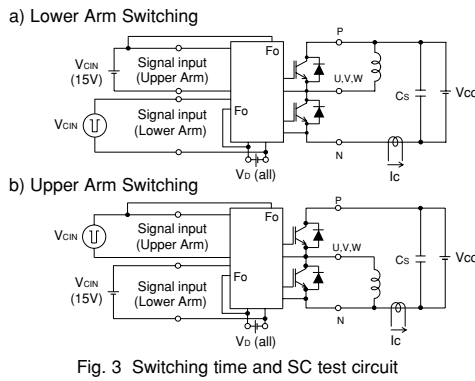
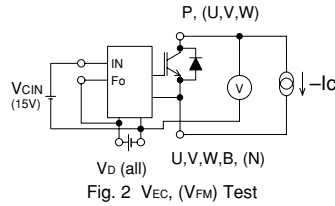
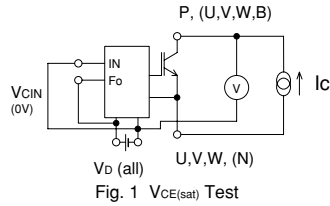

PM50RLA060

FLAT-BASE TYPE
INSULATED PACKAGE

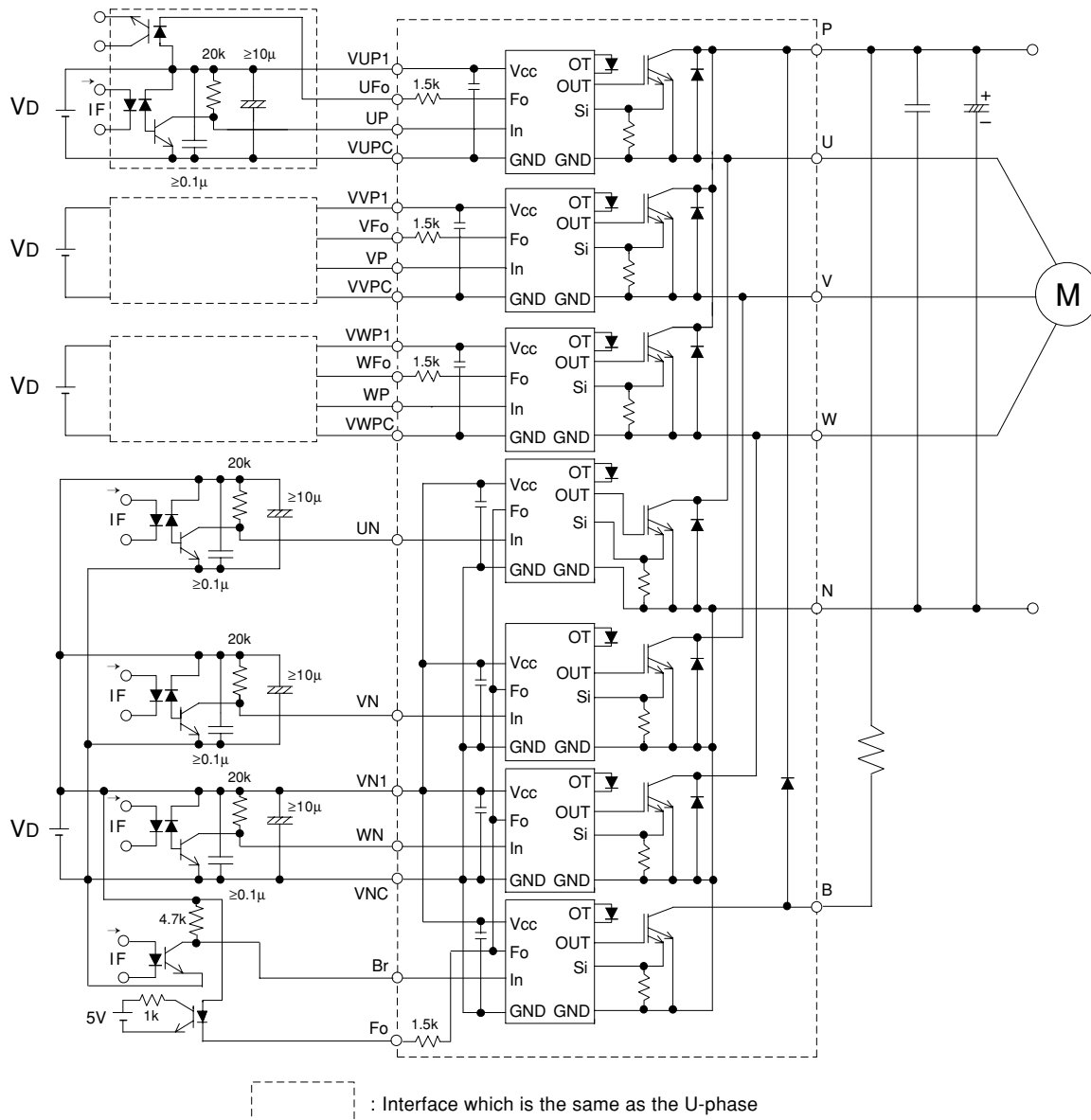

Fig. 8 Application Example Circuit

NOTES FOR STABLE AND SAFE OPERATION ;

- Design the PCB pattern to minimize wiring length between opto-coupler and IPM's input terminal, and also to minimize the stray capacity between the input and output wirings of opto-coupler.
- Connect low impedance capacitor between the Vcc and GND terminal of each fast switching opto-coupler.
- Fast switching opto-couplers: t_{PLH} , $t_{PHL} \leq 0.8\mu s$, Use High CMR type.
- Slow switching opto-coupler: CTR > 100%
- Use 4 isolated control power supplies (VD). Also, care should be taken to minimize the instantaneous voltage charge of the power supply.
- Make inductance of DC bus line as small as possible, and minimize surge voltage using snubber capacitor between P and N terminal.
- Use line noise filter capacitor (ex. 4.7nF) between each input AC line and ground to reject common-mode noise from AC line and improve noise immunity of the system.

PM50RLA060

FLAT-BASE TYPE
INSULATED PACKAGE

PERFORMANCE CURVES

OUTPUT CHARACTERISTICS
(INVERTER PART - TYPICAL)

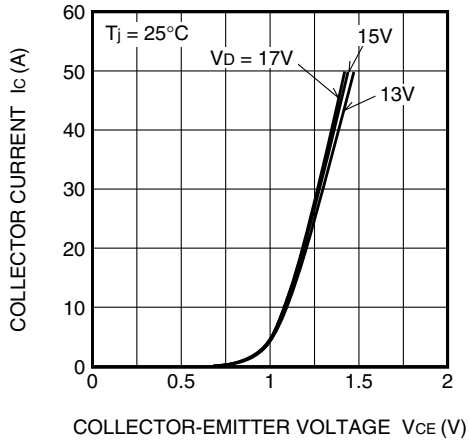

COLLECTOR-EMITTER SATURATION
VOLTAGE (VS. I_c) CHARACTERISTICS
(INVERTER PART - TYPICAL)

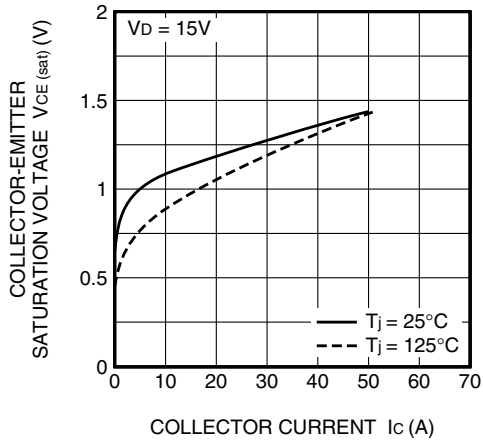

COLLECTOR-EMITTER SATURATION
VOLTAGE (VS. V_D) CHARACTERISTICS
(INVERTER PART - TYPICAL)

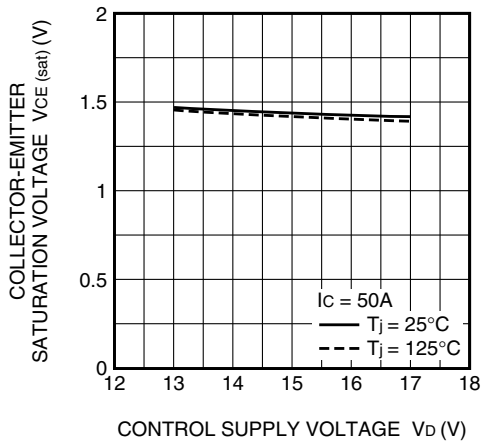

SWITCHING TIME CHARACTERISTICS
(TYPICAL)

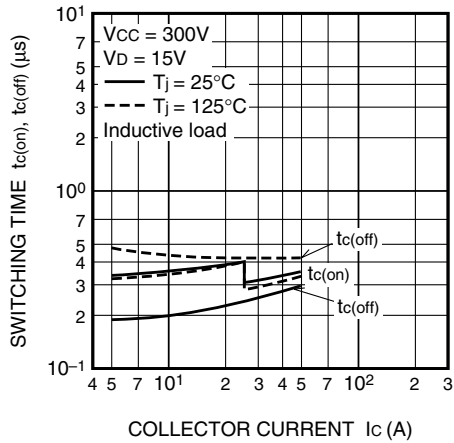

SWITCHING TIME CHARACTERISTICS
(TYPICAL)

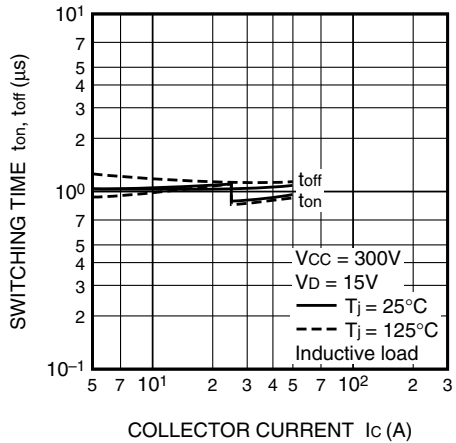

SWITCHING LOSS CHARACTERISTICS
(TYPICAL)

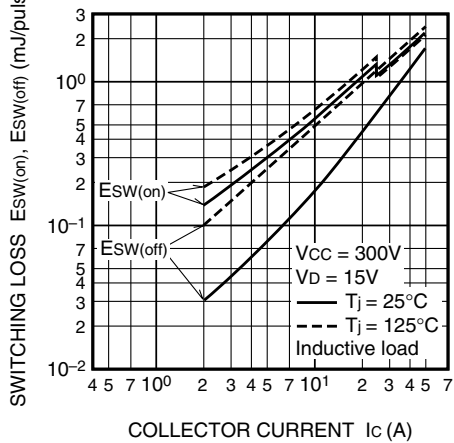

PM50RLA060

FLAT-BASE TYPE
INSULATED PACKAGE

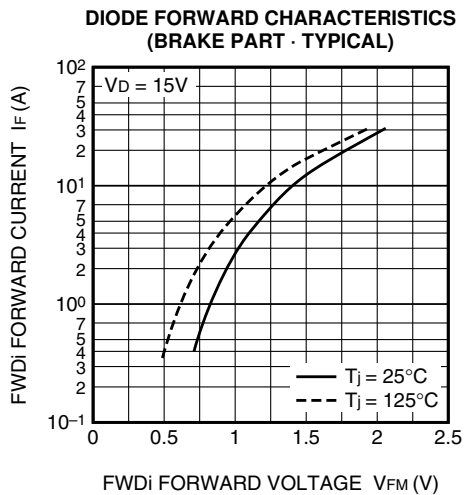
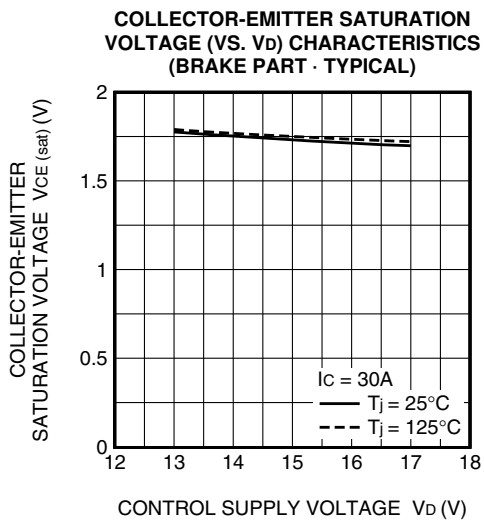
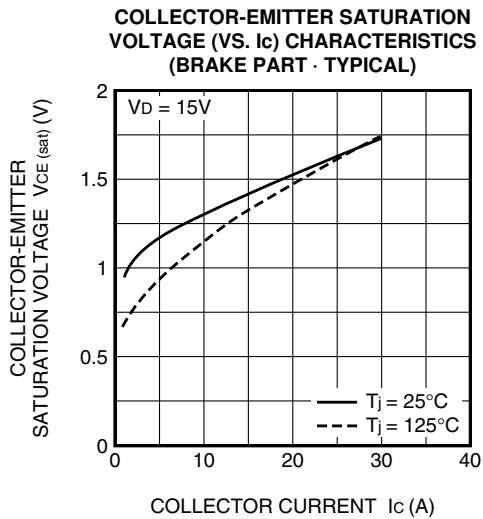
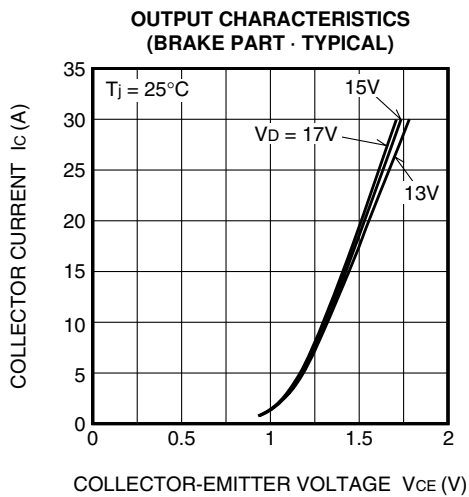
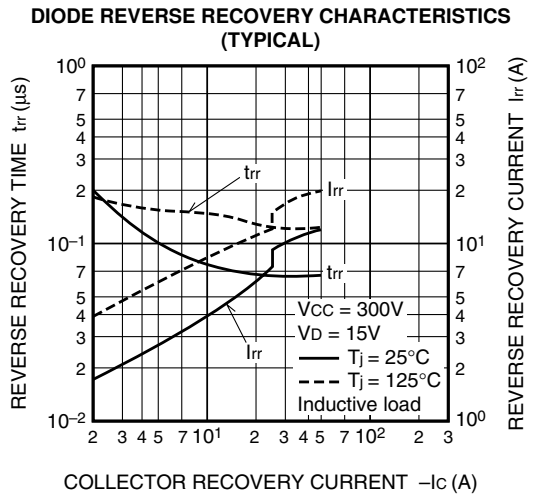
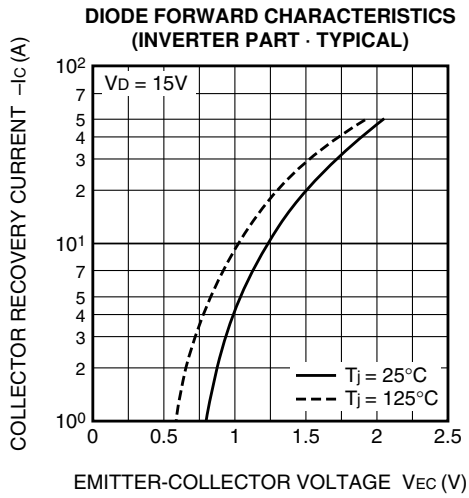

PM50RLA060

FLAT-BASE TYPE
INSULATED PACKAGE

**Id VS. fc CHARACTERISTICS
(TYPICAL)**

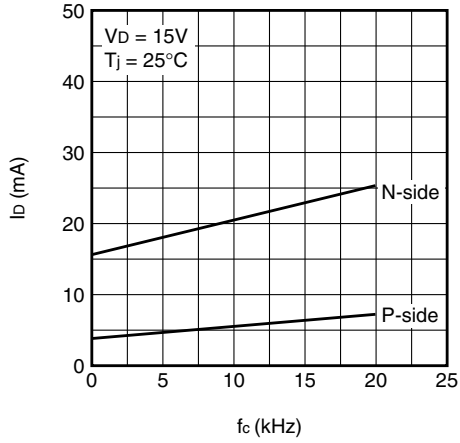

**TRANSIENT THERMAL IMPEDANCE CHARACTERISTICS
(INVERTER PART)**

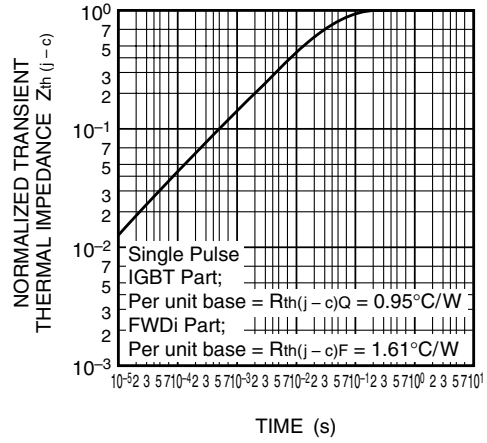

**TRANSIENT THERMAL IMPEDANCE CHARACTERISTICS
(BRAKE PART)**

