



Chipsmall Limited consists of a professional team with an average of over 10 year of expertise in the distribution of electronic components. Based in Hongkong, we have already established firm and mutual-benefit business relationships with customers from,Europe,America and south Asia,supplying obsolete and hard-to-find components to meet their specific needs.

With the principle of “Quality Parts,Customers Priority,Honest Operation,and Considerate Service”,our business mainly focus on the distribution of electronic components. Line cards we deal with include Microchip,ALPS,ROHM,Xilinx,Pulse,ON,Everlight and Freescale. Main products comprise IC,Modules,Potentiometer,IC Socket,Relay,Connector.Our parts cover such applications as commercial,industrial, and automotives areas.

We are looking forward to setting up business relationship with you and hope to provide you with the best service and solution. Let us make a better world for our industry!



Contact us

Tel: +86-755-8981 8866 Fax: +86-755-8427 6832

Email & Skype: info@chipsmall.com Web: www.chipsmall.com

Address: A1208, Overseas Decoration Building, #122 Zhenhua RD., Futian, Shenzhen, China



Core **PM62/49**

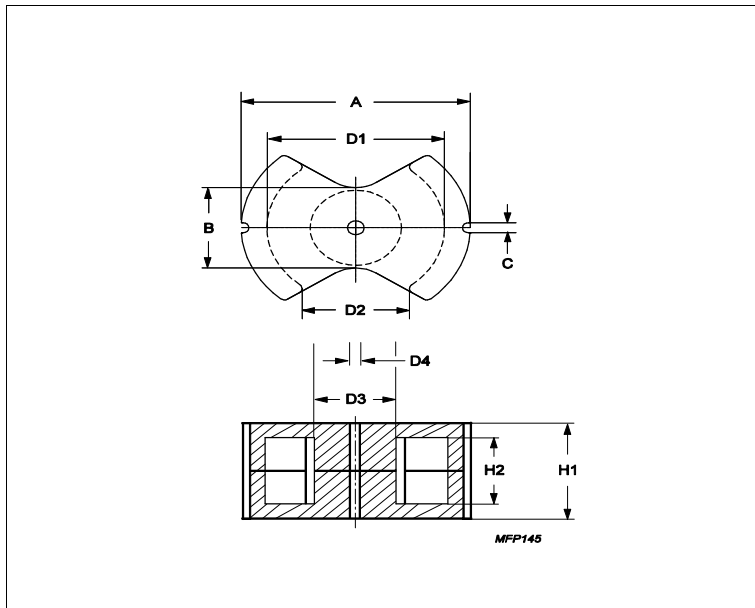

Effective parameters				
	Parameter	Value	Unit	
	$\Sigma(I/A)$	core factor (C1)	0.191	mm ⁻¹
	Ve	effective volume	62000	mm ³
	Le	effective length	109	mm
	Ae	effective area	570	mm ²
	Amin	minimum area	470	mm ²
	m	PM62/49	≈ 280	g/set

Dimensions for product: PM62/49						
	Nom	Tol +	Tol -	Max	Min	Unit
A	62.00	0.00	2.00	62.00	60.00	mm
B				28.50		mm
C	4.00	1.00	0.00	5.00	4.00	mm
D1	48.80	1.50	0.00	50.30	48.80	mm
D2					29.00	mm
D3	25.50	0.00	0.80	25.50	24.70	mm
D4	5.40	0.20	0.00	5.60	5.40	mm
H1	49.00	0.00	0.40	49.00	48.60	mm
H2	33.40	0.80	0.00	34.20	33.40	mm

Inductance factor				
Material	Value	Tol +	Tol -	Unit
3C94	12000	25%	25%	nH/turns ²

Power loss: 3C94				
Measuring conditions			Max	Unit
100 kHz	200 mT	100 °C	34.000	W/set

Bsat					
Measuring conditions			Material	Min	Unit
25 kHz	250 A/m	100 °C	3C94	320	mT