

Chipsmall Limited consists of a professional team with an average of over 10 year of expertise in the distribution of electronic components. Based in Hongkong, we have already established firm and mutual-benefit business relationships with customers from,Europe,America and south Asia,supplying obsolete and hard-to-find components to meet their specific needs.

With the principle of “Quality Parts,Customers Priority,Honest Operation,and Considerate Service”,our business mainly focus on the distribution of electronic components. Line cards we deal with include Microchip,ALPS,ROHM,Xilinx,Pulse,ON,Everlight and Freescale. Main products comprise IC,Modules,Potentiometer,IC Socket,Relay,Connector.Our parts cover such applications as commercial,industrial, and automotives areas.

We are looking forward to setting up business relationship with you and hope to provide you with the best service and solution. Let us make a better world for our industry!



Contact us

Tel: +86-755-8981 8866 Fax: +86-755-8427 6832

Email & Skype: info@chipsmall.com Web: www.chipsmall.com

Address: A1208, Overseas Decoration Building, #122 Zhenhua RD., Futian, Shenzhen, China

PMC15

PMC 15 E -1 -□

① ② ③ ④ ⑤



RoHS

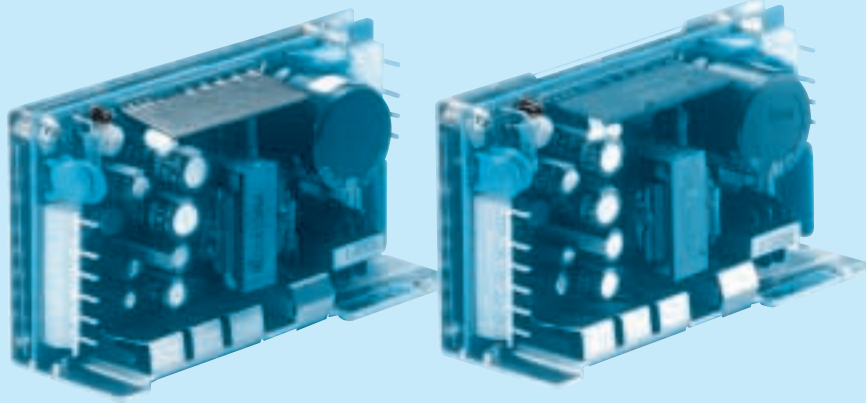

- ① Series name
- ② Output wattage
- ③ UL recognized, TÜV approved, CSA certified : E
- ④ Output voltage combination
- ⑤ Optional *1
C :with Coating
G :Low leakage current

PMC

MODEL		PMC15E-1	PMC15E-2	PMC15E-3
DC OUTPUT	V1	+5V 2.0A	+5V 2.0A	+5V 2.0A
	V2	+12V 0.3A	+15V 0.3A	+12V 0.3A
	V3	-12V 0.2A	-15V 0.2A	-5V 0.2A

SPECIFICATIONS

	MODEL	PMC15E-1	PMC15E-2	PMC15E-3							
INPUT	VOLTAGE[V]	AC85 - 264 1 φ or DC110 - 370									
	CURRENT[A]	ACIN 100V	0.4typ (Io=100%) Universal Input								
		ACIN 200V	0.2typ (Io=100%) Universal Input								
	FREQUENCY[Hz]	47 - 440 or DC									
	EFFICIENCY[%]	ACIN 100V	65typ (Io=100%)								
	INRUSH CURRENT[A]	ACIN 100V	20typ (Io=100%) (At cold start)								
OUTPUT	VOLTAGE[V]	+5	+12	-12	+5	+15	-15	+5	+12	-5	
	CURRENT[A]	2.0	0.3	0.2	2.0	0.3	0.2	2.0	0.3	0.2	
	MINIMUM CURRENT[A]	0.1	0	0	0.1	0	0	0.1	0	0	
	LINE REGULATION[mV]	20max	48max	48max	20max	60max	60max	20max	48max	20max	
	LOAD REGULATION[mV]	100max	120max	120max	100max	150max	150max	100max	120max	50max	
	RIPPLE[mVp-p]	100max	60max	60max	100max	60max	60max	100max	60max	60max	
	RIPPLE NOISE[mVp-p]	120max	150max	150max	120max	150max	150max	120max	150max	150max	
	TEMPERATURE REGULATION[mV]	0 to +50°C	50max	350max	350max	50max	350max	350max	50max	350max	350max
	START-UP TIME[ms]	100max (ACIN 85V, Io=100%)									
	HOLD-UP TIME[ms]	10typ (ACIN 85V, Io=100%)									
PROTECTION CIRCUIT	OVERCURRENT PROTECTION	Works over 105% of rating and recovers automatically									
	INPUT-OUTPUT	AC3.000V 1minute, Cutoff current = 10mA, DC500V 50MΩmin (At Room Temperature)									
ISOLATION	INPUT-CASE	AC2.000V 1minute, Cutoff current = 10mA, DC500V 50MΩmin (At Room Temperature)									
	OUTPUT-CASE	AC500V 1minute, Cutoff current = 100mA, DC500V 50MΩmin (At Room Temperature)									
	OUTPUT-OUTPUT(V1-V2,V3)	AC100V 1minute, Cutoff current = 100mA, DC100V 10MΩmin (At Room Temperature)									
ENVIRONMENT	OPERATING TEMP.,HUMID.AND ALTITUDE	0 to +65°C, 20 - 90%RH (Non condensing) (Refer to DERATING CURVE), 3,000m (10,000feet) max									
	STORAGE TEMP.,HUMID.AND ALTITUDE	-20 to +75°C, 20 - 90%RH (Non condensing), 9,000m (30,000feet) max									
	VIBRATION	10 - 55Hz, 19.6m/s ² (2G), 3minutes period, 30minutes each along X, Y and Z axis									
	IMPACT	196.1m/s ² (20G), 11ms, once each X, Y and Z axis									
SAFETY AND NOISE REGULATIONS	AGENCY APPROVALS	UL60950-1, CSA C22.2 No.60950-1, EN60950-1, EN50178 Complies with IEC60950-1 and DEN-AN									
	CONDUCTED NOISE	Complies with FCC-B									

*1 Please contact us about safety approvals for the model with option.
* Series/Parallel operation with other model is not possible.

External view

(PIN CONNECTION)

CN1	PIN NO.	INPUT
	1	FG
2	AC (L)	
3	NC	
4	AC (N)	

CN2	PIN NO.	OUTPUT
	1	NC
2	G1	
3	V1	
4	V3	
5	G2	
6	V2	

※V1 is isolated from V2 and V3.

I/O Connector	Mating Connector	Terminal
CN1	10-31-1048	10-63-3044
CN2	10-31-1068	10-63-3064

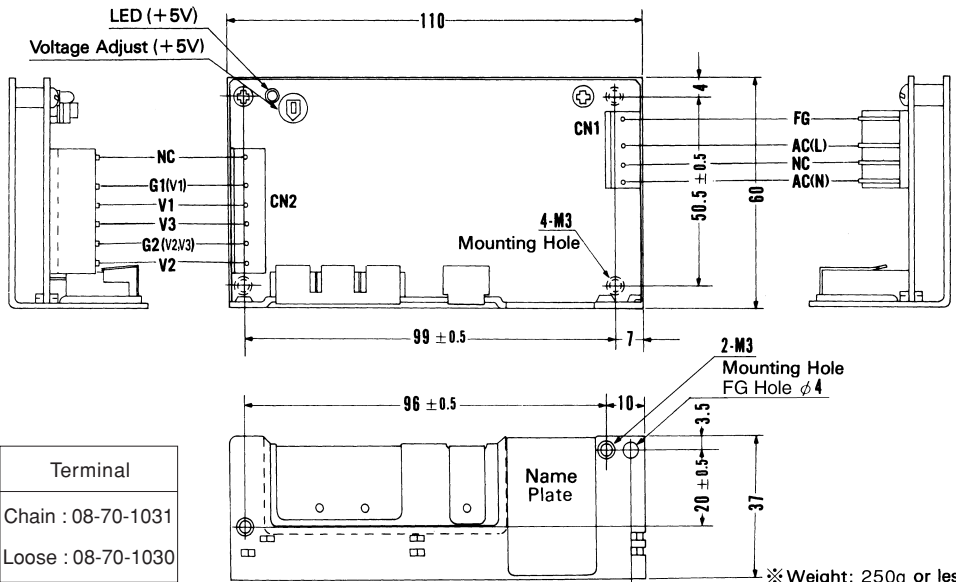

※ Weight: 250g or less.
 ※ Tolerance: ±1
 ※ Dimensions in mm.
 ※ Mounting torque : 0.49N·m (5.0 kgf·cm) max

Performance data

■ STATIC CHARACTERISTICS (PMC15E-1)

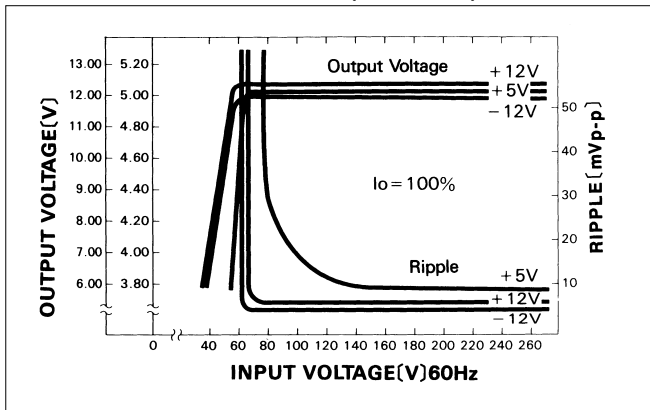

■ RISE TIME & FALL TIME (PMC15E-1)

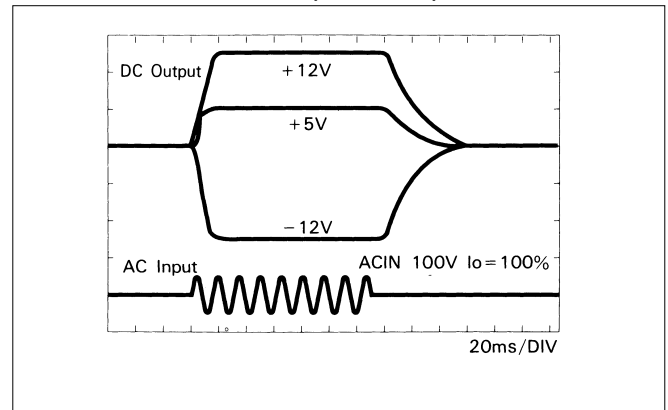

■ OVERCURRENT CHARACTERISTICS (PMC15E-1)

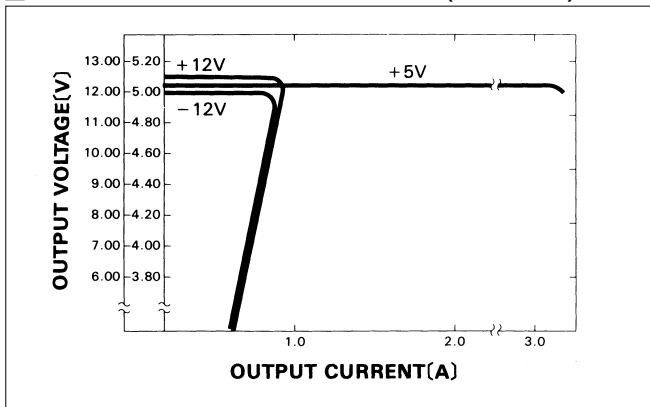

■ DERATING CURVE

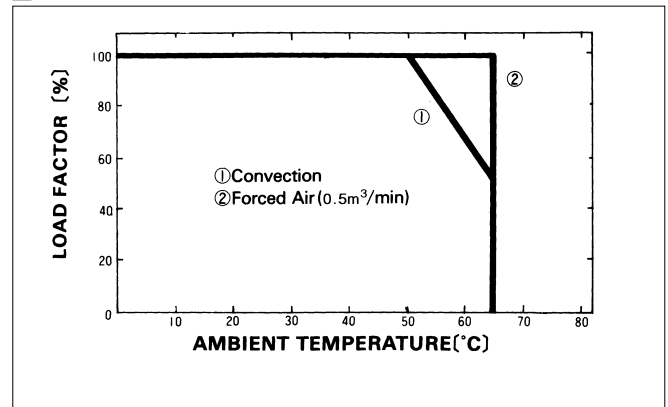

PMC30

PMC 30 E -1 -□

① ② ③ ④ ⑤

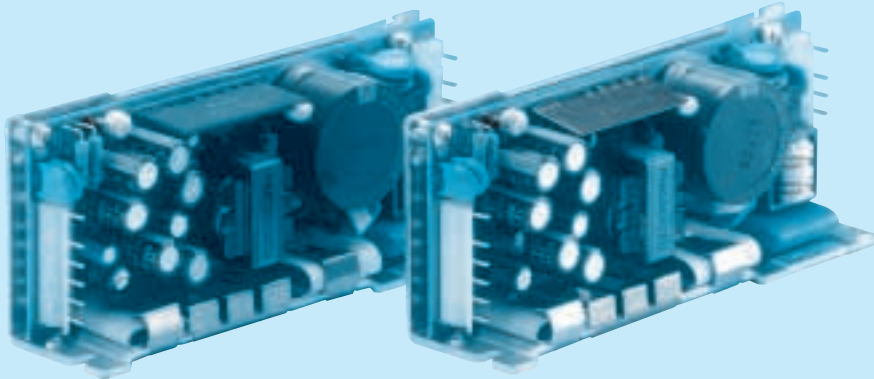

- ① Series name
- ② Output wattage
- ③ UL recognized, TÜV approved, CSA certified : E
- ④ Output voltage combination
- ⑤ Optional *1
C :with Coating
G :Low leakage current

PMC

MODEL	PMC30E-1	PMC30E-2
DC OUTPUT	V1	+5V 3.0A
	V2	+12V 1.2A
	V3	-12V 0.3A

SPECIFICATIONS

	MODEL	PMC30E-1	PMC30E-2				
INPUT	VOLTAGE[V]	AC85 - 264 1 φ or DC110 - 370					
	CURRENT[A]	ACIN 100V	0.8typ (Io=100%) Universal Input				
		ACIN 200V	0.4typ (Io=100%) Universal Input				
	FREQUENCY[Hz]	47 - 440 or DC					
	EFFICIENCY[%]	ACIN 100V	65typ (Io=100%)				
	INRUSH CURRENT[A]	ACIN 100V	25typ (Io=100%) (At cold start)				
OUTPUT	VOLTAGE[V]	+5	+12	-12	+5	+15	-15
	CURRENT[A]	3.0	1.2	0.3	3.0	0.7	0.5
	MINIMUM CURRENT[A]	0.3	0	0	0.3	0	0
	LINE REGULATION[mV]	20max	48max	48max	20max	60max	60max
	LOAD REGULATION[mV]	100max	120max	150max	100max	120max	150max
	RIPPLE[mVp-p]	100max	120max	60max	100max	120max	100max
	RIPPLE NOISE[mVp-p]	120max	150max	150max	120max	150max	150max
	TEMPERATURE REGULATION[mV]	0 to +50°C	50max	350max	350max	50max	350max
	START-UP TIME[ms]	100max (ACIN 85V, Io=100%)					
	HOLD-UP TIME[ms]	10typ (ACIN 85V, Io=100%)					
OUTPUT VOLTAGE ADJUSTMENT RANGE[V]	5.00 - 5.25	Fixed	Fixed	5.00 - 5.25	Fixed	Fixed	
OUTPUT VOLTAGE SETTING[V]	—	11.4 to 12.6	-11.4 to -12.6	—	14.25 to 15.75	-14.25 to -15.75	
PROTECTION CIRCUIT	OVERCURRENT PROTECTION	Works over 105% of rating and recovers automatically					
ISOLATION	INPUT-OUTPUT	AC3,000V 1minute, Cutoff current = 10mA, DC500V 50MΩmin (At Room Temperature)					
	INPUT-CASE	AC2,000V 1minute, Cutoff current = 10mA, DC500V 50MΩmin (At Room Temperature)					
	OUTPUT-CASE	AC500V 1minute, Cutoff current = 100mA, DC500V 50MΩmin (At Room Temperature)					
	OUTPUT-OUTPUT(V1-V2,V3)	AC100V 1minute, Cutoff current = 100mA, DC100V 10MΩmin (At Room Temperature)					
ENVIRONMENT	OPERATING TEMP.,HUMID.AND ALTITUDE	0 to +65°C, 20 - 90%RH (Non condensing) (Refer to DERATING CURVE), 3,000m (10,000feet) max					
	STORAGE TEMP.,HUMID.AND ALTITUDE	-20 to +75°C, 20 - 90%RH (Non condensing), 9,000m (30,000feet) max					
	VIBRATION	10 - 55Hz, 19.6m/s ² (2G), 3minutes period, 30minutes each along X, Y and Z axis					
	IMPACT	196.1m/s ² (20G), 11ms, once each X, Y and Z axis					
SAFETY AND NOISE REGULATIONS	AGENCY APPROVALS	UL60950-1, CSA1402C, EN60950-1, EN50178 Complies with IEC60950-1 and DEN-AN					
	CONDUCTED NOISE	Complies with FCC-B					

*1 Please contact us about safety approvals for the model with option.
* Series/Parallel operation with other model is not possible.

External view

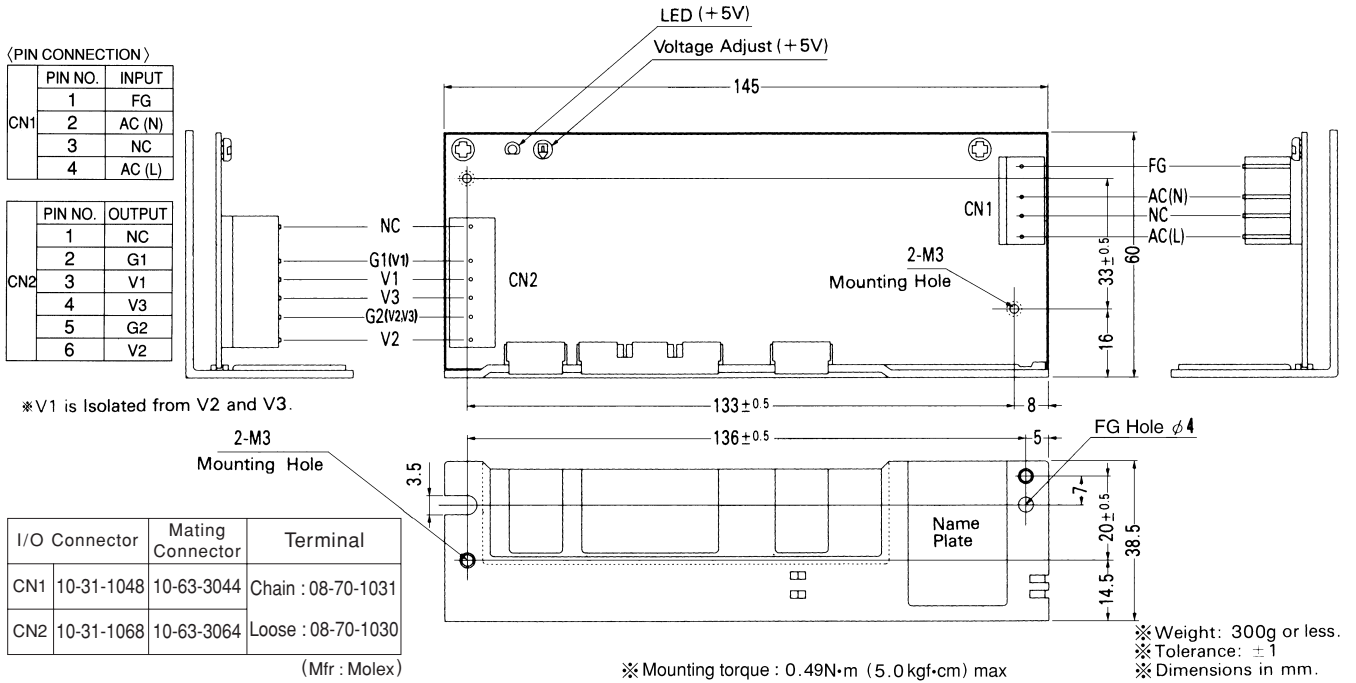

PMC

Performance data

■ STATIC CHARACTERISTICS (PMC30E-1)

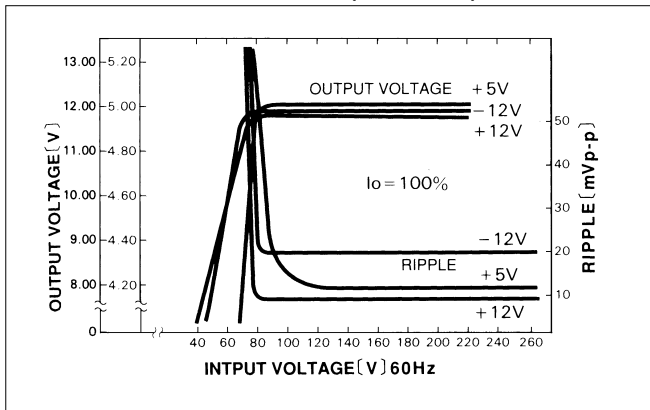

■ RISE TIME & FALL TIME (PMC30E-1)

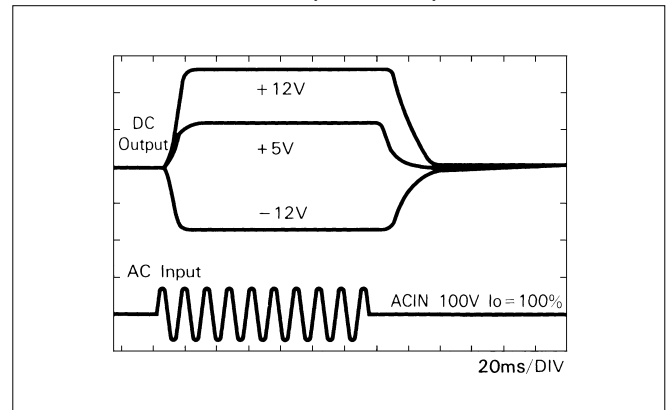

■ OVERCURRENT CHARACTERISTICS (PMC30E-1)

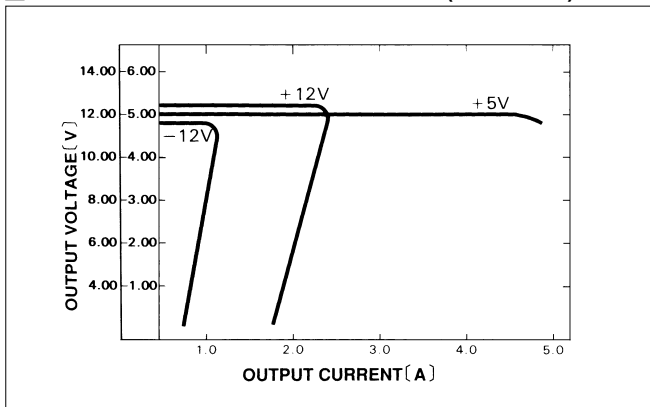

■ DERATING CURVE

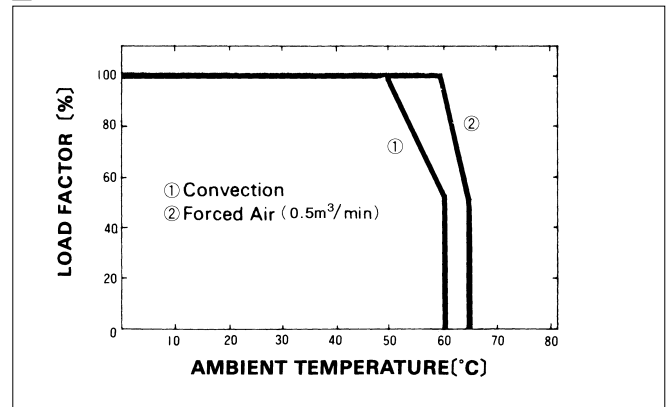

PMC50

PMC 50 E -1 -XULA -□

① ② ③ ④ ⑤

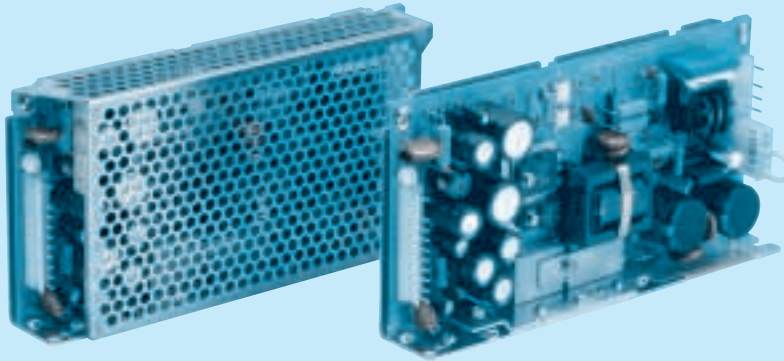

- ① Series name
- ② Output wattage
- ③ UL recognized, TÜV approved, CSA certified : E
- ④ Output voltage combination
- ⑤ Optional *1
C :with Coating
N :with Cover

PMC

MODEL		PMC50E-1-XULA	PMC50E-2-XULA	PMC50E-4-XULA
DC OUTPUT	V1	+5V 5.0A	+5V 5.0A	+5V 7.0A
	V2	+12V 1.25(Peak 2.0)A	+15V 1.0A	+12V 0.7(Peak 1.5)A
	V3	-12V 0.35A	-15V 0.35A	-12V 0.2A

SPECIFICATIONS

	MODEL	PMC50E-1-XULA			PMC50E-2-XULA			PMC50E-4-XULA			
INPUT	VOLTAGE[V]	AC85 - 132 / 170 - 264 1φ (User-selectable) or DC220 - 370									
	CURRENT[A]	ACIN 100V	1.4typ (Io=100%) User-selectable								
		ACIN 200V	0.7typ (Io=100%) User-selectable								
	FREQUENCY[Hz]	47 - 440									
	EFFICIENCY[%]	ACIN 100V	70typ (Io=100%)								
INRUSH CURRENT[A]	ACIN 100V	20typ (Io=100%) (At cold start)									
	ACIN 200V	40typ (Io=100%) (At cold start)									
OUTPUT	VOLTAGE[V]	+5	+12	-12	+5	+15	-15	+5	+12	-12	
	CURRENT[A]	0.75 - 5	0-1.25(Peak2.0)	0 - 0.35	0.75 - 5	0 - 1.0	0 - 0.35	0.75 - 7	0-0.7(Peak1.5)	0 - 0.2	
	MINIMUM CURRENT[A]	0.75	0	0	0.75	0	0	0.75	0	0	
	LINE REGULATION[mV]	20max	48max	48max	20max	60max	60max	20max	48max	48max	
	LOAD REGULATION[mV]	40max	150max	150max	40max	150max	150max	40max	150max	150max	
	RIPPLE[mVp-p]	80max	120max	120max	80max	120max	120max	80max	120max	120max	
	RIPPLE NOISE[mVp-p]	120max	150max	150max	120max	150max	150max	120max	150max	150max	
	TEMPERATURE REGULATION[mV]	0 to +50°C	50max	350max	350max	50max	350max	350max	50max	350max	350max
	START-UP TIME[ms]	100max (ACIN 85V, Io=100%)									
	HOLD-UP TIME[ms]	10typ (ACIN 85V, Io=100%) 20typ (ACIN 100V, Io=100%)									
PROTECTION CIRCUIT	OVERCURRENT PROTECTION	Works at over 105% of rating (V2 works at peak current)and recovers automatically									
	OVERVOLTAGE PROTECTION	Works at 115 - 140% of rating (+5V)									
ISOLATION	INPUT-OUTPUT	AC3,000V 1minute, Cutoff current = 10mA, DC500V 50MΩmin (At Room Temperature)									
	INPUT-FG	AC2,000V 1minute, Cutoff current = 10mA, DC500V 50MΩmin (At Room Temperature)									
	OUTPUT-FG	AC500V 1minute, Cutoff current = 100mA, DC500V 50MΩmin (At Room Temperature)									
	OUTPUT-OUTPUT(V1-V2,V3)	AC100V 1minute, Cutoff current = 100mA, DC100V 10MΩmin (At Room Temperature)									
ENVIRONMENT	OPERATING TEMP.,HUMID.AND ALTITUDE	-10 to +65°C, 20 - 95%RH (Non condensing) (Refer to DERATING CURVE), 3,000m (10,000feet) max									
	STORAGE TEMP.,HUMID.AND ALTITUDE	-25 to +75°C, 20 - 95%RH (Non condensing), 9,000m (30,000feet) max									
	VIBRATION	10 - 55Hz, 19.6m/s ² (2G), 3minutes period, 30minutes each along X, Y and Z axis									
	IMPACT	196.1m/s ² (20G), 11ms, once each X, Y and Z axis									
SAFETY AND NOISE REGULATIONS	AGENCY APPROVALS	UL60950-1, CSA C22.2 No.60950-1, EN60950-1, EN50178 Complies with IEC60950-1 and DEN-AN									
	CONDUCTED NOISE	Complies with FCC-B									

*1 Please contact us about safety approvals for the model with option.
* Series/Parallel operation with other model is not possible.
* When units are operated with chassis and cover, derating is required.

External view

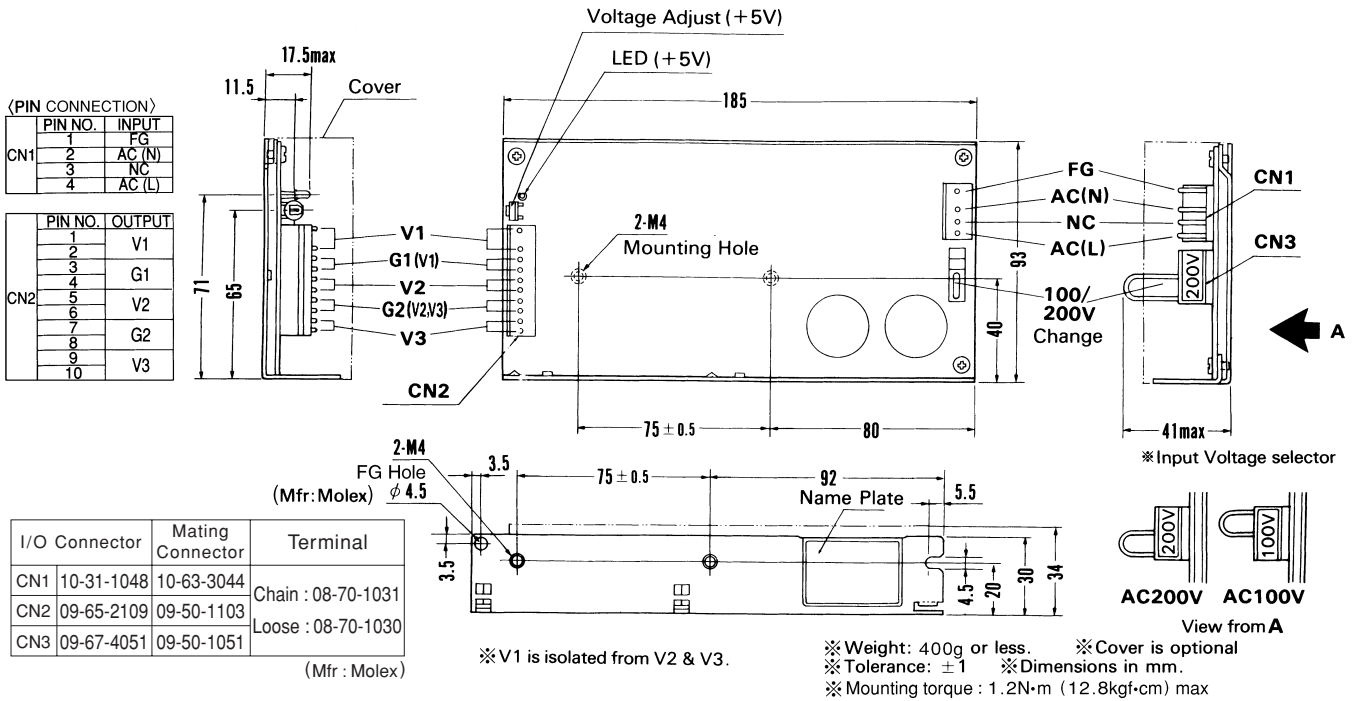

Performance data

■ STATIC CHARACTERISTICS (PMC50E-1-XULA)

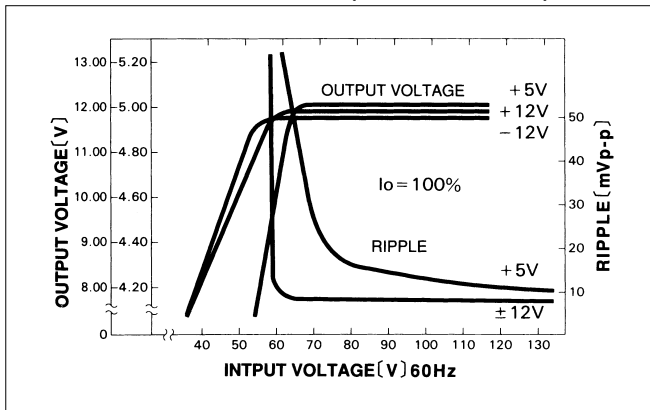

■ RISE TIME & FALL TIME (PMC50E-1-XULA)

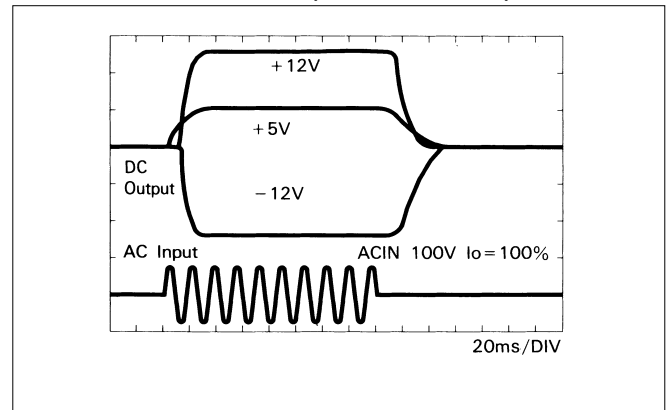

■ OVERCURRENT CHARACTERISTICS (PMC50E-1-XULA)

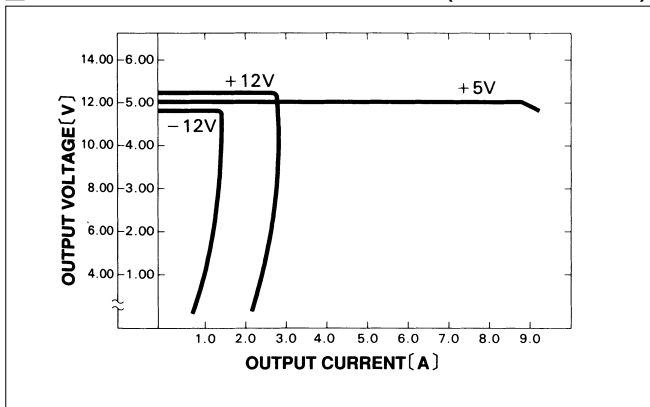

■ DERATING CURVE

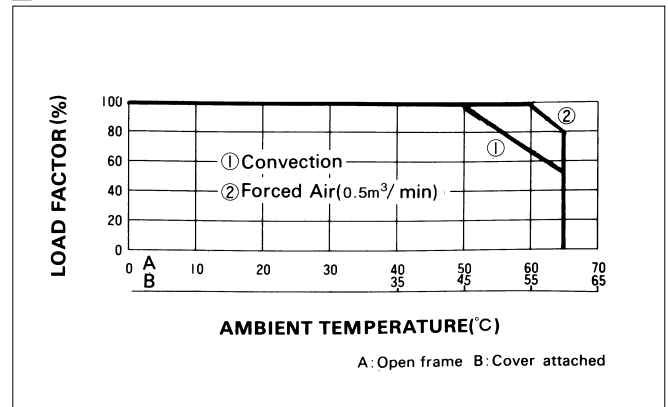

PMC75

PMC 75 E -1 -□

① ② ③ ④ ⑤



RoHS

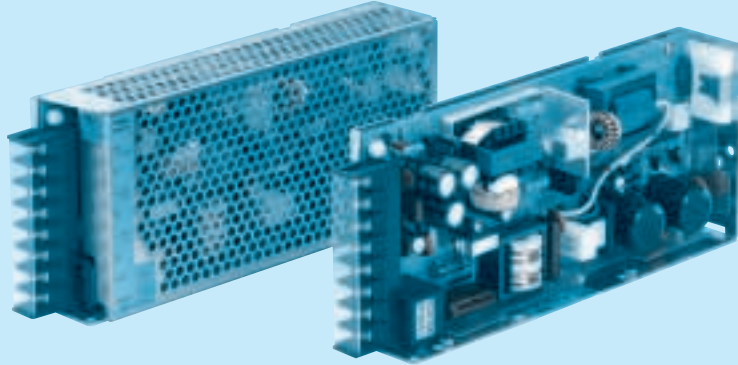

- ① Series name
- ② Output wattage
- ③ UL recognized, TÜV approved, CSA certified
: E
- ④ Output voltage combination
- ⑤ Optional *1
C :with Coating
G :Low leakage current
J :Connector type
N :with Cover

PMC

MODEL		PMC75E-1	PMC75E-2	PMC75E-4
DC OUTPUT	V1	+5V 8.0A	+5V 8.0A	+5V 6.0A
	V2	+12V 2.5A	+15V 1.8A	+12V 3.2A
	V3	-12V 0.5A	-15V 0.5A	-12V 0.5A

SPECIFICATIONS

	MODEL	PMC75E-1			PMC75E-2			PMC75E-4			
INPUT	VOLTAGE[V]	AC85 - 132 / 170 - 264 1φ (User-selectable) or DC220 - 370									
	CURRENT[A]	ACIN 100V	1.8typ (Io=100%) User-selectable								
		ACIN 200V	1.0typ (Io=100%) User-selectable								
	FREQUENCY[Hz]	47 - 440									
	EFFICIENCY[%]	ACIN 100V	75typ (Io=100%)								
	INRUSH CURRENT[A]	ACIN 100V	15typ (Io=100%)								
ACIN 200V		30typ (Io=100%)									
OUTPUT	VOLTAGE[V]	+5	+12	-12	+5	+15	-15	+5	+12	-12	
	CURRENT[A]	8	2.5	0.5	8	1.8	0.5	6	3.2	0.5	
	MINIMUM CURRENT[A]	1.5	0	0	1.5	0	0	1.5	0	0	
	LINE REGULATION[mV]	20max	48max	48max	20max	60max	60max	20max	48max	48max	
	LOAD REGULATION[mV]	40max	100max	150max	40max	120max	150max	40max	100max	150max	
	RIPPLE[mVp-p]	80max	120max	120max	80max	120max	120max	80max	120max	120max	
	RIPPLE NOISE[mVp-p]	120max	150max	150max	120max	150max	150max	120max	150max	150max	
	TEMPERATURE REGULATION[mV]	0 to +50°C	50max	120max	350max	50max	150max	350max	50max	120max	350max
	START-UP TIME[ms]	200max (ACIN 85V, Io=100%)									
	HOLD-UP TIME[ms]	10typ (ACIN 85V, Io=100%) 20typ (ACIN 100V, Io=100%)									
	OUTPUT VOLTAGE ADJUSTMENT RANGE[V]	5.00 - 5.25	Fixed	Fixed	5.00 - 5.25	Fixed	Fixed	5.00 - 5.25	Fixed	Fixed	
OUTPUT VOLTAGE SETTING[V]	—	11.4 to 12.6	-11.4 to -12.6	—	14.25 to 15.75	-14.25 to -15.75	—	11.4 to 12.6	-11.4 to -12.6		
PROTECTION CIRCUIT	OVERCURRENT PROTECTION	Works over 105% of rating and recovers automatically									
	OVERVOLTAGE PROTECTION	Works at 115 - 140% of rating (+5V)									
ISOLATION	INPUT-OUTPUT	AC3,000V 1minute, Cutoff current = 10mA, DC500V 50MΩmin (At Room Temperature)									
	INPUT-FG	AC2,000V 1minute, Cutoff current = 10mA, DC500V 50MΩmin (At Room Temperature)									
	OUTPUT-FG	AC500V 1minute, Cutoff current = 100mA, DC500V 50MΩmin (At Room Temperature)									
	OUTPUT-OUTPUT(V1-V2,V3)	AC100V 1minute, Cutoff current = 100mA, DC100V 10MΩmin (At Room Temperature)									
ENVIRONMENT	OPERATING TEMP.,HUMID.AND ALTITUDE	-10 to +65°C, 20 - 95%RH (Non condensing) (Refer to DERATING CURVE), 3,000m (10,000feet) max									
	STORAGE TEMP.,HUMID.AND ALTITUDE	-25 to +75°C, 20 - 95%RH (Non condensing), 9,000m (30,000feet) max									
	VIBRATION	10 - 55Hz, 19.6m/s ² (2G), 3minutes period, 30minutes each along X, Y and Z axis									
	IMPACT	196.1m/s ² (20G), 11ms, once each X, Y and Z axis									
SAFETY AND NOISE REGULATIONS	AGENCY APPROVALS	UL60950-1, CSA C22.2 No.60950-1, EN60950-1, EN50178 Complies with IEC60950-1 and DEN-AN									
	CONDUCTED NOISE	Complies with FCC-B									

*1 Please contact us about safety approvals for the model with option.
* Series/Parallel operation with other model is not possible.
* When units are operated with chassis and cover, derating is required.

External view

(PIN CONNECTION)

PIN NO.	INPUT
1	FG
2	AC(L)
3	NC
4	AC(N)

PIN NO.	OUTPUT
1	V1
2	G1
3	V2
4	G2
5	V3
6	
7	
8	
9	
10	

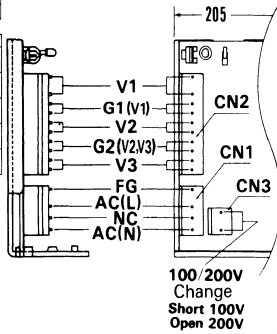

I/O Connector	Mating Connector	Terminal
CN1	10-31-1048	10-63-3044
CN2	09-65-2109	09-50-1103
CN3	10-31-1028	10-63-3024

Chain : 08-70-1031
Loose : 08-70-1030

(Mfr : Molex)

Connector type

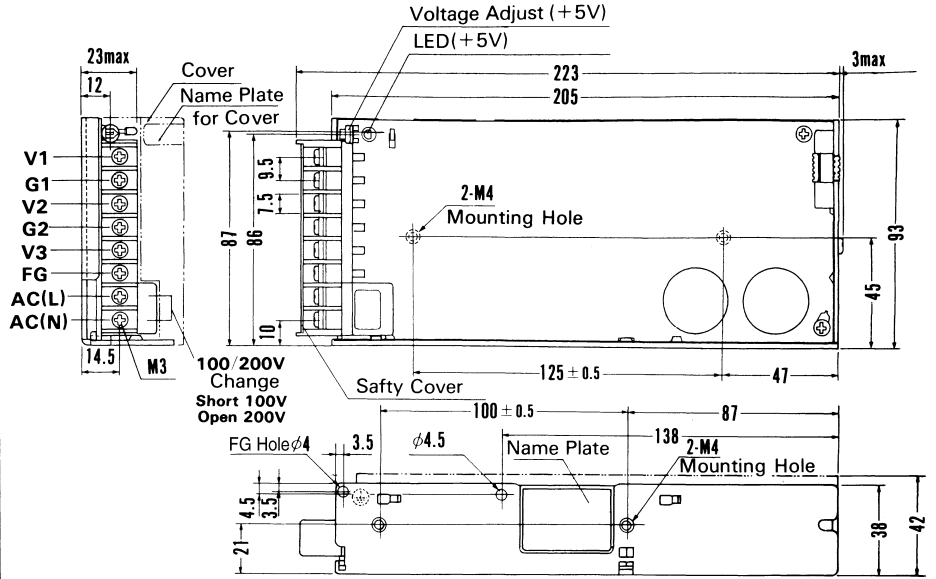

※V1 is isolated from V2 & V3.

※ Weight: 600g or less. ※ Cover is optional
 ※ Tolerance: ±1 ※ Dimensions in mm
 ※ Mounting torque : 1.2N·m (12.8kgf·cm) max

Barrier strip type

Performance data

■ STATIC CHARACTERISTICS (PMC75E-1)

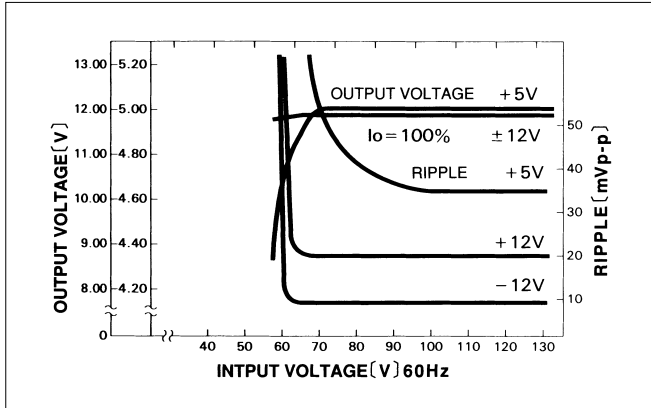

■ RISE TIME & FALL TIME (PMC75E-1)

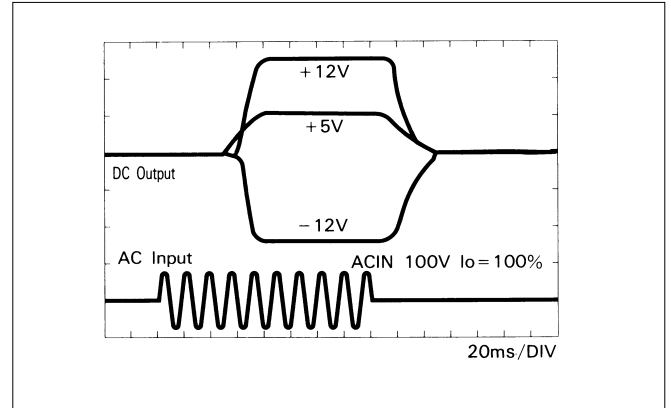

■ OVERCURRENT CHARACTERISTICS (PMC75E-1)

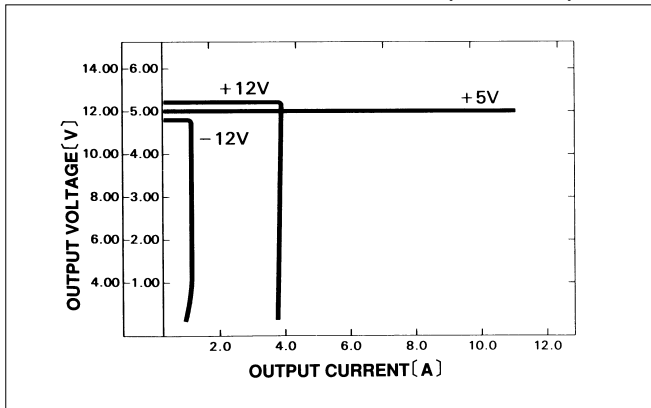

■ DERATING CURVE

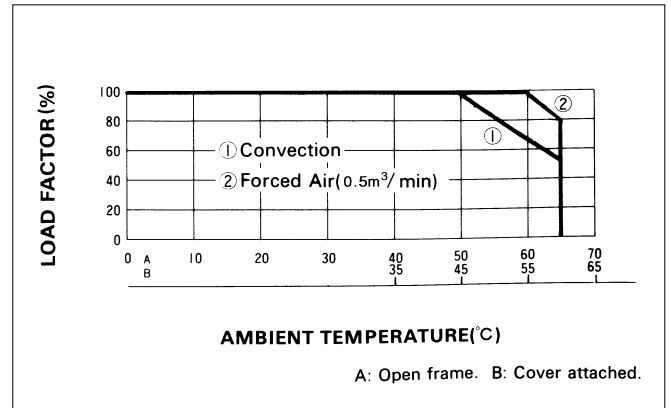

PMC100

PMC 100 E -1 -□

① ② ③ ④ ⑤

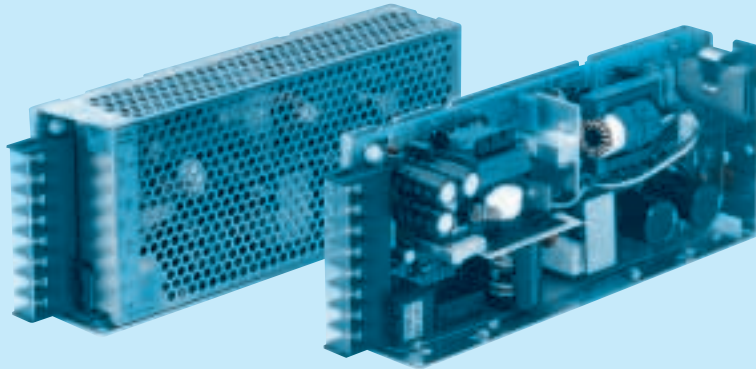

- ① Series name
- ② Output wattage
- ③ UL recognized, TÜV approved, CSA certified : E
- ④ Output voltage combination
- ⑤ Optional *1
G : Low leakage current
J : Connector type
N : with Cover

PMC

MODEL		PMC100E-1	PMC100E-2	PMC100E-4
DC OUTPUT	V1	+5V 13.0A	+5V 13.0A	+5V 8.0A
	V2	+12V 2.0A	+15V 1.5A	+12V 4.0A
	V3	-12V 1.0A	-15V 1.0A	-12V 1.0A

SPECIFICATIONS

	MODEL	PMC100E-1			PMC100E-2			PMC100E-4			
INPUT	VOLTAGE[V]	AC85 - 132 / 170 - 264 1φ (User-selectable) or DC220 - 370									
	CURRENT[A]	ACIN 100V	2.4typ (Io=100%) User-selectable								
		ACIN 200V	1.4typ (Io=100%) User-selectable								
	FREQUENCY[Hz]	47 - 440									
	EFFICIENCY[%]	ACIN 100V	75typ (Io=100%)								
	INRUSH CURRENT[A]	ACIN 100V	15typ (Io=100%)								
ACIN 200V		30typ (Io=100%)									
OUTPUT	VOLTAGE[V]	+5	+12	-12	+5	+15	-15	+5	+12	-12	
	CURRENT[A]	13	2	1	13	1.5	1	8	4	1	
	MINIMUM CURRENT[A]	1.5	0	0	1.5	0	0	1.5	0	0	
	LINE REGULATION[mV]	20max	48max	48max	20max	60max	60max	20max	48max	48max	
	LOAD REGULATION[mV]	40max	100max	150max	40max	120max	150max	40max	100max	150max	
	RIPPLE[mVp-p]	80max	120max	120max	80max	120max	120max	80max	120max	120max	
	RIPPLE NOISE[mVp-p]	120max	150max	150max	120max	150max	150max	120max	150max	150max	
	TEMPERATURE REGULATION[mV]	0 to +50°C	50max	120max	350max	50max	150max	350max	50max	120max	350max
	START-UP TIME[ms]	200max (ACIN 85V, Io=100%)									
	HOLD-UP TIME[ms]	10typ (ACIN 85V, Io=100%) 20typ (ACIN 100V, Io=100%)									
	OUTPUT VOLTAGE ADJUSTMENT RANGE[V]	5.00 - 5.25	Fixed	Fixed	5.00 - 5.25	Fixed	Fixed	5.00 - 5.25	Fixed	Fixed	
OUTPUT VOLTAGE SETTING[V]	—	11.4 to 12.6	-11.4 to -12.6	—	14.25 to 15.75	-14.25 to -15.75	—	11.4 to 12.6	-11.4 to -12.6		
PROTECTION CIRCUIT	OVERCURRENT PROTECTION	Works over 105% of rating and recovers automatically									
	OVERVOLTAGE PROTECTION	Works at 115 - 140% of rating (+5V)									
ISOLATION	INPUT-OUTPUT	AC3,000V 1minute, Cutoff current = 10mA, DC500V 50MΩmin (At Room Temperature)									
	INPUT-FG	AC2,000V 1minute, Cutoff current = 10mA, DC500V 50MΩmin (At Room Temperature)									
	OUTPUT-FG	AC500V 1minute, Cutoff current = 100mA, DC500V 50MΩmin (At Room Temperature)									
	OUTPUT-OUTPUT(V1-V2,V3)	AC100V 1minute, Cutoff current = 100mA, DC100V 10MΩmin (At Room Temperature)									
ENVIRONMENT	OPERATING TEMP., HUMID. AND ALTITUDE	-10 to +65°C, 20 - 95%RH (Non condensing) (Refer to DERATING CURVE), 3,000m (10,000feet)									
	STORAGE TEMP., HUMID. AND ALTITUDE	-25 to +75°C, 20 - 95%RH (Non condensing) 9,000m (30,000feet) max									
	VIBRATION	10 - 55Hz, 19.6m/s ² (2G), 3minutes period, 30minutes each along X, Y and Z axis									
	IMPACT	196.1m/s ² (20G), 11ms, once each X, Y and Z axis									
SAFETY AND NOISE REGULATIONS	AGENCY APPROVALS	UL60950-1, CSA1402C, EN60950-1, EN50178 Complies with IEC60950-1 and DEN-AN									
	CONDUCTED NOISE	Complies with FCC-B									

*1 Please contact us about safety approvals for the model with option.
* Series/Parallel operation with other model is not possible.
* When units are operated with chassis and cover, derating is required.

External view

(PIN CONNECTION)

PIN NO.	INPUT
1	FG
2	AC(L)
3	NC
4	AC(N)

PIN NO.	OUTPUT
1	V1
2	G1
3	V2
4	G2
5	V3
6	G2
7	G1
8	V3
9	V1
10	V3

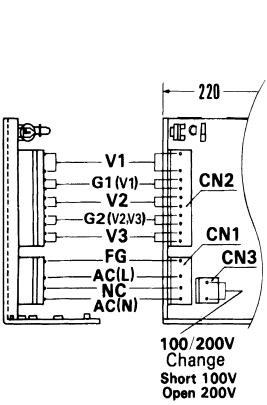

100/200V Change
Short 100V
Open 200V

I/O Connector	Mating Connector	Terminal
CN1	10-31-1048	10-63-3044
CN2	09-65-2109	09-50-1103
CN3	10-31-1028	10-63-3024

(Mfr: Molex)

Connector type

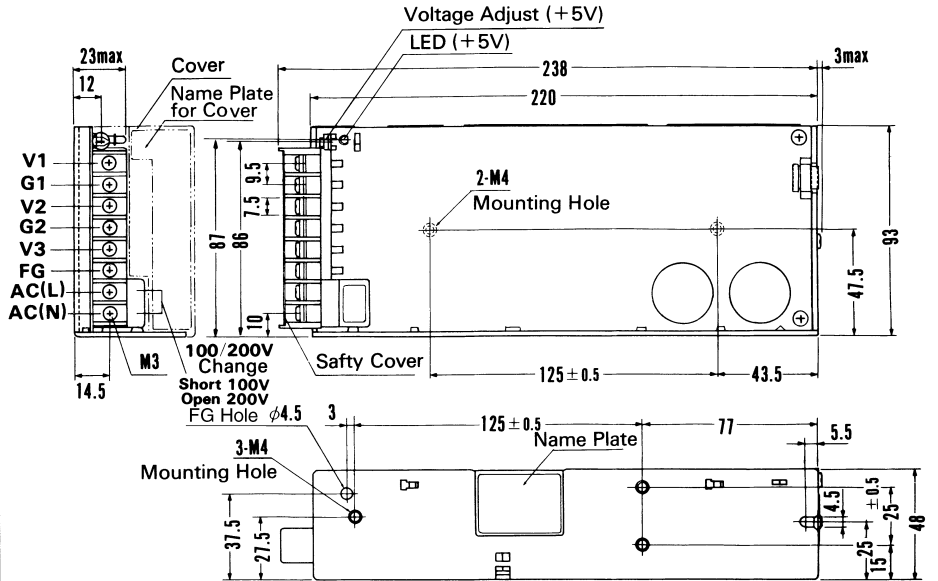

※ V1 is isolated from V2 & V3.

※ Weight: 750g or less. ※ Cover is optional
 ※ Tolerance: ±1 ※ Dimensions in mm.
 ※ Mounting torque: 1.2N·m (12.8kgf·cm) max

Barrier strip type

Performance data

■ STATIC CHARACTERISTICS (PMC100E-1)

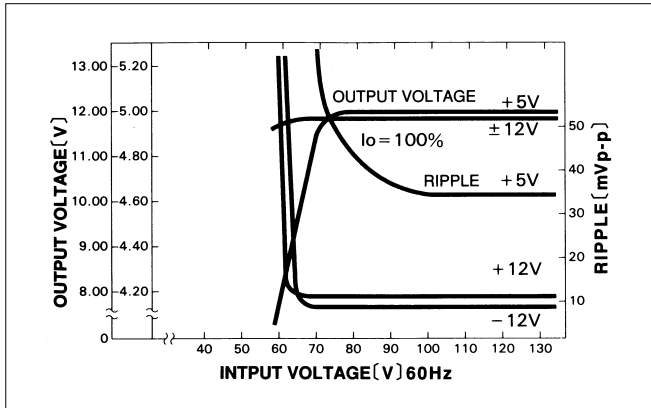

■ RISE TIME & FALL TIME (PMC100E-1)

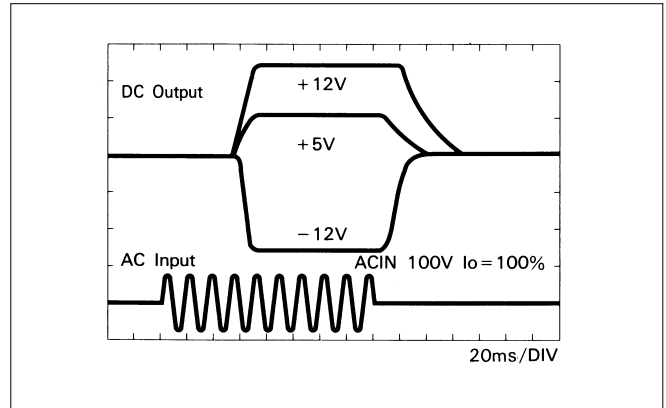

■ OVERCURRENT CHARACTERISTICS (PMC100E-1)

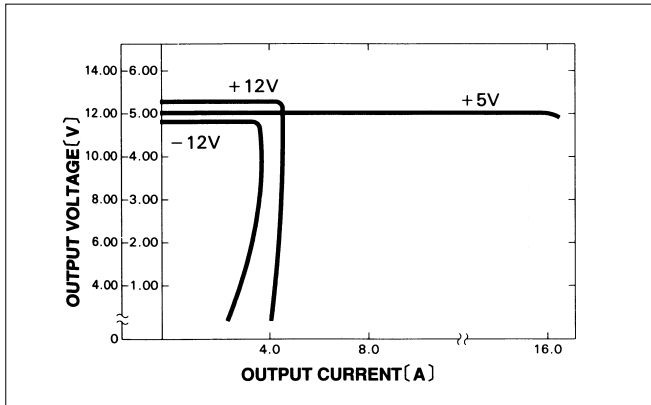

■ DERATING CURVE

