



Chipsmall Limited consists of a professional team with an average of over 10 year of expertise in the distribution of electronic components. Based in Hongkong, we have already established firm and mutual-benefit business relationships with customers from,Europe,America and south Asia,supplying obsolete and hard-to-find components to meet their specific needs.

With the principle of “Quality Parts,Customers Priority,Honest Operation,and Considerate Service”,our business mainly focus on the distribution of electronic components. Line cards we deal with include Microchip,ALPS,ROHM,Xilinx,Pulse,ON,Everlight and Freescale. Main products comprise IC,Modules,Potentiometer,IC Socket,Relay,Connector.Our parts cover such applications as commercial,industrial, and automotives areas.

We are looking forward to setting up business relationship with you and hope to provide you with the best service and solution. Let us make a better world for our industry!



Contact us

Tel: +86-755-8981 8866 Fax: +86-755-8427 6832

Email & Skype: info@chipsmall.com Web: www.chipsmall.com

Address: A1208, Overseas Decoration Building, #122 Zhenhua RD., Futian, Shenzhen, China



Important notice

Dear Customer,

On 7 February 2017 the former NXP Standard Product business became a new company with the tradename **Nexperia**. Nexperia is an industry leading supplier of Discrete, Logic and PowerMOS semiconductors with its focus on the automotive, industrial, computing, consumer and wearable application markets

In data sheets and application notes which still contain NXP or Philips Semiconductors references, use the references to Nexperia, as shown below.

Instead of <http://www.nxp.com>, <http://www.philips.com/> or <http://www.semiconductors.philips.com/>, use <http://www.nexperia.com>

Instead of sales.addresses@www.nxp.com or sales.addresses@www.semiconductors.philips.com, use salesaddresses@nexperia.com (email)

Replace the copyright notice at the bottom of each page or elsewhere in the document, depending on the version, as shown below:

- © NXP N.V. (year). All rights reserved or © Koninklijke Philips Electronics N.V. (year). All rights reserved

Should be replaced with:

- © **Nexperia B.V. (year). All rights reserved.**

If you have any questions related to the data sheet, please contact our nearest sales office via e-mail or telephone (details via salesaddresses@nexperia.com). Thank you for your cooperation and understanding,

Kind regards,

Team Nexperia

PMEGxx05EH/EJ series

0.5 A very low V_F MEGA Schottky barrier rectifiers

Rev. 02 — 13 January 2010

Product data sheet

1. Product profile

1.1 General description

Planar Maximum Efficiency General Application (MEGA) Schottky barrier rectifier with an integrated guard ring for stress protection encapsulated in small SMD package.

Table 1. Product overview

Type number	Package		Configuration
	NXP	JEITA	
PMEG2005EH	SOD123F	-	single diode
PMEG3005EH			
PMEG4005EH			
PMEG2005EJ	SOD323F	SC-90	single diode
PMEG3005EJ			
PMEG4005EJ			

1.2 Features

- Forward current: 0.5 A
- Very low forward voltage
- Flat lead SMD package

1.3 Applications

- Low voltage rectification
- High efficiency DC-to-DC conversion
- Switch mode power supply
- Inverse polarity protection
- Low power consumption applications

1.4 Quick reference data



Table 2. Quick reference data

Symbol	Parameter	Conditions	Min	Typ	Max	Unit
I_F	forward current	$T_{sp} \leq 55\text{ °C}$	-	-	0.5	A
V_R	reverse voltage					
	PMEG2005EH, PMEG2005EJ		-	-	20	V
	PMEG3005EH, PMEG3005EJ		-	-	30	V
	PMEG4005EH, PMEG4005EJ		-	-	40	V
V_F	forward voltage	$I_F = 500\text{ mA}$	[1]			
	PMEG2005EH, PMEG2005EJ		-	355	390	mV
	PMEG3005EH, PMEG3005EJ		-	380	430	mV
	PMEG4005EH, PMEG4005EJ		-	420	470	mV

[1] Pulse test: $t_p \leq 300\text{ }\mu\text{s}$; $\delta \leq 0.02$.

2. Pinning information

Table 3. Pinning

Pin	Description	Simplified outline	Symbol
1	cathode	[1]	  <i>sym001</i>
2	anode		

[1] The marking bar indicates the cathode.

3. Ordering information

Table 4. Ordering information

Type number	Package		Version
	Name	Description	
PMEG2005EH	-	plastic surface mounted package; 2 leads	SOD123F
PMEG3005EH			
PMEG4005EH			
PMEG2005EJ	SC-90	plastic surface mounted package; 2 leads	SOD323F
PMEG3005EJ			
PMEG4005EJ			

4. Marking

Table 5. Marking codes

Type number	Marking code
PMEG2005EH	A3
PMEG3005EH	A4
PMEG4005EH	A5
PMEG2005EJ	CC
PMEG3005EJ	CD
PMEG4005EJ	CE

5. Limiting values

Table 6. Limiting values

In accordance with the Absolute Maximum Rating System (IEC 60134).

Symbol	Parameter	Conditions	Min	Max	Unit	
V_R	reverse voltage					
	PMEG2005EH, PMEG2005EJ		-	20	V	
	PMEG3005EH, PMEG3005EJ		-	30	V	
	PMEG4005EH, PMEG4005EJ		-	40	V	
I_F	forward current	$T_{sp} \leq 55\text{ °C}$	-	0.5	A	
I_{FRM}	repetitive peak forward current	$t_p \leq 1\text{ ms}; \delta \leq 0.25$	-	7	A	
I_{FSM}	non-repetitive peak forward current	$t = 8\text{ ms square wave}$	-	10	A	
P_{tot}	total power dissipation	$T_{amb} \leq 25\text{ °C}$				
	SOD123F		[1]	-	375	mW
			[2]	-	830	mW
	SOD323F		[1]	-	360	mW
			[2]	-	830	mW
T_j	junction temperature		-	150	°C	
T_{amb}	ambient temperature		-65	+150	°C	
T_{stg}	storage temperature		-65	+150	°C	

[1] Device mounted on an FR4 Printed-Circuit Board (PCB), single-sided copper, tin-plated and standard footprint.

[2] Device mounted on an FR4 PCB, single-sided copper, tin-plated, mounting pad for cathode 1 cm².

6. Thermal characteristics

Table 7. Thermal characteristics

Symbol	Parameter	Conditions	Min	Typ	Max	Unit
$R_{th(j-a)}$	thermal resistance from junction to ambient	in free air	[1][2]			
	SOD123F		-	-	330	K/W
	SOD323F		-	-	350	K/W
			[1][3]	-	-	150
$R_{th(j-sp)}$	thermal resistance from junction to solder point					
	SOD123F		-	-	60	K/W
	SOD323F		-	-	55	K/W

[1] Schottky barrier diodes thermal run-away has to be considered, as in some applications the reverse power losses P_R are a significant part of the total power losses. Nomograms for determining the reverse power losses P_R and $I_{F(AV)}$ rating will be available on request.

[2] Device mounted on an FR4 PCB, single-sided copper, tin-plated and standard footprint.

[3] Device mounted on an FR4 PCB, single-sided copper, tin-plated, mounting pad for cathode 1 cm².

7. Characteristics

Table 8. Characteristics
 $T_{amb} = 25\text{ }^{\circ}\text{C}$ unless otherwise specified.

Symbol	Parameter	Conditions	Min	Typ	Max	Unit		
V_F	forward voltage		[1]					
	PMEG2005EH, PMEG2005EJ		$I_F = 0.1\text{ mA}$	-	90	130	mV	
			$I_F = 1\text{ mA}$	-	150	190	mV	
			$I_F = 10\text{ mA}$	-	210	240	mV	
			$I_F = 100\text{ mA}$	-	280	330	mV	
			$I_F = 500\text{ mA}$	-	355	390	mV	
	PMEG3005EH, PMEG3005EJ		$I_F = 0.1\text{ mA}$	-	90	130	mV	
			$I_F = 1\text{ mA}$	-	150	200	mV	
			$I_F = 10\text{ mA}$	-	215	250	mV	
			$I_F = 100\text{ mA}$	-	285	340	mV	
			$I_F = 500\text{ mA}$	-	380	430	mV	
	PMEG4005EH, PMEG4005EJ		$I_F = 0.1\text{ mA}$	-	95	130	mV	
			$I_F = 1\text{ mA}$	-	155	210	mV	
			$I_F = 10\text{ mA}$	-	220	270	mV	
			$I_F = 100\text{ mA}$	-	295	350	mV	
			$I_F = 500\text{ mA}$	-	420	470	mV	
	I_R	reverse current		[1][2]				
		PMEG2005EH, PMEG2005EJ		$V_R = 10\text{ V}$	-	15	40	μA
				$V_R = 20\text{ V}$	-	40	200	μA
PMEG3005EH, PMEG3005EJ			$V_R = 10\text{ V}$	-	12	30	μA	
			$V_R = 30\text{ V}$	-	40	150	μA	
PMEG4005EH, PMEG4005EJ			$V_R = 10\text{ V}$	-	7	20	μA	
			$V_R = 40\text{ V}$	-	30	100	μA	
C_d	diode capacitance	$V_R = 1\text{ V}; f = 1\text{ MHz}$						
	PMEG2005EH, PMEG2005EJ		-	66	80	pF		
			-	55	70	pF		
	PMEG3005EH, PMEG3005EJ		-	43	50	pF		
-								

[1] Pulse test: $t_p \leq 300\text{ }\mu\text{s}$; $\delta \leq 0.02$.

[2] Schottky barrier rectifier thermal run-away has to be considered, as in some applications the reverse power losses P_R are a significant part of the total power losses. Nomograms for determining the reverse power losses P_R and $I_{F(AV)}$ rating will be available on request.

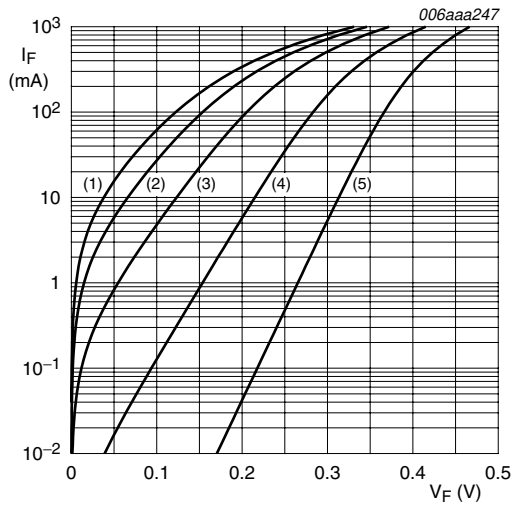

- (1) $T_{amb} = 150\text{ °C}$
- (2) $T_{amb} = 125\text{ °C}$
- (3) $T_{amb} = 85\text{ °C}$
- (4) $T_{amb} = 25\text{ °C}$
- (5) $T_{amb} = -40\text{ °C}$

Fig 1. PMEG2005EH, PMEG2005EJ: Forward current as a function of forward voltage; typical values

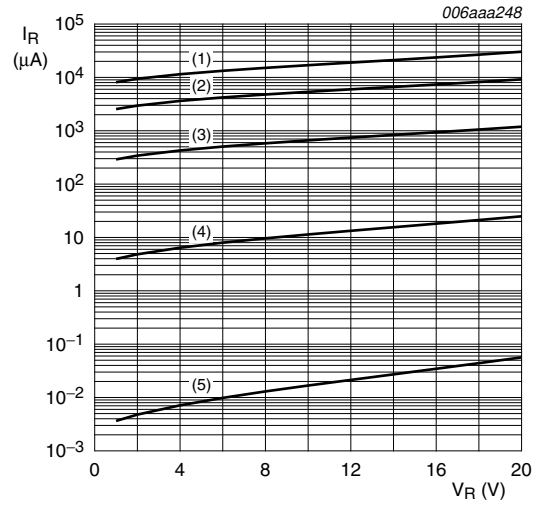

- (1) $T_{amb} = 150\text{ °C}$
- (2) $T_{amb} = 125\text{ °C}$
- (3) $T_{amb} = 85\text{ °C}$
- (4) $T_{amb} = 25\text{ °C}$
- (5) $T_{amb} = -40\text{ °C}$

Fig 2. PMEG2005EH, PMEG2005EJ: Reverse current as a function of reverse voltage; typical values

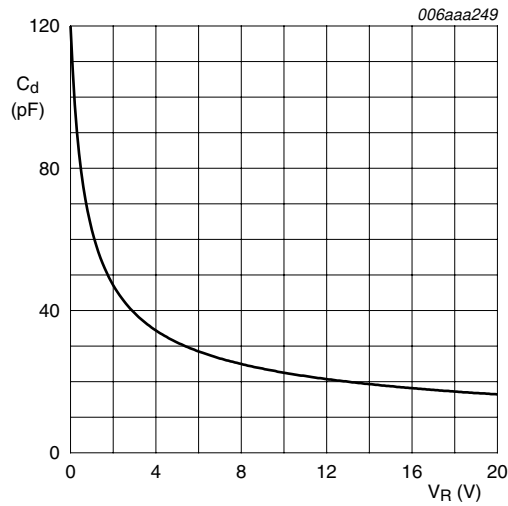

$T_{amb} = 25\text{ °C}; f = 1\text{ MHz}$

Fig 3. PMEG2005EH, PMEG2005EJ: Diode capacitance as a function of reverse voltage; typical values

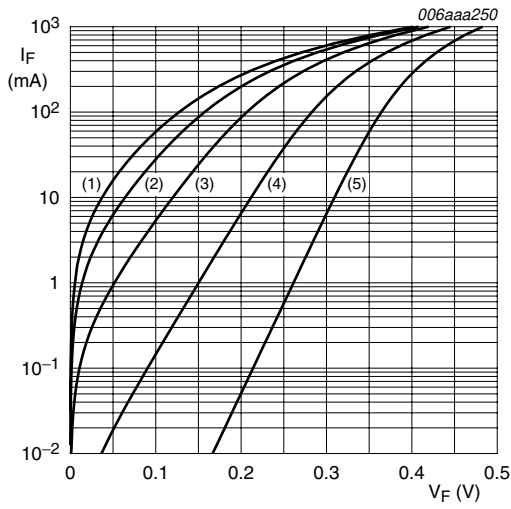

- (1) $T_{amb} = 150\text{ }^{\circ}\text{C}$
- (2) $T_{amb} = 125\text{ }^{\circ}\text{C}$
- (3) $T_{amb} = 85\text{ }^{\circ}\text{C}$
- (4) $T_{amb} = 25\text{ }^{\circ}\text{C}$
- (5) $T_{amb} = -40\text{ }^{\circ}\text{C}$

Fig 4. PMEG3005EH, PMEG3005EJ: Forward current as a function of forward voltage; typical values

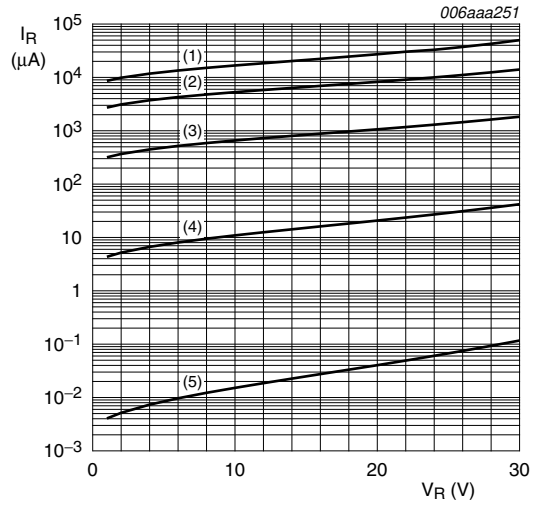

- (1) $T_{amb} = 150\text{ }^{\circ}\text{C}$
- (2) $T_{amb} = 125\text{ }^{\circ}\text{C}$
- (3) $T_{amb} = 85\text{ }^{\circ}\text{C}$
- (4) $T_{amb} = 25\text{ }^{\circ}\text{C}$
- (5) $T_{amb} = -40\text{ }^{\circ}\text{C}$

Fig 5. PMEG3005EH, PMEG3005EJ: Reverse current as a function of reverse voltage; typical values

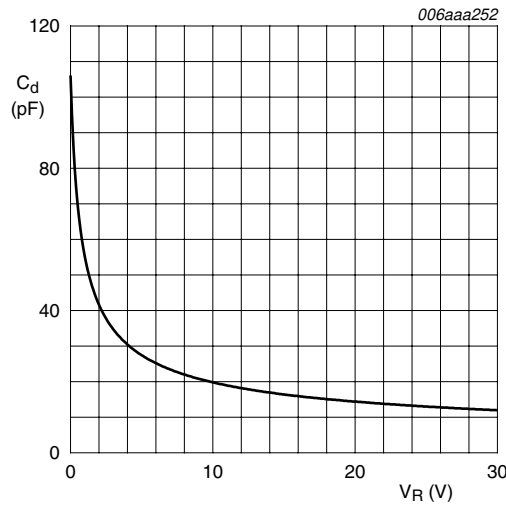

$T_{amb} = 25\text{ }^{\circ}\text{C}; f = 1\text{ MHz}$

Fig 6. PMEG3005EH, PMEG3005EJ: Diode capacitance as a function of reverse voltage; typical values

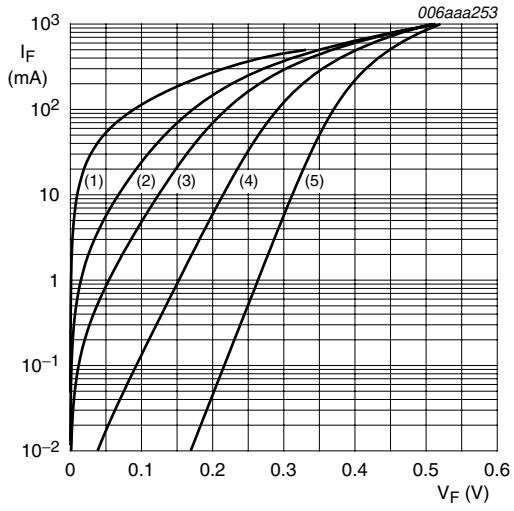

- (1) $T_{amb} = 150\text{ °C}$
- (2) $T_{amb} = 125\text{ °C}$
- (3) $T_{amb} = 85\text{ °C}$
- (4) $T_{amb} = 25\text{ °C}$
- (5) $T_{amb} = -40\text{ °C}$

Fig 7. PMEG4005EH, PMEG4005EJ: Forward current as a function of forward voltage; typical values

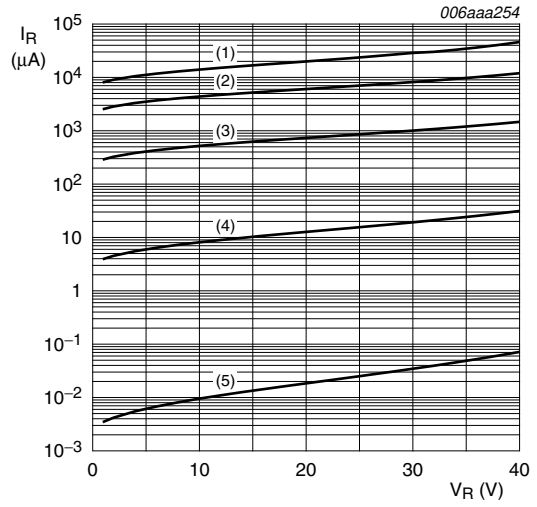

- (1) $T_{amb} = 150\text{ °C}$
- (2) $T_{amb} = 125\text{ °C}$
- (3) $T_{amb} = 85\text{ °C}$
- (4) $T_{amb} = 25\text{ °C}$
- (5) $T_{amb} = -40\text{ °C}$

Fig 8. PMEG4005EH, PMEG4005EJ: Reverse current as a function of reverse voltage; typical values

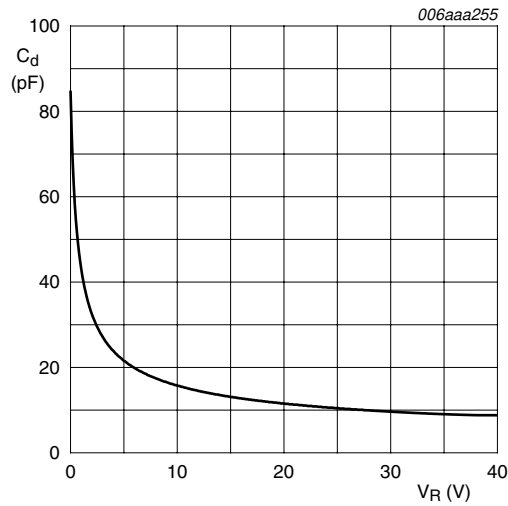

$T_{amb} = 25\text{ °C}; f = 1\text{ MHz}$

Fig 9. PMEG4005EH, PMEG4005EJ: Diode capacitance as a function of reverse voltage; typical values

8. Package outline

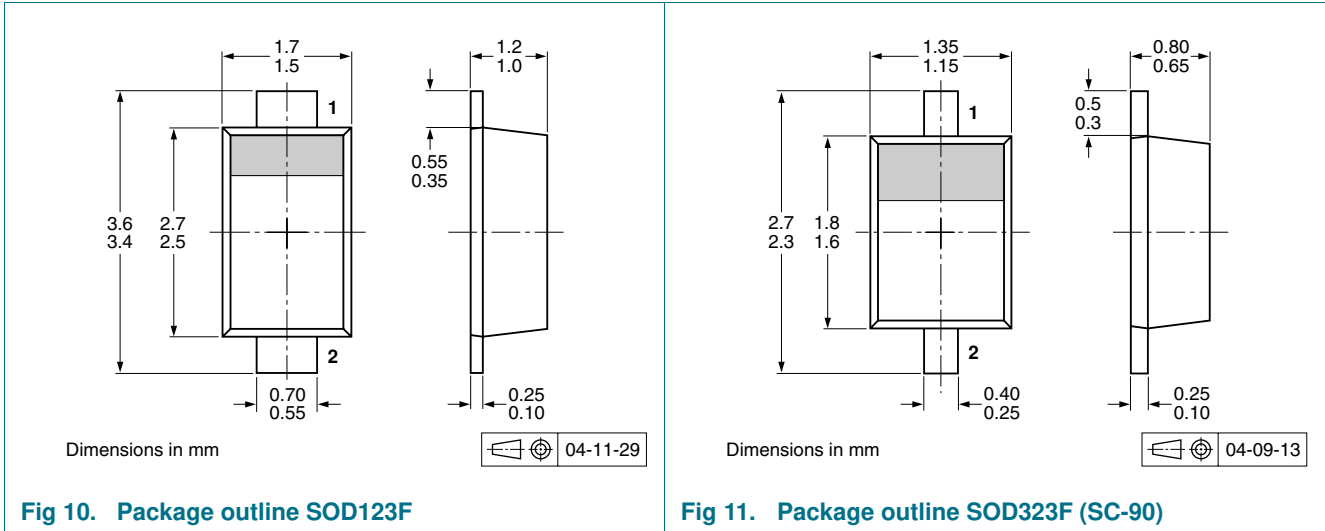

9. Packing information

Table 9. Packing methods

The indicated -xxx are the last three digits of the 12NC ordering code.^[1]

Type number	Package	Description	Packing quantity	
			3000	10000
PMEG2005EH	SOD123F	4 mm pitch, 8 mm tape and reel	-115	-135
PMEG3005EH				
PMEG4005EH				
PMEG2005EJ	SOD323F	4 mm pitch, 8 mm tape and reel	-115	-135
PMEG3005EJ				
PMEG4005EJ				

[1] For further information and the availability of packing methods, see [Section 13](#).

10. Soldering

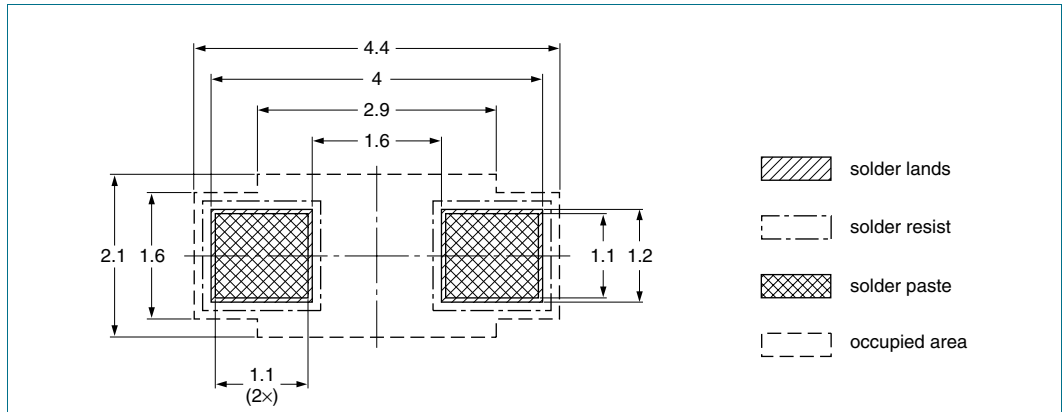

Reflow soldering is the only recommended soldering method.

Dimensions in mm

Fig 12. Reflow soldering footprint SOD123F

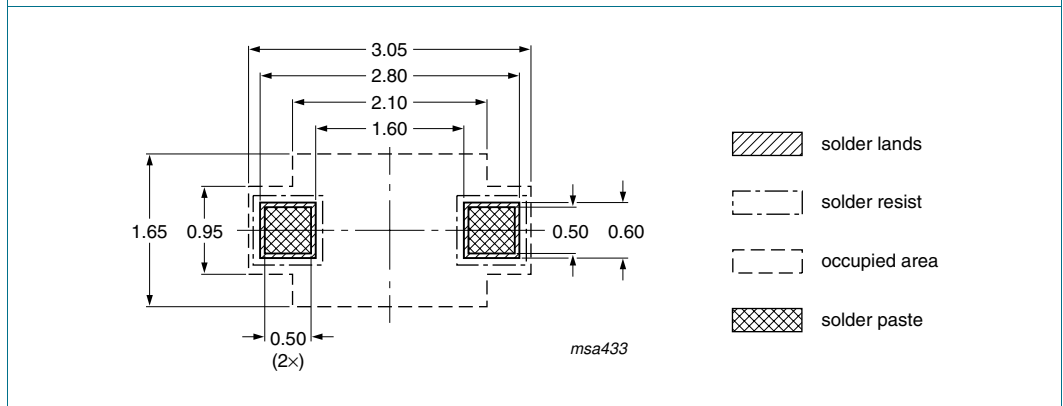

Reflow soldering is the only recommended soldering method.

Dimensions in mm

Fig 13. Reflow soldering footprint SOD323F (SC-90)

11. Revision history

Table 10. Revision history

Document ID	Release date	Data sheet status	Change notice	Supersedes
PMEGXX05EH_EJ_SER_2	20100113	Product data sheet	-	PMEGXX05EH_EJ_SER_1
Modifications:		<ul style="list-style-type: none">This data sheet was changed to reflect the new company name NXP Semiconductors, including new legal definitions and disclaimers. No changes were made to the technical content.		
PMEGXX05EH_EJ_SER_1	20050412	Product data sheet	-	-

12. Legal information

12.1 Data sheet status

Document status ^{[1][2]}	Product status ^[3]	Definition
Objective [short] data sheet	Development	This document contains data from the objective specification for product development.
Preliminary [short] data sheet	Qualification	This document contains data from the preliminary specification.
Product [short] data sheet	Production	This document contains the product specification.

[1] Please consult the most recently issued document before initiating or completing a design.

[2] The term 'short data sheet' is explained in section "Definitions".

[3] The product status of device(s) described in this document may have changed since this document was published and may differ in case of multiple devices. The latest product status information is available on the Internet at URL <http://www.nxp.com>.

12.2 Definitions

Draft — The document is a draft version only. The content is still under internal review and subject to formal approval, which may result in modifications or additions. NXP Semiconductors does not give any representations or warranties as to the accuracy or completeness of information included herein and shall have no liability for the consequences of use of such information.

Short data sheet — A short data sheet is an extract from a full data sheet with the same product type number(s) and title. A short data sheet is intended for quick reference only and should not be relied upon to contain detailed and full information. For detailed and full information see the relevant full data sheet, which is available on request via the local NXP Semiconductors sales office. In case of any inconsistency or conflict with the short data sheet, the full data sheet shall prevail.

12.3 Disclaimers

General — Information in this document is believed to be accurate and reliable. However, NXP Semiconductors does not give any representations or warranties, expressed or implied, as to the accuracy or completeness of such information and shall have no liability for the consequences of use of such information.

Right to make changes — NXP Semiconductors reserves the right to make changes to information published in this document, including without limitation specifications and product descriptions, at any time and without notice. This document supersedes and replaces all information supplied prior to the publication hereof.

Suitability for use — NXP Semiconductors products are not designed, authorized or warranted to be suitable for use in medical, military, aircraft, space or life support equipment, nor in applications where failure or malfunction of an NXP Semiconductors product can reasonably be expected to result in personal injury, death or severe property or environmental

damage. NXP Semiconductors accepts no liability for inclusion and/or use of NXP Semiconductors products in such equipment or applications and therefore such inclusion and/or use is at the customer's own risk.

Applications — Applications that are described herein for any of these products are for illustrative purposes only. NXP Semiconductors makes no representation or warranty that such applications will be suitable for the specified use without further testing or modification.

Limiting values — Stress above one or more limiting values (as defined in the Absolute Maximum Ratings System of IEC 60134) may cause permanent damage to the device. Limiting values are stress ratings only and operation of the device at these or any other conditions above those given in the Characteristics sections of this document is not implied. Exposure to limiting values for extended periods may affect device reliability.

Terms and conditions of sale — NXP Semiconductors products are sold subject to the general terms and conditions of commercial sale, as published at <http://www.nxp.com/profile/terms>, including those pertaining to warranty, intellectual property rights infringement and limitation of liability, unless explicitly otherwise agreed to in writing by NXP Semiconductors. In case of any inconsistency or conflict between information in this document and such terms and conditions, the latter will prevail.

No offer to sell or license — Nothing in this document may be interpreted or construed as an offer to sell products that is open for acceptance or the grant, conveyance or implication of any license under any copyrights, patents or other industrial or intellectual property rights.

Export control — This document as well as the item(s) described herein may be subject to export control regulations. Export might require a prior authorization from national authorities.

Quick reference data — The Quick reference data is an extract of the product data given in the Limiting values and Characteristics sections of this document, and as such is not complete, exhaustive or legally binding.

12.4 Trademarks

Notice: All referenced brands, product names, service names and trademarks are the property of their respective owners.

13. Contact information

For more information, please visit: <http://www.nxp.com>

For sales office addresses, please send an email to: salesaddresses@nxp.com

14. Contents

1	Product profile	1
1.1	General description	1
1.2	Features	1
1.3	Applications	1
1.4	Quick reference data	2
2	Pinning information	2
3	Ordering information	2
4	Marking	3
5	Limiting values	3
6	Thermal characteristics	4
7	Characteristics	5
8	Package outline	9
9	Packing information	9
10	Soldering	10
11	Revision history	11
12	Legal information	12
12.1	Data sheet status	12
12.2	Definitions	12
12.3	Disclaimers	12
12.4	Trademarks	12
13	Contact information	12
14	Contents	13

Please be aware that important notices concerning this document and the product(s) described herein, have been included in section 'Legal information'.



© NXP B.V. 2010.

All rights reserved.

For more information, please visit: <http://www.nxp.com>

For sales office addresses, please send an email to: salesaddresses@nxp.com

Date of release: 13 January 2010

Document identifier: PMEGXX05EH_EJ_SER_2