



Chipsmall Limited consists of a professional team with an average of over 10 year of expertise in the distribution of electronic components. Based in Hongkong, we have already established firm and mutual-benefit business relationships with customers from,Europe,America and south Asia,supplying obsolete and hard-to-find components to meet their specific needs.

With the principle of “Quality Parts,Customers Priority,Honest Operation,and Considerate Service”,our business mainly focus on the distribution of electronic components. Line cards we deal with include Microchip,ALPS,ROHM,Xilinx,Pulse,ON,Everlight and Freescale. Main products comprise IC,Modules,Potentiometer,IC Socket,Relay,Connector.Our parts cover such applications as commercial,industrial, and automotives areas.

We are looking forward to setting up business relationship with you and hope to provide you with the best service and solution. Let us make a better world for our industry!



Contact us

Tel: +86-755-8981 8866 Fax: +86-755-8427 6832

Email & Skype: info@chipsmall.com Web: www.chipsmall.com

Address: A1208, Overseas Decoration Building, #122 Zhenhua RD., Futian, Shenzhen, China





Features

- Using a dedicated IC, the operation time variance is $\pm 0.5\%$.
- Using the slide, time range switching is easy. Moreover, the scale numbers on the dial and time units can be switched automatically.

| Button position | | | | |
|-----------------|---------------|-------------|---------------|-------------|
| Type | | | | |
| 10M type | 0.05S to 1.0S | 0.5S to 10S | 0.05M to 1.0M | 0.5M to 10M |
| 30M type | 0.15S to 3.0S | 1.5S to 30S | 0.15M to 3.0M | 1.5M to 30M |
| 10H type | 0.05M to 1.0M | 0.5M to 10M | 0.05H to 1.0H | 0.5H to 10H |
| 30H type | 0.15M to 3.0M | 1.5M to 30M | 0.15H to 3.0H | 1.5H to 30H |

- You can use for embedding if you use together with the appropriate flush type mounting frame designed for that purpose (sold separately).

Time selectable

Product types

| Product name | Operating voltage | 10M type | 30M type | 10H type | 30H type |
|--------------|-------------------|----------------|----------------|----------------|----------------|
| | | Part No. | Part No. | Part No. | Part No. |
| PMH timer | 100 to 120 V AC | PMH-10M-AC120V | PMH-30M-AC120V | PMH-10H-AC120V | PMH-30H-AC120V |
| | 200 to 240 V AC | PMH-10M-AC220V | PMH-30M-AC220V | PMH-10H-AC220V | PMH-30H-AC220V |
| | 12 V DC | PMH-10M-DC12V | PMH-30M-DC12V | PMH-10H-DC12V | PMH-30H-DC12V |
| | 24 V DC | PMH-10M-DC24V | PMH-30M-DC24V | PMH-10H-DC24V | PMH-30H-DC24V |
| | 48 V DC | PMH-10M-DC48V | PMH-30M-DC48V | PMH-10H-DC48V | PMH-30H-DC48V |
| | 100 to 110 V DC | PMH-10M-DC100V | PMH-30M-DC100V | PMH-10H-DC100V | PMH-30H-DC100V |

- Notes: 1. 24 V AC type can also be ordered. Please inquire about pricing and any other details.
 2. If embedding, please use the flush type mounting frame for that purpose.
 3. Please order with a "9" at the end of the part number for UL and CSA certified products. Please inquire about pricing and any other details.

Time range

| Time range | Scale intervals |
|------------|-----------------|
| 1.0 | 0.05 |
| 3.0 | 0.1 |
| 10 | 0.5 |
| 30 | 1 |

Operation mode

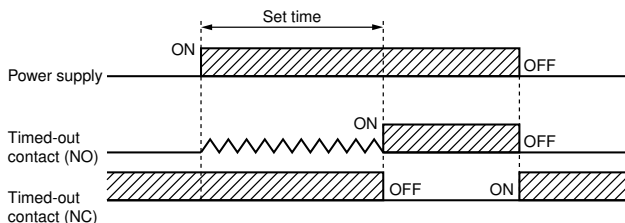

Specifications

| Type | | PMH Timers | |
|---------------------------------------|--|---|-----------------------------------|
| | | AC operating type | DC operating type |
| Rated operating voltage | | 100 to 120V, 200 to 240V (50/60Hz common) | 12V, 24V, 48V, 100 to 110V |
| Rated power consumption | | Max. 3VA | Max. 2W |
| Rated control capacity | | 7A 250V AC (resistive load) | |
| Operation mode | | ON-delay | |
| Time accuracy | Operating time fluctuation & Power off time change error | [Except 1s range] Within $\pm 0.5\%$ * [1s range]: Within $\pm(0.5\%+10\text{ms})$ (power off time change at the range of 0.1 s to 1 h) | |
| | Voltage error | [Except 1s range] Within $\pm 0.5\%$ * [1s range]: Within $\pm(0.5\%+10\text{ms})$ (at the operating voltage changes between -20 to $+10\%$) | |
| | Temperature error | Within $\pm 5\%$ (at 20°C 68°F ambient temp. at the range of -10 to $+50^\circ\text{C}$ $+14$ to $+122^\circ\text{F}$) | |
| | Setting error | Within $\pm 10\%$ (Full-scale value) | |
| Output arrangement | | Timed-out 2 Form C | |
| Contact resistance (Initial value) | | Max. $50\text{m}\Omega$ (By voltage drop 6V DC 1A) | |
| Expected life (min. operations) | Mechanical (constant) | Min. 5×10^7 | |
| | Electrical (constant) | Min. 2×10^5 (at rated control capacity) | |
| Allowable operating voltage range | | 80 to 110% of rated operating voltage | |
| Insulation resistance (Initial value) | | Min. $100\text{M}\Omega$ (at 500V DC) Between input and output Between contact sets Between contacts | |
| Breakdown voltage (Initial value) | | 2000Vrms for 1min Between input and output 2000Vrms for 1min Between contact sets 1000Vrms for 1min Between contacts | |
| Power off time | | Max. 0.1s | |
| Vibration resistance | Functional | 10 to 55Hz: 1 cycle/min double amplitude of 0.5mm (10min on 3 axes) | |
| | Destructive | 10 to 55Hz: 1 cycle/min double amplitude of 0.75mm (1h on 3 axes) | |
| Shock resistance | Functional | Min. 98m/s^2 (4 times on 3 axes) | |
| | Destructive | Min. 980m/s^2 (5 times on 3 axes) | |
| Ambient temperature | | -10 to 50°C $+14$ to 122°F | |
| Ambient humidity | | 30 to 85% RH (at 20°C 68°F , non-condensing) | |
| Ripple factor | | — | Full-wave rectified (Approx. 48%) |

Dimensions (mm inch)

The CAD data of the products with a **CAD Data** mark can be downloaded from: <http://panasonic-electric-works.net/ac>

General tolerance: $\pm 1.0 \pm 0.039$

CAD Data

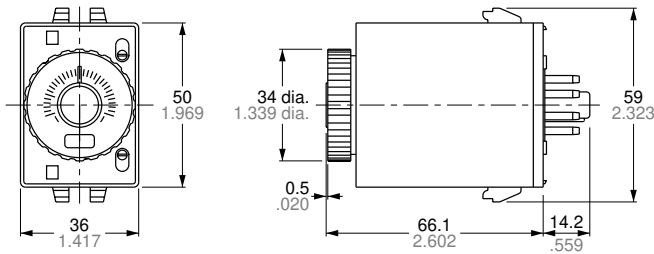

Terminal layouts and Wiring diagrams

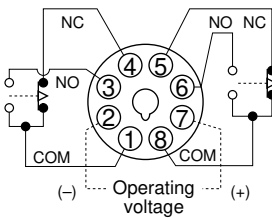

▲▲▲ : Timed cut contact

○ ○ : Instantaneous contact

Note: For the DC type, No. 2 terminal is (-).

*For installation parts, please refer to "PMH TIMER OPTIONS" on page 168.

PMH TIMER OPTIONS

Flush Type

■ Flush type mounting frame

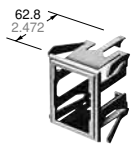
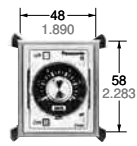
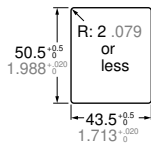
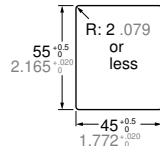
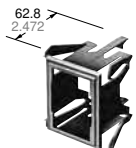
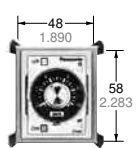
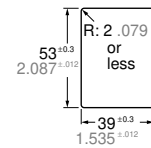
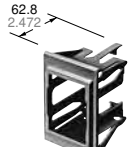
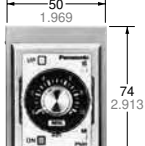
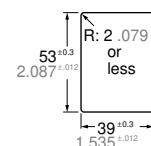
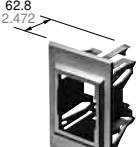
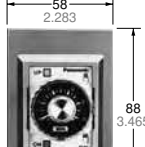
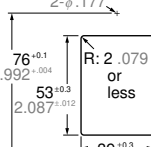
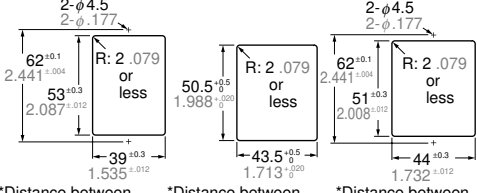
| Appearance | Color | Model number | Front View (Installing onto control panel) | Mounting Hole Dimensions (Unit: mm inch) | |
|--|-------------|----------------------|---|---|---|
| | | | | Recommended Hole (For newly designed frame) | Applicable Mounting Hole (For installing in the old hole) |
|  | Gray | AT7851 N-TF-H-GR |  |  |  |
| | Black | AT7852 N-TF-H-B | | | |
| | Silver Gray | AT7853 N-TF-H-SG | | | |
|  | Gray | AT7811 N-TF-K-GR |  |  | <p>*Distance between parallel drilled holes: 6.5 mm or more</p> |
| | Black | AT7812 N-TF-K-B | | | |
| | Silver Gray | AT7813 N-TF-K-SG | | | |
|  | Gray | AT7821 N-TF-YC-GR |  |  | <p>*Distance between parallel drilled holes: 13 mm or more</p> |
| | Black | AT7822 N-TF-YC-B | | | |
| | Silver Gray | AT7823 N-TF-YC-SG | | | |
|  | Gray | AT7831 N-TF-Y-GR |  |  |  |

Notes:

1. The thickness of all applicable panels ranges from 1.0 to 3.5 mm .039 to .138 inch.
2. * indicates the distance between the mounting holes which are parallel cut on the panel.

Installation

1. Insert the mounting frame surface into the panel from its front surface.

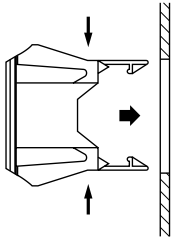

Note: The panel which is installed onto the flush type mounting frame for the timer cannot be inserted. (However, the installation order is not specified when the flush type mounting frame (type S) is used.)

2. After installing the panel, insert the timer to be used from the back of the panel.

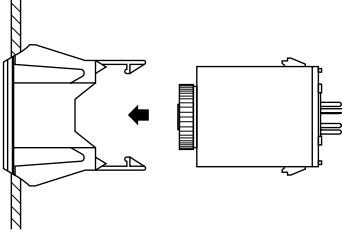

When an applicable timer comes in contact with the collar of the mounting frame, stop the timer by pressing the upper and lower hooks in the direction indicated by arrow. Use rear terminal socket (AT78041) or 8P cap (AD8-RC) for the connection wiring.

3. Hang the hooks on the timer base to secure the timer to the flush type mounting frame.

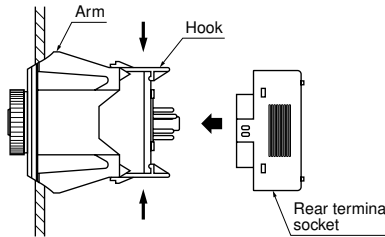
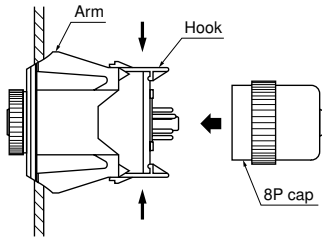

Removal

Remove the timer in the reverse order of installation.

• Compact timer protective cover

Model number: N-TC



■ Features

1. The cover prevents the timer from operating improperly after setting the time. It also works as a compact dust cover.
2. The cover is applicable for all types of the fingertip flush type mounting frames for the compact timer.

■ Installation

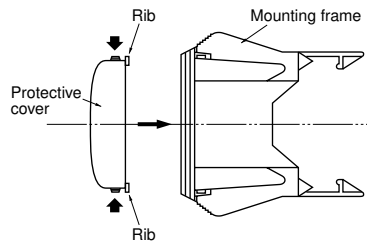

Press the points on the protective cover (indicated by arrows) to bend the ribs, and hook the ribs inside the mounting frame window. The protective cover can be installed if the timer is inserted into the mounting frame.

■ Dimensions (Unit: mm inch)

Tolerance: $\pm 0.3 \pm .012$

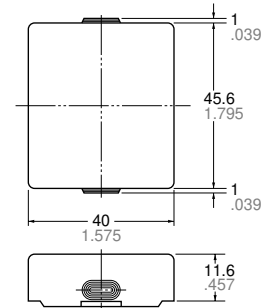

• **8P cap** When a flush type mounting frame is used for the exposed type, 8P cap should be installed.

Model number: AD8-RC

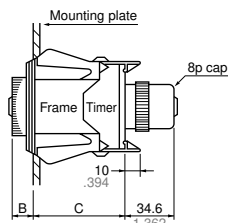

The dimensions B and C are shown in the table below.

(Unit: mm, inch)

| Mounting frame to be used | Dimension B | Dimension C |
|----------------------------------|-------------|-------------|
| Type H Type K | 13.1 | 52.8 |
| Type MHP Type MHP-M Type S | 14.6 | 51.3 |

• **Rear terminal socket: M3.5**
Applicable for 8-pin type

Tolerance: $\pm 1 \pm .039$

Model number: AT78041

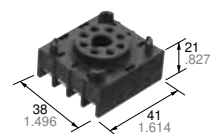

PMH TIMER OPTIONS

■ Applicable for the exposed type plug-in and stand-up type timers (PMH)

• DIN terminal socket: M3.5

Tolerance: $\pm 0.5 \pm .020$

Model number: AT8-RFD

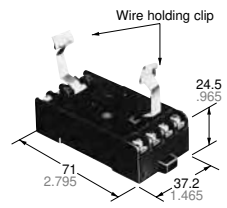

All types of our compact size timers can be easily installed on the DIN rail by using this terminal socket.

When installing the terminal socket:

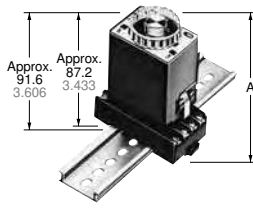

The height of the DIN rail should be added to the overall height A.

Mounting hole dimensions Without DIN rails

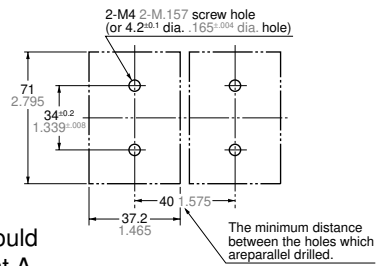

Wiring diagrams (TOP VIEW)

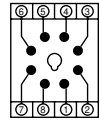

Note: Terminal number on the main body are identical to those on the terminal socket.

• Mounting rail (Applicable for DIN and IEC standards)

Model number: AT8-DLA1



Length: 1 m 3.28 ft.
Aluminum

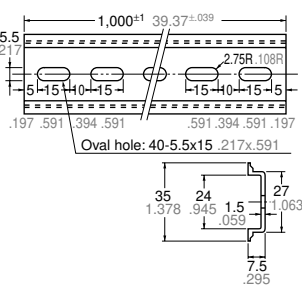

• Fastening plate

Model number: ATA4806

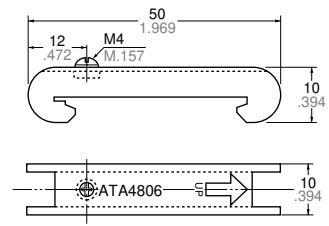

• GT pipe socket

Tolerance: $\pm 0.5 \pm .020$

Model number: AW68102

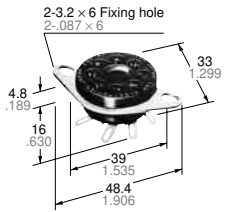

Mounting hole dimensions

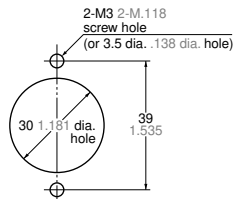

Pitch for installing the timer
When installing the clips vertically, the pitch for the timer should be 79 mm 3.110 inch or more.

PMH TIMER OPTIONS

■ Accessory

Used for the exposed type

(Unit: mm inch), General tolerance: $\pm 1 \pm .039$

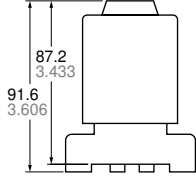
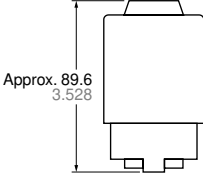
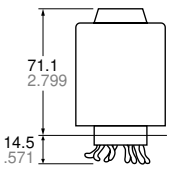
| | | | |
|---|---|---|--|
|  | <ul style="list-style-type: none"> • DIN terminal socket  | <ul style="list-style-type: none"> • Timer rear terminal socket  | <ul style="list-style-type: none"> • GT pipe socket  |
| <p>Model number</p> | <p>AT8-RFD</p> | <p>AT78041</p> | <p>AW68102</p> |

For details, please refer to "PMH TIMER OPTIONS" on page 170.

Used for the flush type

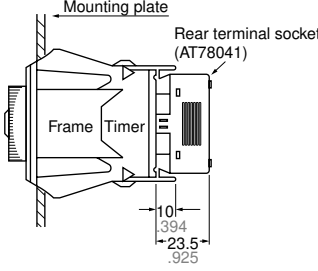
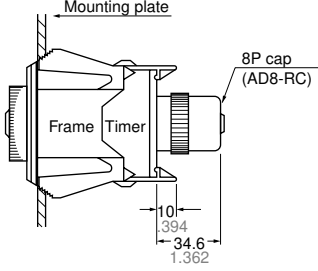
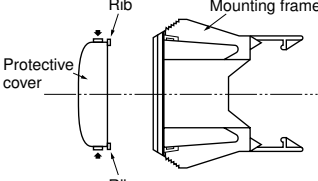
| | | | |
|--|---|--|--|
|  <p>Flush type mounting frame</p> | <ul style="list-style-type: none"> • Compact timer rear terminal socket  | <ul style="list-style-type: none"> • 8P cap  | <ul style="list-style-type: none"> • Compact timer protective cover  |
| <p>Model number</p> | <p>AT78041</p> | <p>AD8-RC</p> | <p>N-TC</p> |

For details, please refer to "PMH TIMER OPTIONS" on page 168.

PRECAUTIONS IN USING PMH TIMERS

Precautions during usage

- In order to maintain the characteristics of PHM timer, do not remove the case.
- Please use within an ambient temperature range of -10 to $+50^{\circ}\text{C}$ $+14$ to 122°F and in humidity no greater than 85% RH.
- Prevent using PMH timer in such places where flammable or corrosive gas is generated, a lot of dust exists or considerable shock and vibration occur.
- Since the main body cover is made of polycarbonate resin, prevent contact with organic solvents such as methyl alcohol, benzene and thinner, or strong alkali materials such as ammonia and caustic soda.
- Do not make direct solder connections to the round pins.
- Carefully verify the terminal numbers when wiring the terminal socket and cap.
- When rotating the knob, note that there are stoppers located just past the “0” side and the full scale side. Therefore, do not use unreasonable force.
- Please use with a time setting that is no less than the minimum time limit. The minimum time limit is indicated on the dial by the \downarrow mark.
- The contacts will not operate if the needle is adjusted to the “0” position when the power is off.
- **Phase synchronization for AC load switching**
When timer output contact will be synchronized to the AC power phase, the electrical life may be compromised and locking (contact reset failure) may occur due to contact welding or contact transference. Therefore, please conduct tests using actual equipment.