



Chipsmall Limited consists of a professional team with an average of over 10 year of expertise in the distribution of electronic components. Based in Hongkong, we have already established firm and mutual-benefit business relationships with customers from,Europe,America and south Asia,supplying obsolete and hard-to-find components to meet their specific needs.

With the principle of “Quality Parts,Customers Priority,Honest Operation,and Considerate Service”,our business mainly focus on the distribution of electronic components. Line cards we deal with include Microchip,ALPS,ROHM,Xilinx,Pulse,ON,Everlight and Freescale. Main products comprise IC,Modules,Potentiometer,IC Socket,Relay,Connector.Our parts cover such applications as commercial,industrial, and automotives areas.

We are looking forward to setting up business relationship with you and hope to provide you with the best service and solution. Let us make a better world for our industry!



Contact us

Tel: +86-755-8981 8866 Fax: +86-755-8427 6832

Email & Skype: info@chipsmall.com Web: www.chipsmall.com

Address: A1208, Overseas Decoration Building, #122 Zhenhua RD., Futian, Shenzhen, China



PQxxxDNA1ZPH Series

Compact Surface Mount type
Low Power-Loss Voltage Regulators

■ Features

1. Output current : 1A
2. High isolation voltage V_{IN} : MAX. 24 V
3. Low dissipation current
(Dissipation current at no load: MAX. 8mA
Output OFF-state dissipation current: MAX. 5 μ A)
4. Built-in ON/OFF function
5. Built-in overcurrent and overheat protection functions
6. Built-in ASO protection function
7. Ceramic capacitor compatible
8. RoHS directive compliant

■ Applications

1. AV equipment
2. OA equipment

■ Model Line-up

Output Voltage (TYP.)	Model No.
3.3V	PQ033DNA1ZPH
5.0V	PQ050DNA1ZPH
8.0V	PQ080DNA1ZPH
9.0V	PQ090DNA1ZPH
12.0V	PQ120DNA1ZPH

■ Absolute Maximum Ratings

($T_a=25^{\circ}\text{C}$)

Parameter	Symbol	Rating	Unit
*1 Input voltage	V_{IN}	24	V
*1 Output control voltage	V_C	24	V
Output current	I_O	1	A
*2 Power dissipation	P_D	8	W
*3 Junction temperature	T_j	150	$^{\circ}\text{C}$
Operating temperature	T_{opr}	-40 to +85	$^{\circ}\text{C}$
Storage temperature	T_{stg}	-40 to +150	$^{\circ}\text{C}$
Soldering temperature	T_{sol}	260(10s)	$^{\circ}\text{C}$

*1 All are open except GND and applicable terminals.
*2 P_D : With infinite heat sink
*3 Overheat protection may operate at T_j : 125 $^{\circ}\text{C}$ to 150 $^{\circ}\text{C}$

■ Outline Dimensions

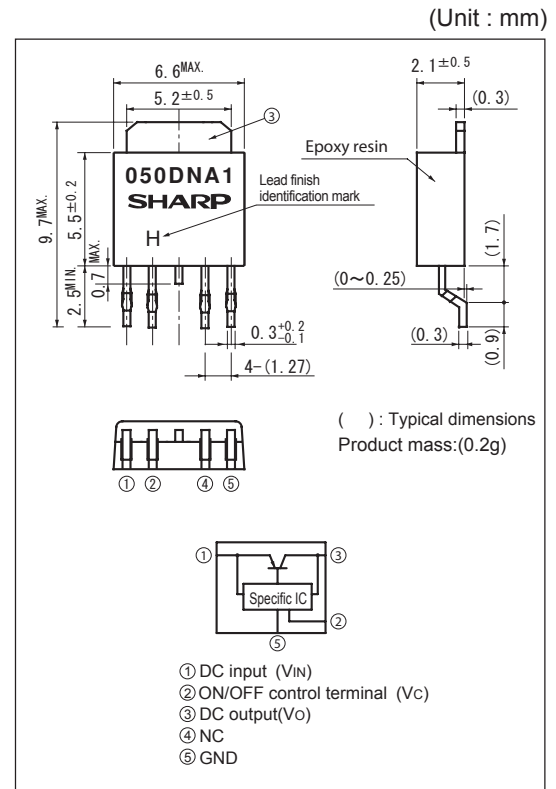

Lead finish: Lead-free solder plating
(Composition: Sn2Cu)

Notice The content of data sheet is subject to change without prior notice.

In the absence of confirmation by device specification sheets, SHARP takes no responsibility for any defects that may occur in equipment using any SHARP devices shown in catalogs, data books, etc. Contact SHARP in order to obtain the latest device specification sheets before using any SHARP device.

Electrical Characteristics

(1) PQ033DNA1ZPH

(Unless otherwise specified, condition shall be $V_{IN}=5V, I_o=0.5A, V_C=2.7V, T_a=25^\circ C$)

Parameter	Symbol	Conditions	MIN.	TYP.	MAX.	Unit
Output voltage	V_O	-	3.218	3.3	3.382	V
Load regulation	Reg_L	$I_o=5mA$ to 1A	-	0.2	1.0	%
Line regulation	Reg_l	$V_{IN}=4$ to 14V, $I_o=5mA$	-	0.2	1.0	%
Temperature coefficient of output voltage	$T_C V_O$	$T_j=0$ to $+125^\circ C$, $I_o=5mA$	-	± 0.01	-	$\%/^\circ C$
Ripple rejection	RR	Refer to Fig.3	-	60	-	dB
Dropout voltage	V_{I-O}	$V_{IN}=3.5V, I_o=0.5A$	-	0.2	0.5	V
*5 ON-state voltage for control	$V_{C(ON)}$	-	2.0	-	-	V
ON-state current for control	$I_{C(ON)}$	$V_C=2.7V$	-	-	200	μA
OFF-state voltage for control	$V_{C(OFF)}$	-	-	-	0.8	V
OFF-state current for control	$I_{C(OFF)}$	$V_C=0.4V$	-	-	2	μA
Quiescent current	I_q	$I_o=0A$	-	4	8	mA
Output OFF-state dissipation current	I_{qs}	$I_o=0A, V_C=0.4V$	-	-	5	μA

*5 In case of opening control terminal ②, output voltage turns off

(2) PQ050DNA1ZPH

(Unless otherwise specified, condition shall be $V_{IN}=7V, I_o=0.5A, V_C=2.7V, T_a=25^\circ C$)

Parameter	Symbol	Conditions	MIN.	TYP.	MAX.	Unit
Output voltage	V_O	-	4.875	5.0	5.125	V
Load regulation	Reg_L	$I_o=5mA$ to 1A	-	0.2	1.0	%
Line regulation	Reg_l	$V_{IN}=6$ to 16V, $I_o=5mA$	-	0.2	1.0	%
Temperature coefficient of output voltage	$T_C V_O$	$T_j=0$ to $+125^\circ C$, $I_o=5mA$	-	± 0.01	-	$\%/^\circ C$
Ripple rejection	RR	Refer to Fig.3	-	60	-	dB
Dropout voltage	V_{I-O}	*4, $I_o=0.5A$	-	0.2	0.5	V
*5 ON-state voltage for control	$V_{C(ON)}$	-	2.0	-	-	V
ON-state current for control	$I_{C(ON)}$	$V_C=2.7V$	-	-	200	μA
OFF-state voltage for control	$V_{C(OFF)}$	-	-	-	0.8	V
OFF-state current for control	$I_{C(OFF)}$	$V_C=0.4V$	-	-	2	μA
Quiescent current	I_q	$I_o=0A$	-	4	8	mA
Output OFF-state dissipation current	I_{qs}	$I_o=0A, V_C=0.4V$	-	-	5	μA

*4 Input voltage shall be the value when output voltage is 95% in comparison with the initial value.

*5 In case of opening control terminal ②, output voltage turns off

(3) PQ080DNA1ZPH

(Unless otherwise specified, condition shall be $V_{IN}=10V, I_o=0.5A, V_C=2.7V, T_a=25^\circ C$)

Parameter	Symbol	Conditions	MIN.	TYP.	MAX.	Unit
Output voltage	V_O	-	7.8	8.0	8.2	V
Load regulation	Reg_L	$I_o=5mA$ to 1A	-	0.2	1.0	%
Line regulation	Reg_l	$V_{IN}=9$ to 19V, $I_o=5mA$	-	0.2	1.0	%
Temperature coefficient of output voltage	$T_C V_O$	$T_j=0$ to $+125^\circ C$, $I_o=5mA$	-	± 0.01	-	$\%/^\circ C$
Ripple rejection	RR	Refer to Fig.3	-	60	-	dB
Dropout voltage	V_{I-O}	*4, $I_o=0.5A$	-	0.2	0.5	V
*5 ON-state voltage for control	$V_{C(ON)}$	-	2.0	-	-	V
ON-state current for control	$I_{C(ON)}$	$V_C=2.7V$	-	-	200	μA
OFF-state voltage for control	$V_{C(OFF)}$	-	-	-	0.8	V
OFF-state current for control	$I_{C(OFF)}$	$V_C=0.4V$	-	-	2	μA
Quiescent current	I_q	$I_o=0A$	-	4	8	mA
Output OFF-state dissipation current	I_{qs}	$I_o=0A, V_C=0.4V$	-	-	5	μA

*4 Input voltage shall be the value when output voltage is 95% in comparison with the initial value.

*5 In case of opening control terminal ②, output voltage turns off

(4) PQ090DNA1ZPH

(Unless otherwise specified, condition shall be $V_{IN}=11V, I_o=0.5A, V_c=2.7V, T_a=25^{\circ}C$)

Parameter	Symbol	Conditions	MIN.	TYP.	MAX.	Unit
Output voltage	V_o	-	8.775	9.0	9.225	V
Load regulation	$RegL$	$I_o=5mA$ to 1A	-	0.2	1.0	%
Line regulation	$Regl$	$V_{IN}=10$ to 20V, $I_o=5mA$	-	0.2	1.0	%
Temperature coefficient of output voltage	$TcVo$	$T_j=0$ to $+125^{\circ}C, I_o=5mA$	-	± 0.01	-	%/ $^{\circ}C$
Ripple rejection	RR	Refer to Fig.3	-	60	-	dB
Dropout voltage	V_{I-O}	*4, $I_o=0.5A$	-	0.2	0.5	V
*5 ON-state voltage for control	$V_{C(ON)}$	-	2.0	-	-	V
ON-state current for control	$I_{C(ON)}$	$V_c=2.7V$	-	-	200	μA
OFF-state voltage for control	$V_{C(OFF)}$	-	-	-	0.8	V
OFF-state current for control	$I_{C(OFF)}$	$V_c=0.4V$	-	-	2	μA
Quiescent current	I_q	$I_o=0A$	-	4	8	mA
Output OFF-state dissipation current	I_{qs}	$I_o=0A, V_c=0.4V$	-	-	5	μA

*4 Input voltage shall be the value when output voltage is 95% in comparison with the initial value.

*5 In case of opening control terminal ②, output voltage turns off

(5) PQ120DNA1ZPH

(Unless otherwise specified, condition shall be $V_{IN}=14V, I_o=0.5A, V_c=2.7V, T_a=25^{\circ}C$)

Parameter	Symbol	Conditions	MIN.	TYP.	MAX.	Unit
Output voltage	V_o	-	11.7	12.0	12.3	V
Load regulation	$RegL$	$I_o=5mA$ to 1A	-	0.2	1.0	%
Line regulation	$Regl$	$V_{IN}=13$ to 23V, $I_o=5mA$	-	0.2	1.0	%
Temperature coefficient of output voltage	$TcVo$	$T_j=0$ to $+125^{\circ}C, I_o=5mA$	-	± 0.01	-	%/ $^{\circ}C$
Ripple rejection	RR	Refer to Fig.3	-	60	-	dB
Dropout voltage	V_{I-O}	*4, $I_o=0.5A$	-	0.2	0.5	V
*5 ON-state voltage for control	$V_{C(ON)}$	-	2.0	-	-	V
ON-state current for control	$I_{C(ON)}$	$V_c=2.7V$	-	-	200	μA
OFF-state voltage for control	$V_{C(OFF)}$	-	-	-	0.8	V
OFF-state current for control	$I_{C(OFF)}$	$V_c=0.4V$	-	-	2	μA
Quiescent current	I_q	$I_o=0A$	-	4	8	mA
Output OFF-state dissipation current	I_{qs}	$I_o=0A, V_c=0.4V$	-	-	5	μA

*4 Input voltage shall be the value when output voltage is 95% in comparison with the initial value.

*5 In case of opening control terminal ②, output voltage turns off

Fig.1 Example of application

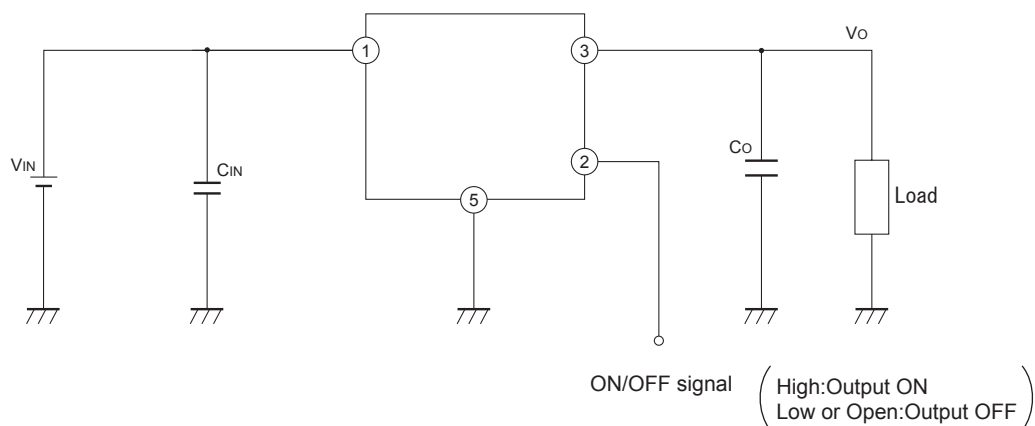

Fig.2 Test Circuit

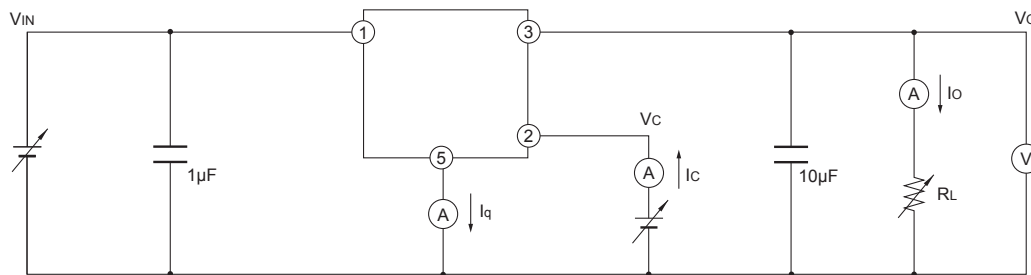
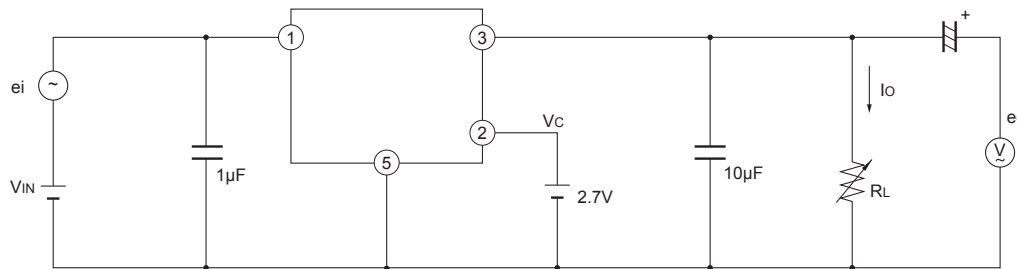
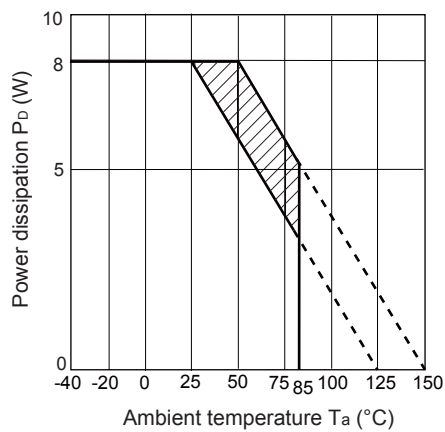

Fig.3 Test Circuit for Ripple Rejection



$f=120\text{Hz}(\text{sine wave})$
 $e_i(\text{rms})=0.5\text{V}$
 $V_{IN}=5\text{V}(\text{PQ033DNA1ZPH})$
 $7\text{V}(\text{PQ050DNA1ZPH})$
 $10\text{V}(\text{PQ080DNA1ZPH})$
 $11\text{V}(\text{PQ090DNA1ZPH})$
 $14\text{V}(\text{PQ120DNA1ZPH})$
 $I_O=0.3\text{A}$
 $RR=20\log(e_i(\text{rms})/e_o(\text{rms}))$

Fig.4 Power Dissipation vs. Ambient Temperature



Note) Oblique line portion: Overheat protection may operate in this area.

Fig.5 Overcurrent Protection Characteristics (PQ033DNA1ZPH)

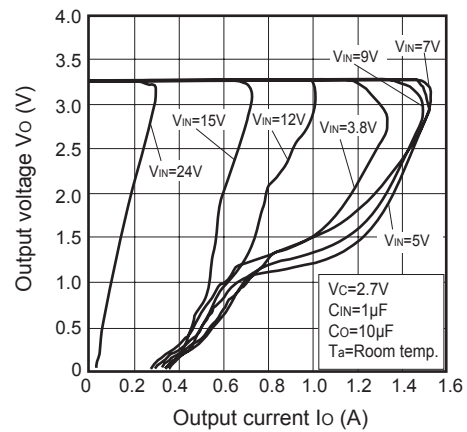

Fig.6 Overcurrent Protection Characteristics (PQ050DNA1ZPH)

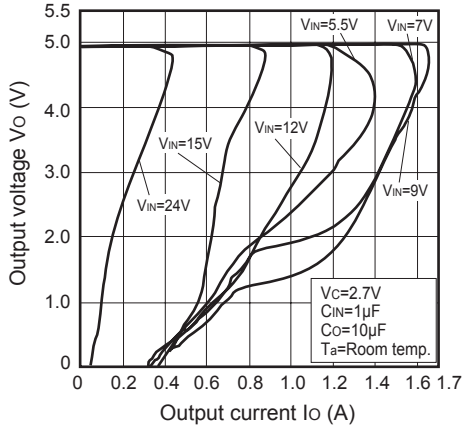

Fig.7 Overcurrent Protection Characteristics (PQ090DNA1ZPH)

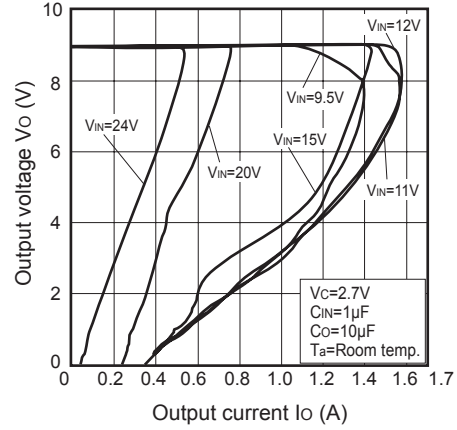

Fig.8 Overcurrent Protection Characteristics (PQ120DNA1ZPH)

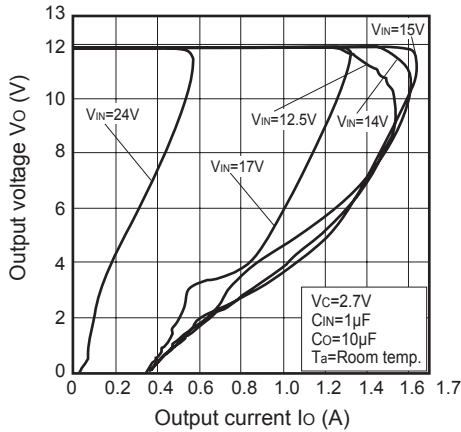

Fig.9 Output Voltage vs. Ambient Temperature (PQ120DNA1ZPH)

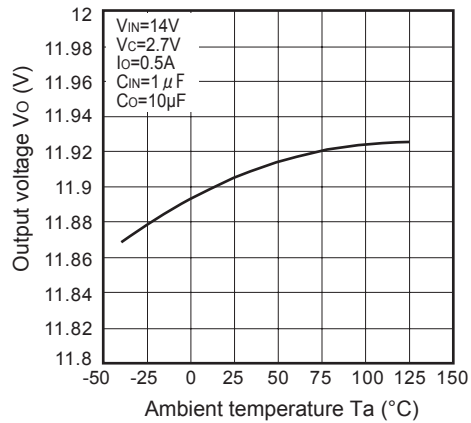

Fig.10 Output Voltage vs. Input Voltage (PQ120DNA1ZPH)

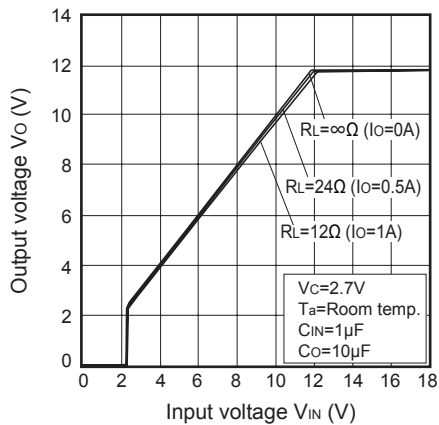

Fig.11 Circuit Operating Current vs. Input Voltage (PQ120DNA1ZPH)

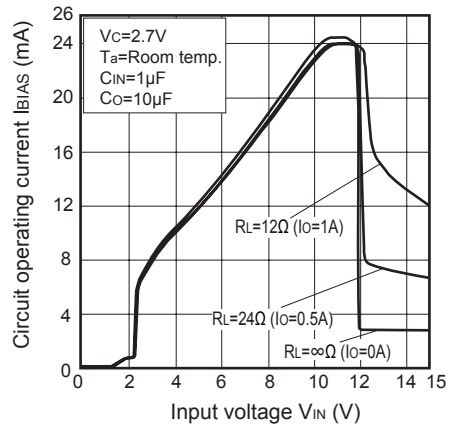

Fig.12 Quiescent Current vs. Ambient Temperature (PQ120DNA1ZPH)

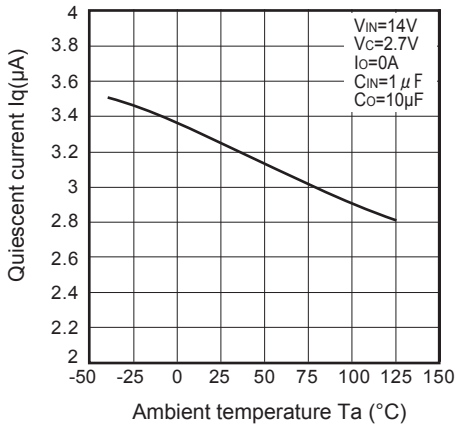

Fig.13 Dropout Voltage vs. Ambient Temperature (PQ120DNA1ZPH)

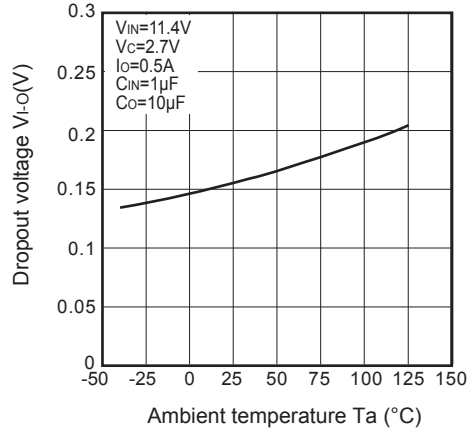

Fig.14 Ripple Rejection vs. Input Ripple Frequency (PQ120DNA1ZPH)

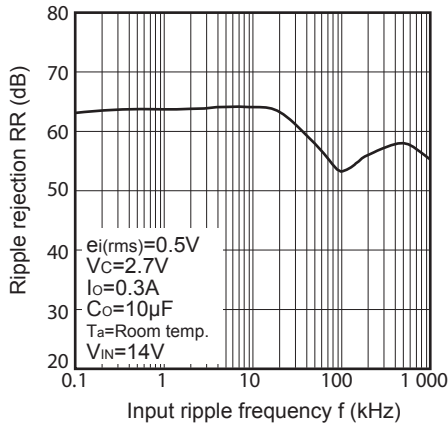

Fig.15 Ripple Rejection vs. Output Current (PQ120DNA1ZPH)

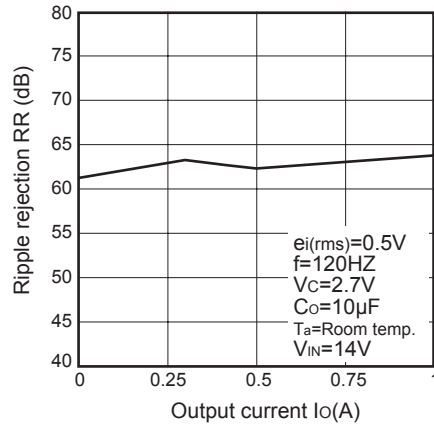
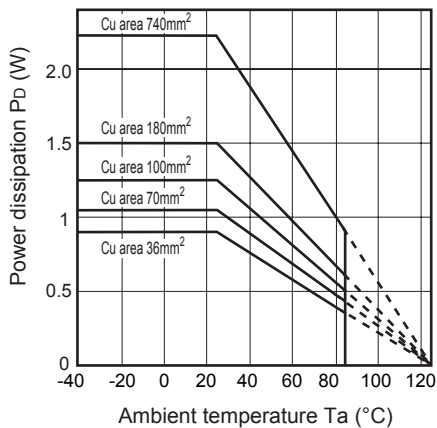
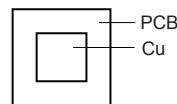

Fig.16 Power Dissipation vs. Ambient Temperature (Typical Value)



Mounting PCB



Material : Glass-cloth epoxy resin
 Size : 50×50×1.6mm
 Cu thickness : 35µm