



Chipsmall Limited consists of a professional team with an average of over 10 year of expertise in the distribution of electronic components. Based in Hongkong, we have already established firm and mutual-benefit business relationships with customers from,Europe,America and south Asia,supplying obsolete and hard-to-find components to meet their specific needs.

With the principle of "Quality Parts,Customers Priority,Honest Operation,and Considerate Service",our business mainly focus on the distribution of electronic components. Line cards we deal with include Microchip,ALPS,ROHM,Xilinx,Pulse,ON,Everlight and Freescale. Main products comprise IC,Modules,Potentiometer,IC Socket,Relay,Connector.Our parts cover such applications as commercial,industrial, and automotives areas.

We are looking forward to setting up business relationship with you and hope to provide you with the best service and solution. Let us make a better world for our industry!



Contact us

Tel: +86-755-8981 8866 Fax: +86-755-8427 6832

Email & Skype: info@chipsmall.com Web: www.chipsmall.com

Address: A1208, Overseas Decoration Building, #122 Zhenhua RD., Futian, Shenzhen, China



PQ035ZN01ZPH

Low Voltage Operation, Compact Surface Mount type Low Power-Loss Voltage Regulator

■ Features

- 1.Low voltage output
($V_O=0.8$ to $1.2V$)
- 2.Low voltage operation: $V_{IN(MIN)}=1.7V$
- 3.Output current : 1A
- 4.Built-in overcurrent and overheat protection functions
- 5.Conform to Flow Soldering SC-63 package
- 6.Ceramic capacitor compatible
- 7.RoHS directive compliant

■ Applications

- 1.AV equipment
- 2.OA equipment

■ Absolute Maximum Ratings

($T_a=25^\circ C$)

Parameter	Symbol	Rating	Unit
*1 Input voltage	V_{IN}	5.5	V
*1 Bias supply voltage	V_B	7	V
*1 Output adjustment terminal voltage	V_{adj}	5	V
Output current	I_o	1	A
*2 Power dissipation	P_D	8	W
*3 Junction temperature	T_j	150	$^\circ C$
Operating temperature	T_{opr}	-40 to +85	$^\circ C$
Storage temperature	T_{stg}	-40 to +150	$^\circ C$
Soldering temperature	T_{sol}	260(10s)	$^\circ C$

*1 All are open except GND and applicable terminals.

*2 P_D :With infinite heat sink

*3 There is case that over heat protection function operates at the temperature $T_j=125^\circ C$ to $150^\circ C$,this item cannot be used in this temperature range.

■ Outline Dimensions

(Unit : mm)

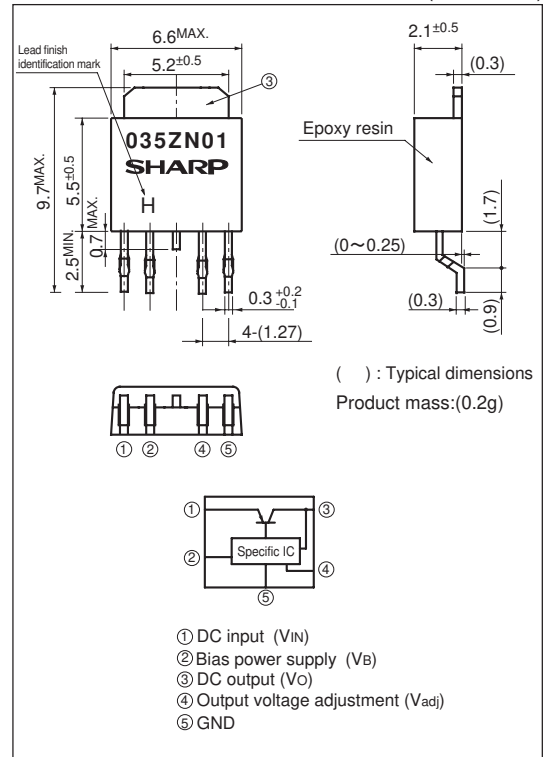

Lead finish:Lead-free solder plating
(Composition: Sn2Cu)

Notice The content of data sheet is subject to change without prior notice.

In the absence of confirmation by device specification sheets, SHARP takes no responsibility for any defects that may occur in equipment using any SHARP devices shown in catalogs, data books, etc. Contact SHARP in order to obtain the latest device specification sheets before using any SHARP device.

■ Electrical Characteristics

Unless otherwise specified, condition shall be $V_{IN}=1.8V, V_B=3.3V, V_O=1.2V(R_1=1k\Omega), I_O=0.5A, T_a=25^\circ C$

Parameter	Symbol	Conditions	MIN.	TYP.	MAX.	Unit
Input voltage	V_{IN}	$0.8V \leq V_O \leq 1.2V$	1.7	-	5.5	V
		$1.2V < V_O \leq 3.5V$	$V_O+0.5$	-	5.5	V
Bias supply voltage	V_B	-	2.35	-	7.0	V
Output voltage	V_O	-	0.8	-	3.5	V
Load regulation	Reg_L	$I_O=5mA$ to 1A	-	0.2	0.5	%
Line regulation	Reg_l	$V_{IN}=1.7V$ to 5.5V, $V_B=2.35$ to 7V, $I_O=5mA$	-	0.3	0.7	%
Reference voltage	V_{ref}	-	0.57	0.6	0.63	V
Temperature coefficient of reference voltage	$T_C V_{ref}$	$T_j=0$ to $+125^\circ C, I_O=5mA$	-	± 0.5	-	%
Ripple rejection	RR1	Refer to Fig.2	-	65	-	dB
	RR2	Refer to Fig.3	-	53	-	dB
Bias power supply input current	I_B	$I_O=0A$	-	1.5	2	mA

Fig.1 Test Circuit

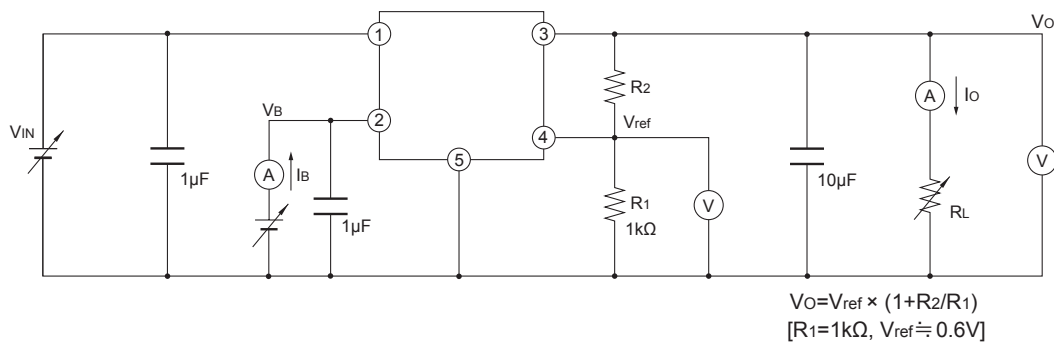

Fig.2 Test Circuit for Ripple Rejection (1)

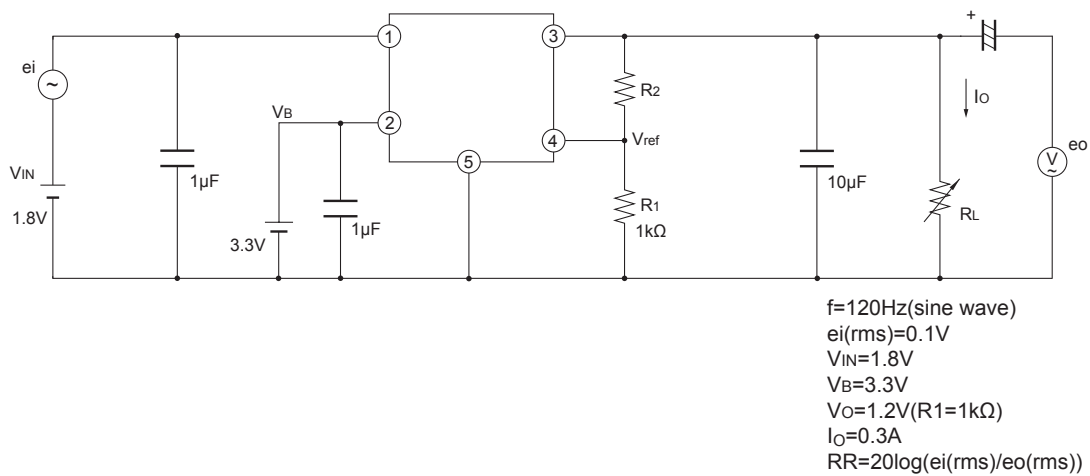

Fig.3 Test Circuit for Ripple Rejection (2)

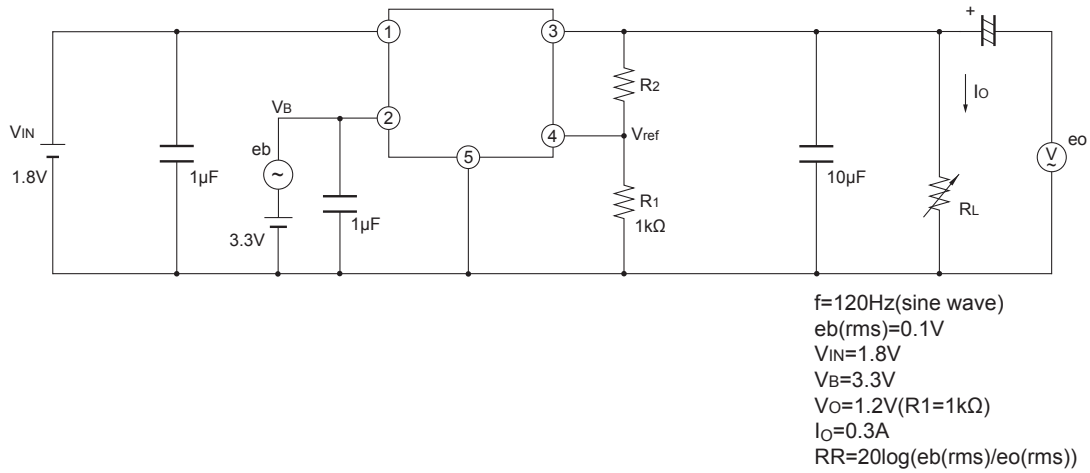

Fig.4 Power Dissipation vs. Ambient Temperature

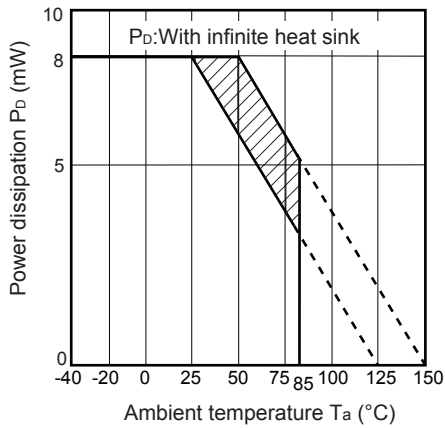

Fig.5 Overcurrent Protection Characteristics

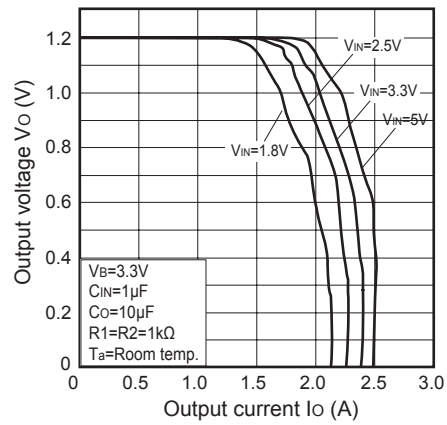

Fig.6 Reference Voltage vs. Ambient Temperature

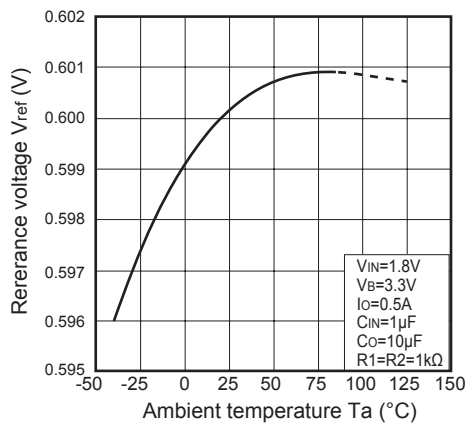

Fig.7 Load Regulation vs. Ambient Temperature

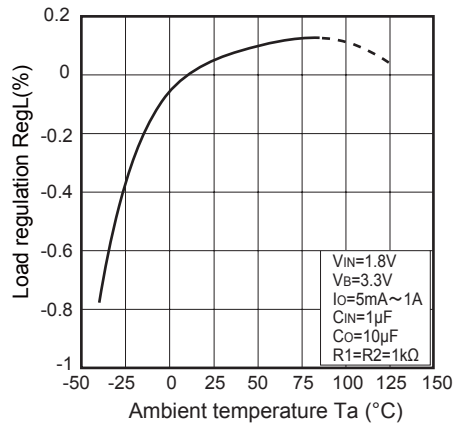

Fig.8 Line Regulation vs. Ambient Temperature

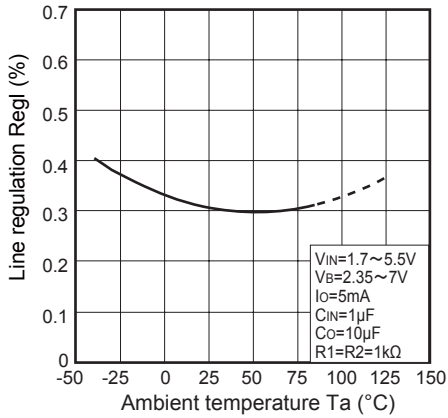

Fig.9 Bias Inflow Current vs. Ambient Temperature

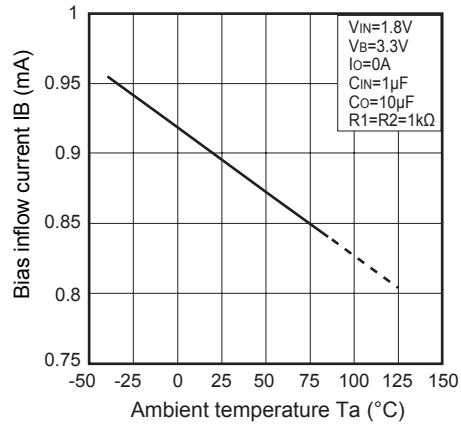

Fig.10 Short circuit Current vs. Ambient Temperature

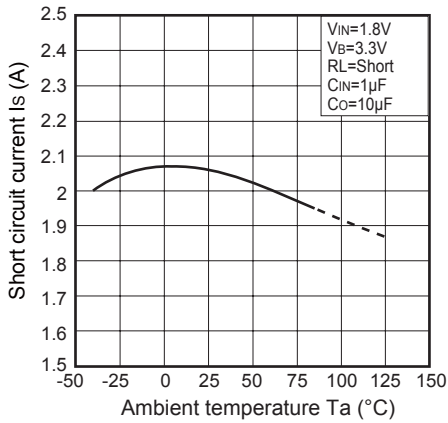

Fig.11 Output Voltage vs. Input Voltage

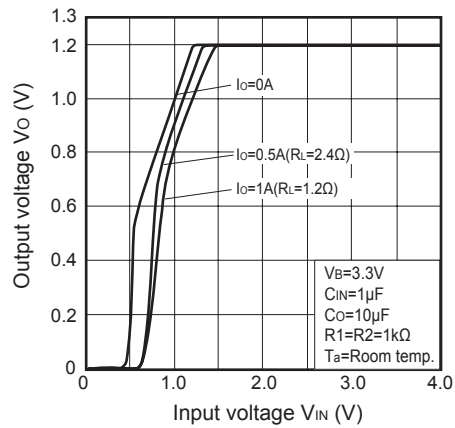

Fig.12 Output Voltage vs. Bias Supply Voltage

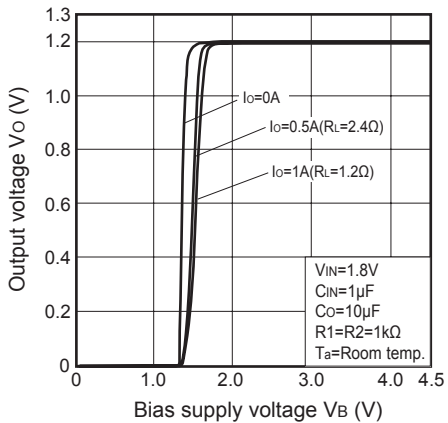

Fig.13 Dropout Voltage vs. Ambient Temperature

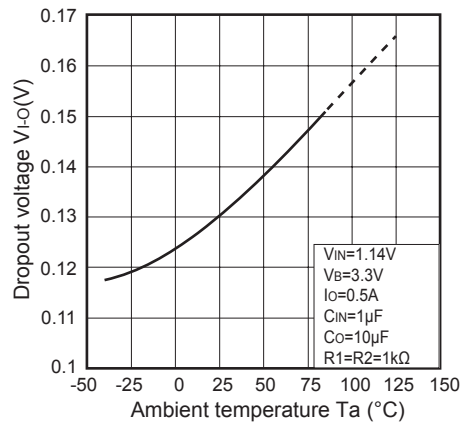

Fig.14 Output Voltage Deviation vs. Output Current

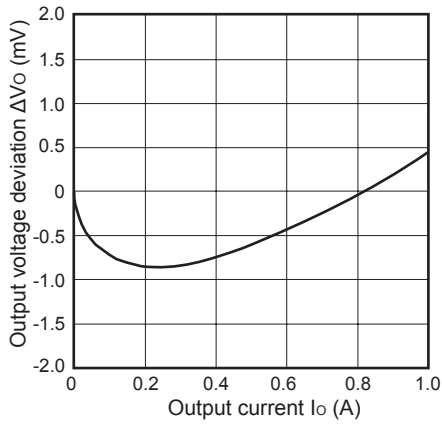

Fig.15 Output Voltage Deviation vs. Input Voltage / Bias Supply Voltage

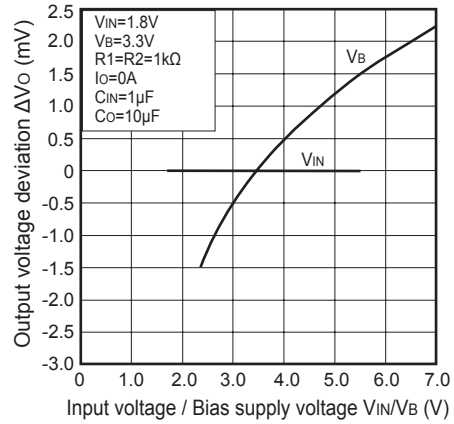

Fig.16 Input Current vs. Input Voltage

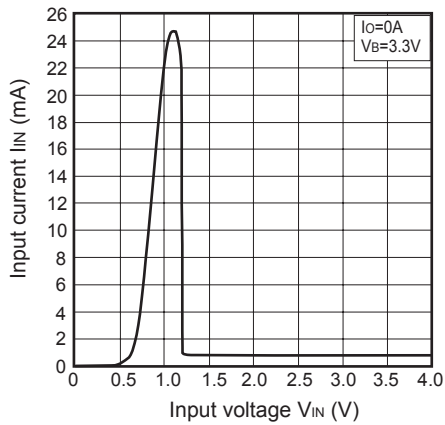

Fig.17 Bias Inflow Current vs. Input Voltage

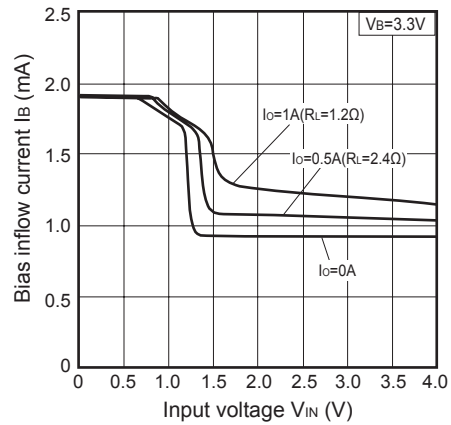

Fig.18 Bias Inflow Current vs. Bias Supply Voltage

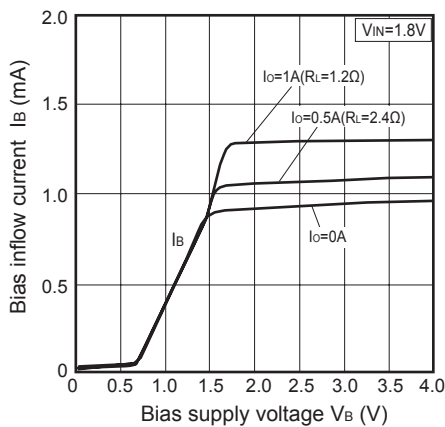

Fig.19 Output Voltage Adjustment Characteristics(Typical Value)

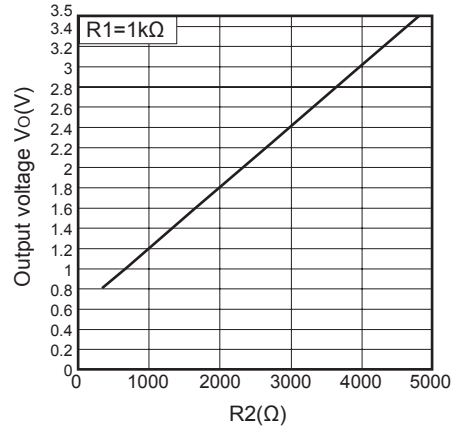
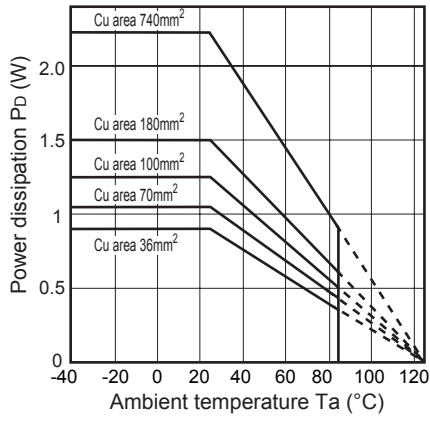
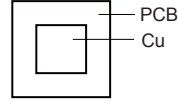

Fig.20 Power Dissipation vs. Ambient Temperature (Typical Value)



Mounting PCB



Material : Glass-cloth epoxy resin
 Size : 50×50×1.6mm
 Cu thickness : 35μm