



Chipsmall Limited consists of a professional team with an average of over 10 year of expertise in the distribution of electronic components. Based in Hongkong, we have already established firm and mutual-benefit business relationships with customers from,Europe,America and south Asia,supplying obsolete and hard-to-find components to meet their specific needs.

With the principle of "Quality Parts,Customers Priority,Honest Operation,and Considerate Service",our business mainly focus on the distribution of electronic components. Line cards we deal with include Microchip,ALPS,ROHM,Xilinx,Pulse,ON,Everlight and Freescale. Main products comprise IC,Modules,Potentiometer,IC Socket,Relay,Connector.Our parts cover such applications as commercial,industrial, and automotives areas.

We are looking forward to setting up business relationship with you and hope to provide you with the best service and solution. Let us make a better world for our industry!



## Contact us

Tel: +86-755-8981 8866 Fax: +86-755-8427 6832

Email & Skype: info@chipsmall.com Web: www.chipsmall.com

Address: A1208, Overseas Decoration Building, #122 Zhenhua RD., Futian, Shenzhen, China



# PQxxDZ51J00H Series/PQxxDZ11J00H Series PQ3DZ53J000H/PQ3DZ13J000H

0.5A/1.0A Output, Surface Mount type  
Low Power-Loss Voltage Regulators

## ■ Features

1. Low power-loss  
(Dropout voltage: MAX.0.5V)
2. Surface mount package (equivalent to SC-63)
3. Output voltage precision: ±3.0%
4. Built-in ON/OFF control function
5. Low dissipation current at OFF-state (I<sub>qs</sub>: MAX.5μA)
6. Built-in overcurrent protection, overheat protection function, ASO protection function
7. RoHS directive compliant

## ■ Applications

1. Personal computers
2. CD-ROM drivers
3. Power supplies for various OA equipment

## ■ Model Line-up

Output current (I <sub>o</sub> )	Package type	Output voltage (V <sub>o</sub> )		
		3.3V	5.0V	9.0V
0.5A	Taping	PQ3DZ53UJ00H	PQ05DZ5UJ00H	PQ09DZ5UJ00H
	Sleeve	PQ3DZ53J000H	PQ05DZ51J00H	PQ09DZ51J00H
1A	Taping	PQ3DZ13UJ00H	PQ05DZ1UJ00H	PQ09DZ1UJ00H
	Sleeve	PQ3DZ13J000H	PQ05DZ11J00H	PQ09DZ11J00H
		12.0V		
0.5A	Taping	PQ12DZ5UJ00H		
	Sleeve	PQ12DZ51J00H		
1A	Taping	PQ12DZ1UJ00H		
	Sleeve	PQ12DZ11J00H		

## ■ Outline Dimensions

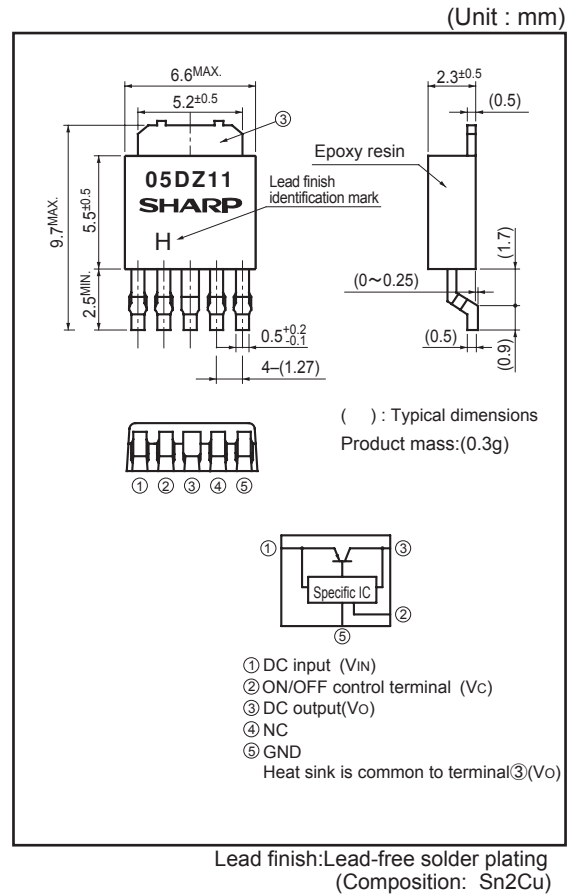

## ■ Absolute Maximum Ratings (T<sub>a</sub>=25°C)

Parameter	Symbol	Rating	Unit
*1 Input voltage	V <sub>IN</sub>	24	V
*1 ON/OFF control terminal voltage	V <sub>C</sub>	24	V
Output current	I <sub>o</sub>	0.5	A
		1.0	
*2 Power dissipation	P <sub>D</sub>	8	W
*3 Junction temperature	T <sub>J</sub>	150	°C
Operating temperature	T <sub>opr</sub>	-20 ~ +80	°C
Storage temperature	T <sub>stg</sub>	-40 ~ +150	°C
Soldering temperature	T <sub>sol</sub>	260 (10s)	°C

\*1 All are open except GND and applicable terminals.

\*2 P<sub>D</sub>: With infinite heat sink

\*3 There is case that overheat protection function operates at the T<sub>J</sub>: 125°C to 150°C, this item cannot be used in this temperature range.

Notice The content of data sheet is subject to change without prior notice.

In the absence of confirmation by device specification sheets, SHARP takes no responsibility for any defects that may occur in equipment using any SHARP devices shown in catalogs, data books, etc. Contact SHARP in order to obtain the latest device specification sheets before using any SHARP device.

### Electrical Characteristics

(Unless otherwise specified, condition shall be  $V_C=2.7V, I_O=0.3A$  [PQxxDZ51J00H series/PQ3DZ53J000H],  $I_O=0.5A$  [PQxxDZ11J00H series/PQ3DZ13J000H],  $T_a=25^\circ C$ )

Parameter	Symbol	Conditions	MIN.	TYP.	MAX.	Unit	
Output voltage	$V_O$	*4	PQ3DZ53J000H/PQ3DZ13J000H	3.201	3.3	3.399	V
			PQ05DZ51J00H/PQ05DZ11J00H	4.85	5.0	5.15	
			PQ09DZ51J00H/PQ09DZ11J00H	8.73	9.0	9.27	
			PQ12DZ51J00H/PQ12DZ11J00H	11.64	12.0	12.36	
Load regulation	$R_{regL}$	$I_O=5mA$ to $0.5A$ *4	—	*8 0.2	2.0	%	
		$I_O=5mA$ to $1.0A$ *4	—	—	—		
Line regulation	$R_{regI}$	*5, $I_O=5mA$	—	*8 0.1	2.5	%	
Temperature coefficient of output voltage	$T_C V_O$	$T_j=0$ to $125^\circ C, I_O=5mA, *4$	—	*9 $\pm 0.01$	—	%/ $^\circ C$	
Ripple Rejection	RR	Refer to Fig.2	45	60	—	dB	
Dropout voltage	$V_{I-O}$	*6, $I_O=0.3A$	—	*8 0.2	0.5	V	
		*6, $I_O=0.5A$	—	—	—		
*7 ON-state voltage for control	$V_{C(ON)}$	*4	2.0	—	—	V	
ON-state current for control	$I_{C(ON)}$	*4	—	—	200	$\mu A$	
OFF-state voltage for control	$V_{C(OFF)}$	$I_O=0A, *4$	—	—	0.8	V	
OFF-state current for control	$I_{C(OFF)}$	$V_C=0.4V, I_O=0A, *4$	—	—	2	$\mu A$	
Quiescent current	$I_q$	$I_O=0A, *4$	—	*8 4	10	mA	
Output OFF-state dissipation current	$I_{qs}$	$V_C=0.4V, I_O=0A, *4$	—	—	5	$\mu A$	

\*4 PQ3DZ53J000H/PQ3DZ13J000H:  $V_{IN}=5V, PQ05DZ51J00H/11J00H: V_{IN}=7V, PQ09DZ51J00H/11J00H: V_{IN}=11V, PQ12DZ51J00H/11J00H: V_{IN}=14V$

\*5 PQ3DZ53J000H/13J000H:  $V_{IN}=4$  to  $10V, PQ05DZ51J00H/11J00H: V_{IN}=6$  to  $16V, PQ09DZ51J00H/11J00H: V_{IN}=10$  to  $20V, PQ12DZ51J00H/11J00H: V_{IN}=13$  to  $23V$

\*6 Input voltage shall be the value when output voltage is 95% in comparison with the initial value. PQ3DZ53J000H/13J000H:  $V_{IN}=3.7V$

\*7 In case of opening control terminal ②, output voltage turns off.

\*8 Applied only to PQ05DZ51J00H/11J00H.

\*9 PQ3DZ53J000H/PQ3DZ13J000H:  $\pm 0.02$

Fig.1 Test Circuit

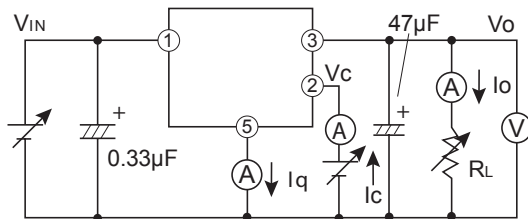

Fig.2 Test Circuit for Ripple Rejection

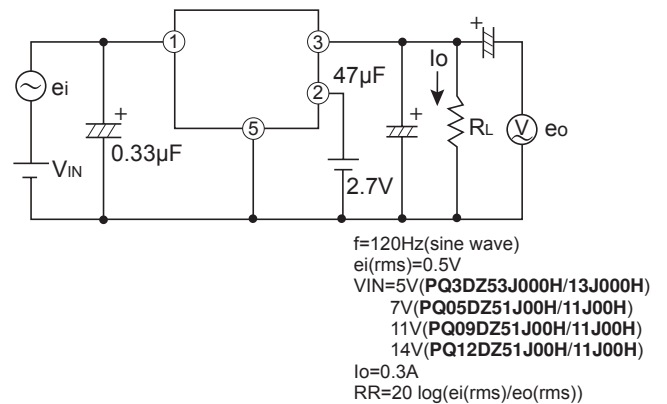
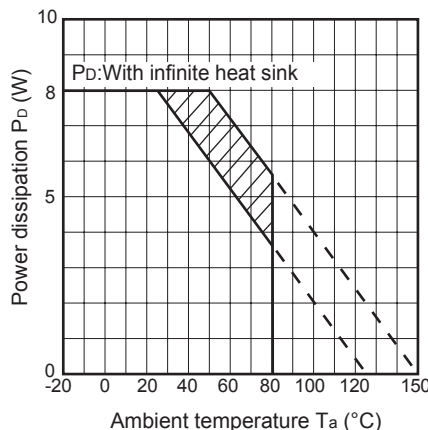

Fig.3 Power Dissipation vs. Ambient Temperature



Note) Oblique line portion: Overheat protection may operate in this area.

Fig.4 Overcurrent Protection Characteristics (Typical Value) (PQ3DZ53J000H)

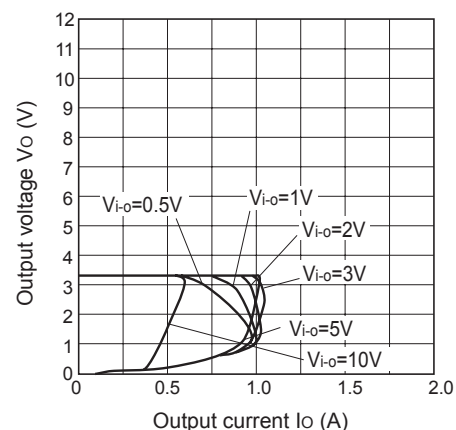

Fig.5 Overcurrent Protection Characteristics (Typical Value) (PQ3DZ13J000H)

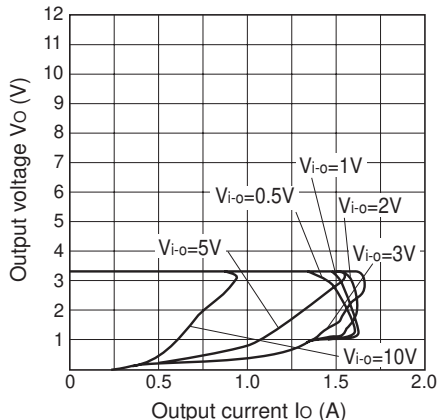

Fig.6 Overcurrent Protection Characteristics (Typical Value) (PQ05DZ51J00H)

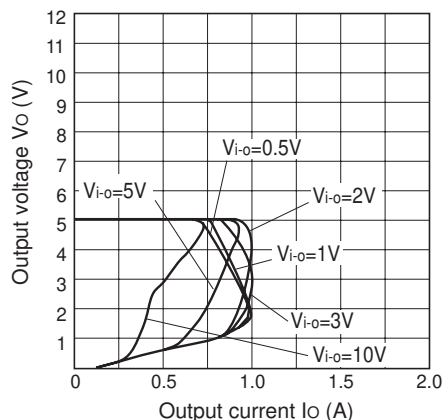

Fig.7 Overcurrent Protection Characteristics (Typical Value) (PQ09DZ51J00H)

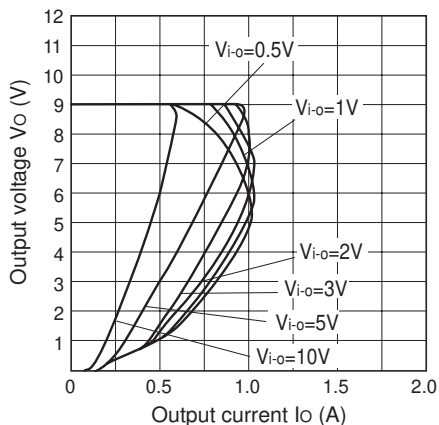

Fig.8 Overcurrent Protection Characteristics (Typical Value) (PQ12DZ51J00H)

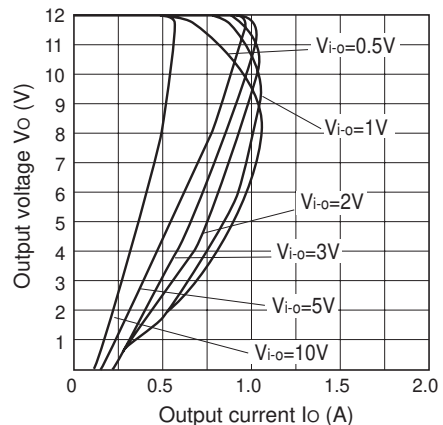

Fig.9 Overcurrent Protection Characteristics (Typical Value) (PQ05DZ11J00H)

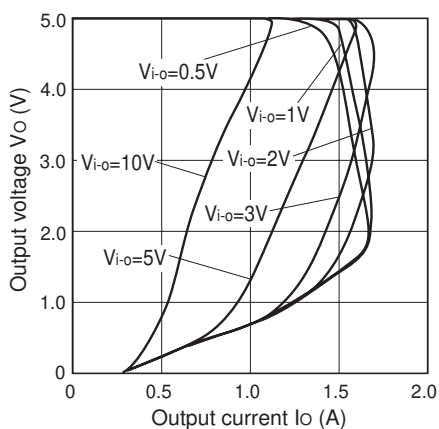

Fig.10 Overcurrent Protection Characteristics (Typical Value) (PQ09DZ11J00H)

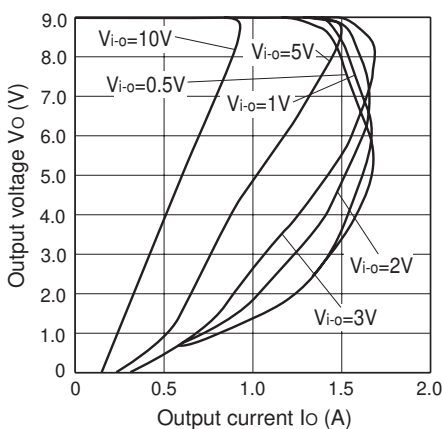

Fig.11 Overcurrent Protection Characteristics (Typical Value) (PQ12DZ11J00H)

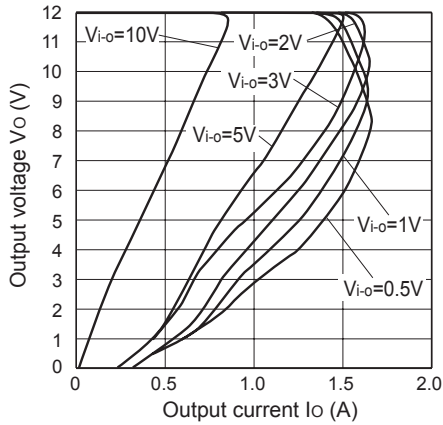
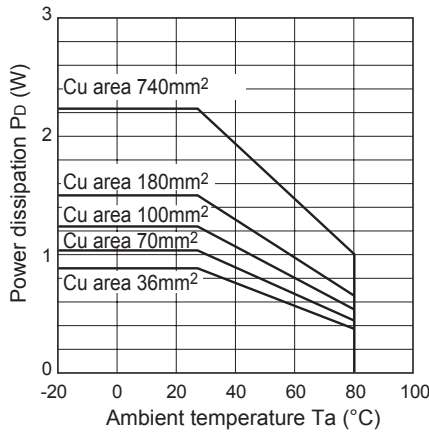
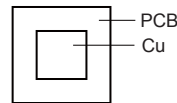

Fig.12 Power Dissipation vs. Ambient Temperature (Typical Value)



Mounting PCB



Material : Glass-cloth epoxy resin  
Size : 50×50×1.6mm  
Cu thickness : 35μm

Fig.13 Output Voltage Deviation vs. Junction Temperature (PQ3DZ53J000H/PQ3DZ13J000H)

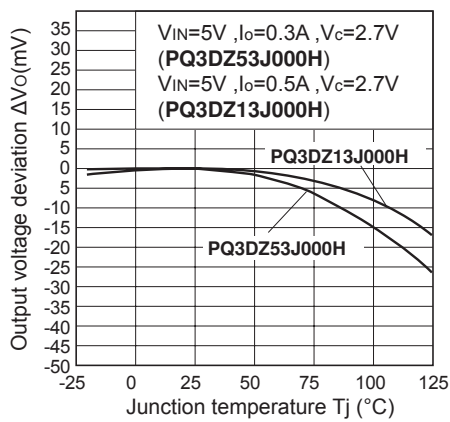

Fig.14 Output Voltage Deviation vs. Junction Temperature (PQ05DZ51J00H/PQ05DZ11J00H)

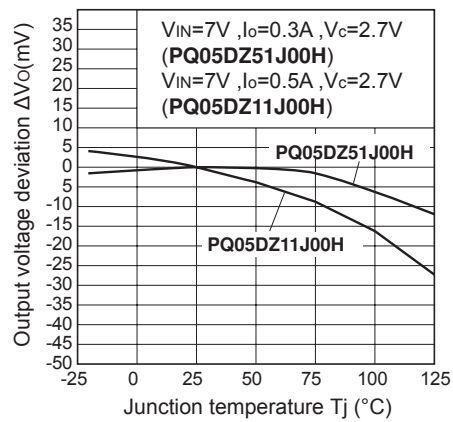

Fig.15 Output Voltage Deviation vs. Junction Temperature  
 (PQ09DZ51J00H/PQ09DZ11J00H)

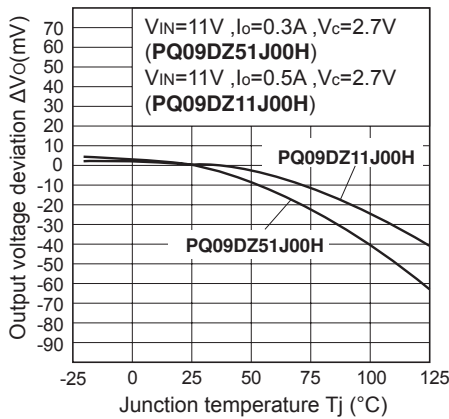

Fig.16 Output Voltage Deviation vs. Junction Temperature  
 (PQ12DZ51J00H/PQ12DZ11J00H)

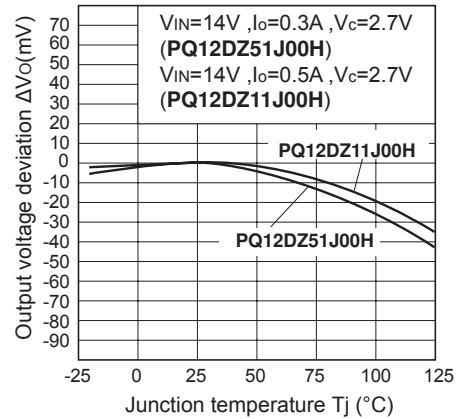

Fig.17 Output Voltage vs. Input Voltage  
 (Typical Value) (PQ3DZ53J000H)

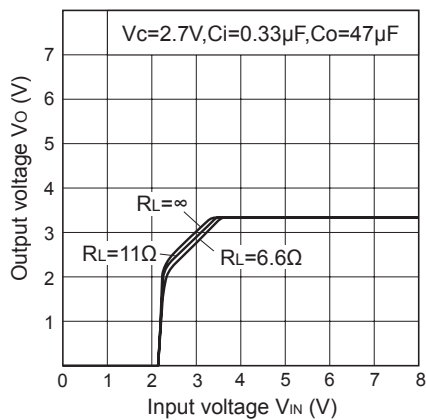

Fig.18 Output Voltage vs. Input Voltage  
 (Typical Value) (PQ05DZ51J00H)

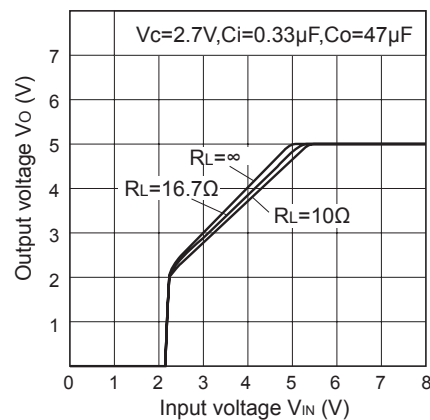

Fig.19 Output Voltage vs. Input Voltage  
 (Typical Value) (PQ09DZ51J00H)

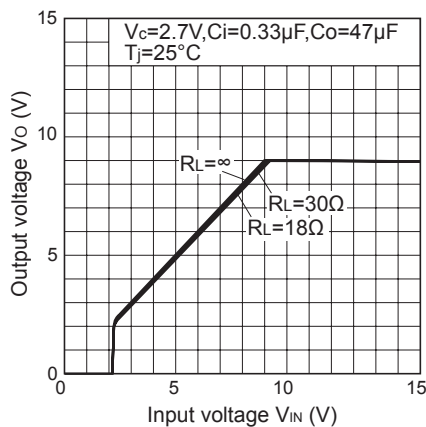

Fig.20 Output Voltage vs. Input Voltage  
 (Typical Value) (PQ12DZ51J00H)

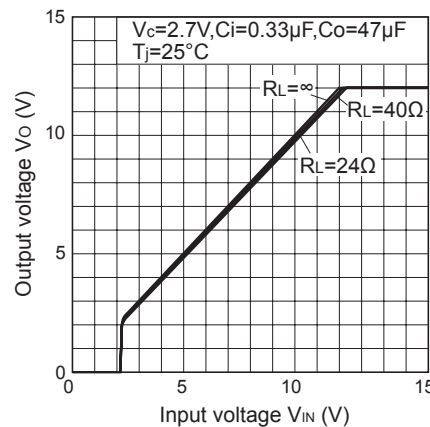

Fig.21 Output Voltage vs. Input Voltage (Typical Value) (PQ3DZ13J000H)

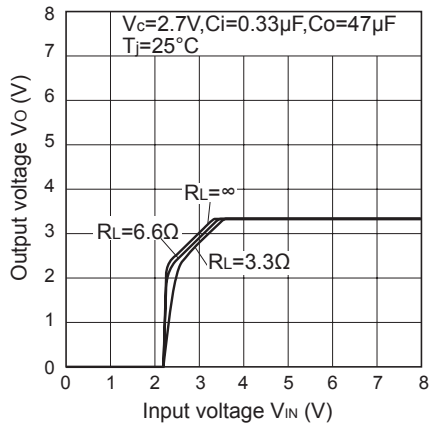

Fig.22 Output Voltage vs. Input Voltage (Typical Value) (PQ05DZ11J00H)

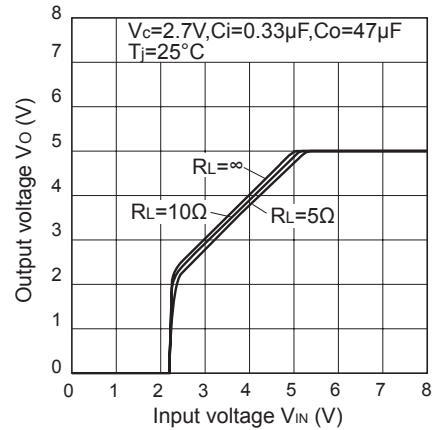

Fig.23 Output Voltage vs. Input Voltage (Typical Value) (PQ09DZ11J00H)

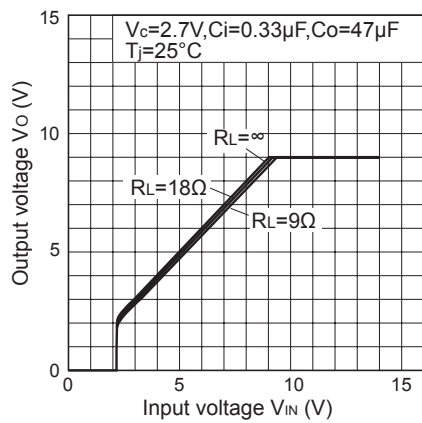

Fig.24 Output Voltage vs. Input Voltage (Typical Value) (PQ12DZ11J00H)

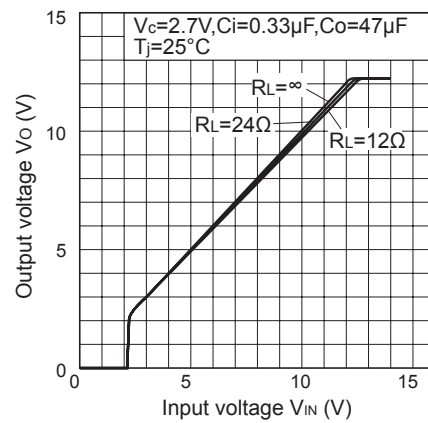

Fig.25 Circuit Operating Current vs. Input Voltage (PQ3D53J000H)

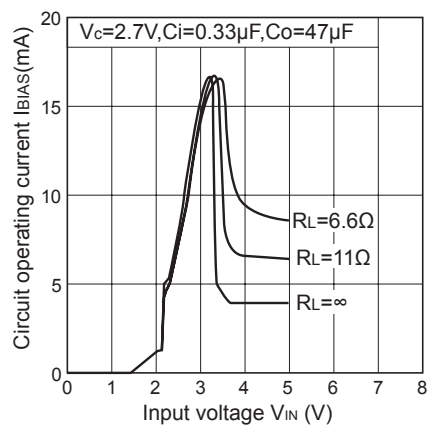

Fig.26 Circuit Operating Current vs. Input Voltage (PQ05D51J00H)

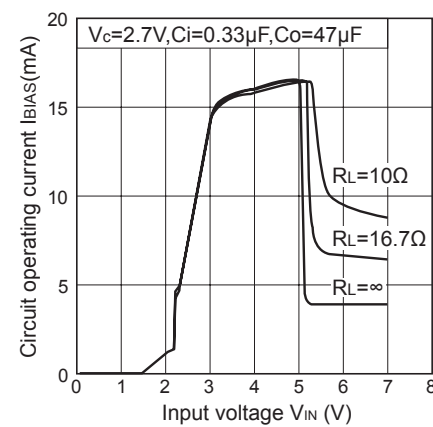

Fig.27 Circuit Operating Current vs. Input Voltage(PQ09DZ51J00H)

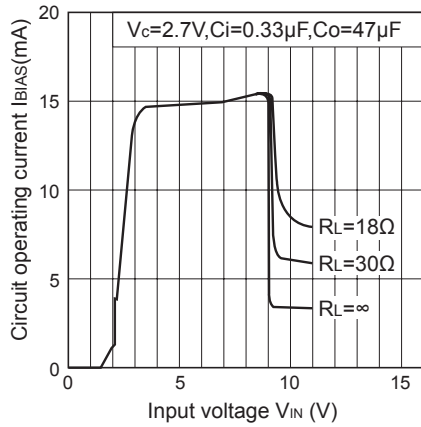

Fig.28 Circuit Operating Current vs. Input Voltage(PQ12DZ51J00H)

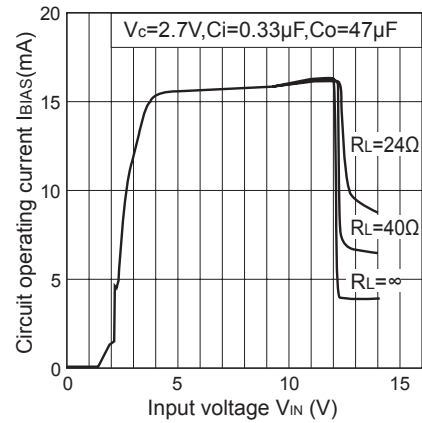

Fig.29 Circuit Operating Current vs. Input Voltage(PQ3DZ13J000H)

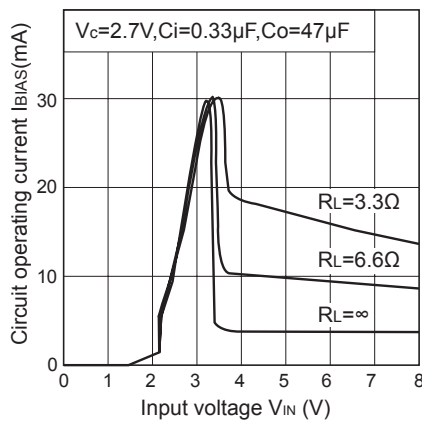

Fig.30 Circuit Operating Current vs. Input Voltage(PQ05DZ11J00H)

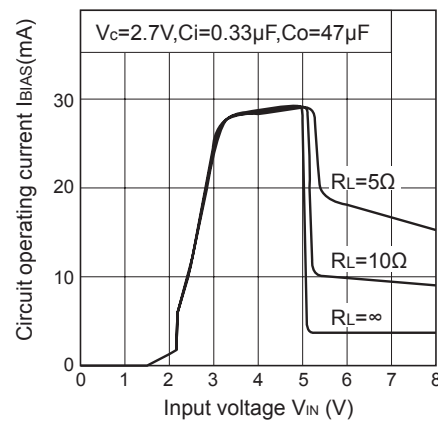

Fig.31 Circuit Operating Current vs. Input Voltage(PQ09DZ11J00H)

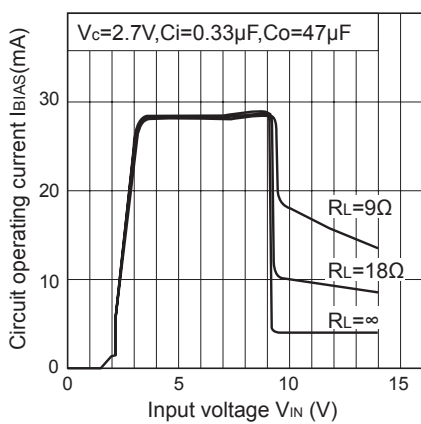

Fig.32 Circuit Operating Current vs. Input Voltage(PQ12DZ11J00H)

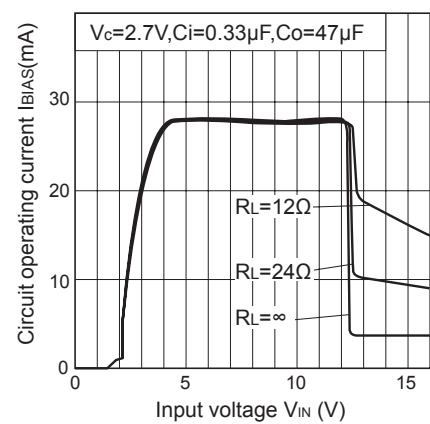



Fig.33 Dropout Voltage vs. Junction Temperature (PQxxDZ51J00H series/PD3DZ53J000H)

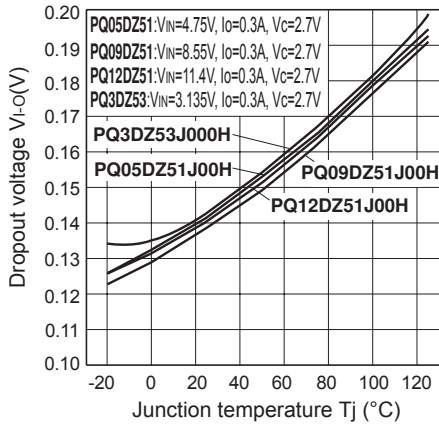

Fig.34 Dropout Voltage vs. Junction Temperature (PQxxDZ11J00H series/PD3DZ13J000H)

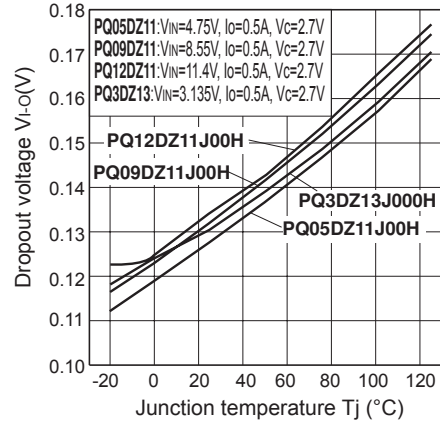

Fig.35 Quiescent Current vs. Junction Temperature (PQxxDZ51J00H series/PQ3DZ53J000H)

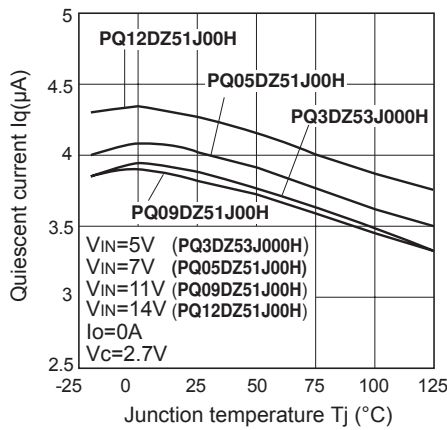

Fig.36 Quiescent Current vs. Junction Temperature (PQxxDZ11J00H series/PQ3DZ13J000H)

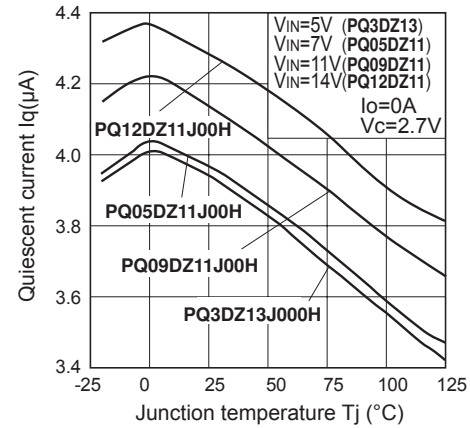

Fig.37 Ripple Rejection vs. Input Ripple Frequency (PQxxDZ51J00H series/PQ3DZ53J000H)

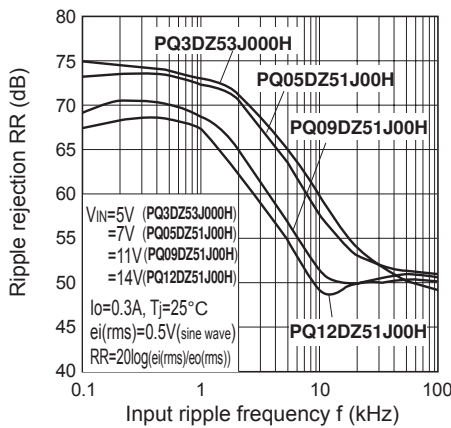

Fig.38 Ripple Rejection vs. Input Ripple Frequency (PQxxDZ11J00H series/PQ3DZ13J000H)

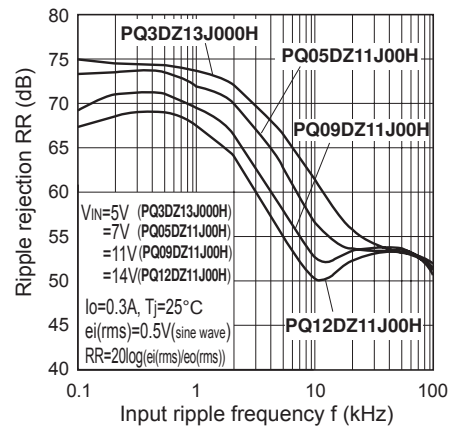

Fig.39 Ripple Rejection vs. Output Current  
(PQxxDZ51J00H series/PQ3DZ53J000H)

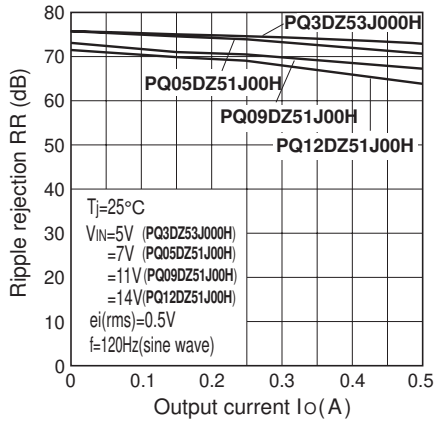
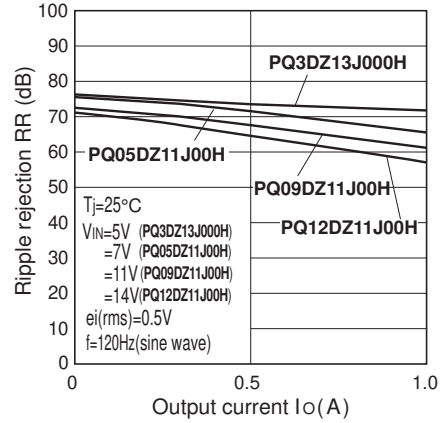

Fig.40 Ripple Rejection vs. Output Current  
(PQxxDZ11J00H series/PQ3DZ13J000H)



■ Typical Application

