



Chipsmall Limited consists of a professional team with an average of over 10 year of expertise in the distribution of electronic components. Based in Hongkong, we have already established firm and mutual-benefit business relationships with customers from,Europe,America and south Asia,supplying obsolete and hard-to-find components to meet their specific needs.

With the principle of “Quality Parts,Customers Priority,Honest Operation,and Considerate Service”,our business mainly focus on the distribution of electronic components. Line cards we deal with include Microchip,ALPS,ROHM,Xilinx,Pulse,ON,Everlight and Freescale. Main products comprise IC,Modules,Potentiometer,IC Socket,Relay,Connector.Our parts cover such applications as commercial,industrial, and automotives areas.

We are looking forward to setting up business relationship with you and hope to provide you with the best service and solution. Let us make a better world for our industry!



Contact us

Tel: +86-755-8981 8866 Fax: +86-755-8427 6832

Email & Skype: info@chipsmall.com Web: www.chipsmall.com

Address: A1208, Overseas Decoration Building, #122 Zhenhua RD., Futian, Shenzhen, China



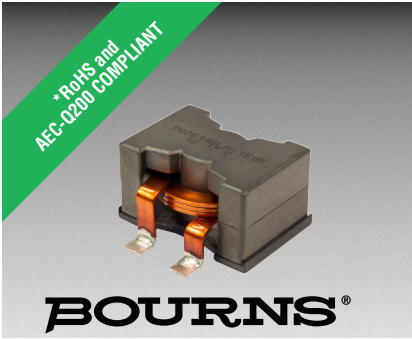

Features

- Magnetically shielded
- Flat wirewound
- Low DCR
- High saturation current
- Extra solder pad for increased mechanical stability
- AEC-Q200 compliant
- RoHS compliant* and halogen free**

Applications

- Automotive - power conversion
- DC/DC converters
- Switch-mode power supplies
- High current Point-of-Load

PQ2614BLA/BHA Series - Shielded Power Inductors

Electrical Specifications @ 25 °C

Bourns Part Number	Inductance @ 100 kHz / 0.1 V		SRF (MHz) Typ.	DCR (mΩ) Typ.	DCR (mΩ) Max.	I _{rms} (A) Typ.	Isat1 (A) Typ.	Isat2 (A) Typ.
	L (μH)	Tol. (%)						
PQ2614BLA-1R0K	1.0	± 10	61	0.85	1.20	30	>100	>100
PQ2614BLA-1R5K	1.5	± 10	60	1.29	1.60	30	>100	>100
PQ2614BHA-2R2K	2.2	± 10	40	1.62	1.90	30	>100	>100
PQ2614BLA-2R2K	2.2	± 10	50	1.29	1.60	30	84.0	84.8
PQ2614BHA-3R3K	3.3	± 10	30	1.62	1.90	30	66.9	68.4
PQ2614BLA-3R3K	3.3	± 10	40	1.29	1.60	30	54.0	57.0
PQ2614BHA-4R7K	4.7	± 10	25	1.62	1.90	30	48.0	50.1
PQ2614BLA-4R7K	4.7	± 10	30	1.29	1.60	30	36.9	39.0
PQ2614BHA-6R8K	6.8	± 10	20	1.62	1.90	30	34.5	36.2
PQ2614BLA-6R8K	6.8	± 10	25	1.29	1.60	30	26.0	27.8
PQ2614BHA-100K	10	± 10	15	1.62	1.90	30	21.5	23.4
PQ2614BLA-100K	10	± 10	20	1.29	1.60	30	16.2	17.6
PQ2614BHA-150K	15	± 10	12	1.62	1.90	30	14.0	15.2
PQ2614BLA-150K	15	± 10	15	1.29	1.60	30	9.8	11.0
PQ2614BHA-220K	22	± 10	10	1.62	1.90	30	8.6	9.6
PQ2614BLA-220K	22	± 10	10	1.29	1.60	30	6.0	6.8
PQ2614BHA-330K	33	± 10	8	1.62	1.90	30	5.1	5.9
PQ2614BLA-330K	33	± 10	7	1.29	1.60	30	2.6	3.3

How to Order

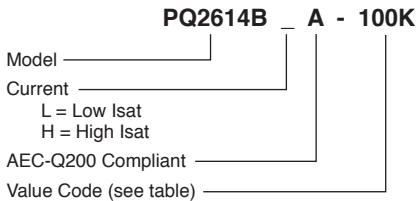

Typical Part Marking

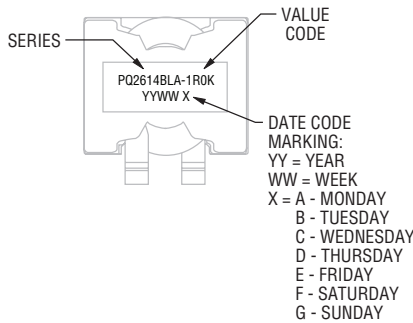

Recommended Layout

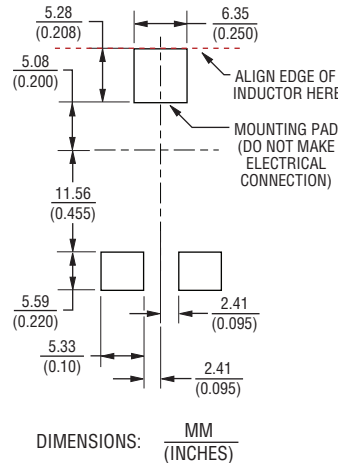

Electrical Schematic

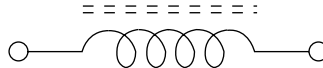

General Specifications

Dielectric Withstand Voltage - Terminal to Core 300 VDC 5 mA max.
 Operating Temperature-40 °C to +155 °C
 (Temperature rise included)
 Storage Temperature (Component)-40 °C to +155 °C
 Rated Current
 Inductance drops 20 % at Isat1
 Inductance drops 30 % at Isat2
 Temperature Rise40 °C at rated I_{rms}
 Moisture Sensitivity Level 1
 ESD Classification (HBM)..... N/A

Materials

Core Ferrite
 Wire Enameled copper
 Terminal Finish Sn
 Packaging 25 pcs/tray

Product Dimensions

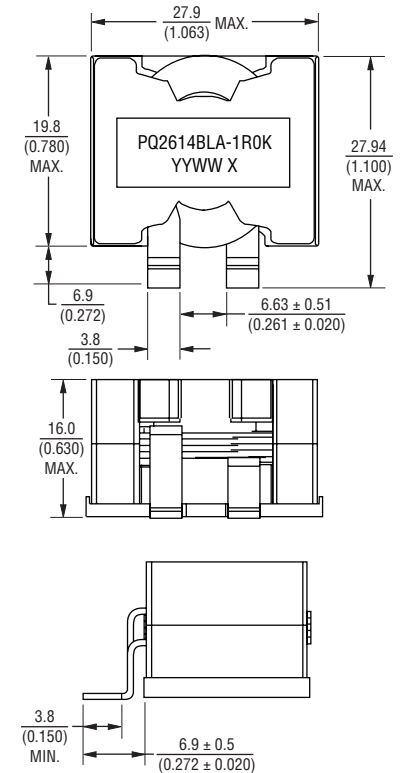

* RoHS Directive 2015/863, Mar 31, 2015 and Annex.

**Bourns considers a product to be "halogen free" if (a) the Bromine (Br) content is 900 ppm or less; (b) the Chlorine (Cl) content is 900 ppm or less; and (c) the total Bromine (Br) and Chlorine (Cl) content is 1500 ppm or less.

Specifications are subject to change without notice.

The device characteristics and parameters in this data sheet can and do vary in different applications and actual device performance may vary over time. Users should verify actual device performance in their specific applications.

Soldering Profile

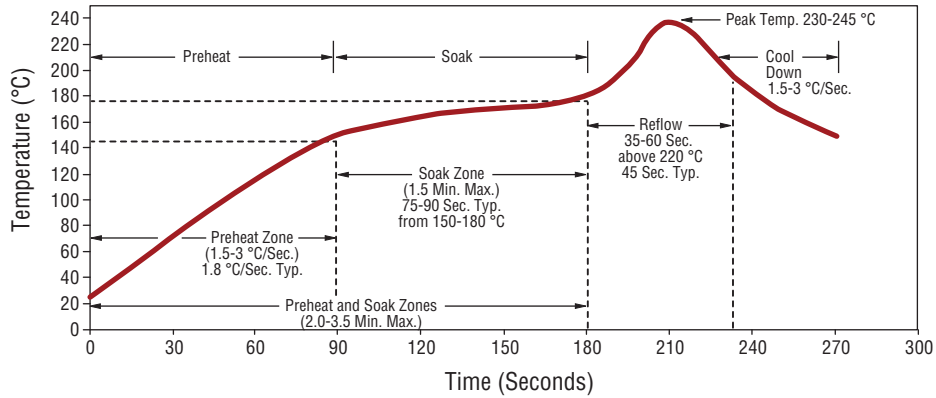

BOURNS®

Asia-Pacific: Tel: +886-2 2562-4117 • Email: asiacus@bourns.com

EMEA: Tel: +36 88 520 390 • Email: eurocus@bourns.com

The Americas: Tel: +1-951 781-5500 • Email: americus@bourns.com

www.bourns.com